

Catalog

Low voltage Motors for explosive atmospheres

Power and productivity
for a better world™



We provide motors and generators, services and expertise to save energy and improve customers' processes over the total lifecycle of our products, and beyond.



Low voltage motors for explosive atmospheres

Sizes 63 to 450, 0.12 to 1000 kW

- 04 General information
- 16 Technical specification
- 27 Flameproof motors Ex d IE2
- 53 Flameproof motors Ex de IE2
- 83 Increased safety motors Ex e IE2
- 113 Non-sparking motors Ex nA IE2/IE3
- 163 Dust ignition proof motors DIP/Ex tD IE2/IE3
- 226 Total product offer
- 227 Visit our web site

ABB reserves the right to change the design, technical specification and dimensions without prior notice.

General information



ATEX Directives 94/9/EC (“95”) and 1999/92/EC (“137”)

ATEX Directives harmonize the safety rules in respect with the free trading principles of the European Community.

The responsibilities are split in two areas between the manufacturers and the end users. The manufacturers have to comply with the ‘Essential Health and Safety Requirements’ of the Products Directive 94/9/EC, or ATEX 95; and the end users must proceed to make an Explosion Protection Document based on risks assessment of their ‘work places’ and ‘work equipment’ to fulfil the ‘minimum requirements’ listed in the Worker Protection Directive 1999/92/EC or ATEX 137.

Motors comply fully with the ATEX product directive 94/9/EC.

According to the regulations, low voltage motors for explosive atmospheres are exempted from the Low Voltage Directive, the EMC directive as well as the Machinery Directive.

IECEX System

The IECEX (International Electrotechnical Commission) System is a certification system which verifies compliance with IEC international standards relating to safety in explosive atmospheres. It covers equipment, service facilities and the competency of personnel.

Created in September 1999, the System aims “to facilitate international trade in equipment and services for use in explosive atmospheres, while maintaining the required level of safety...” (source: IECEX website, www.iecex.com). It is a voluntary system which provides an internationally accepted means of proving that products and services are in compliance with IEC standards. The voluntary and international aspects of the IECEX System differentiate it from certification under ATEX, for example, which is mandatory but applies only within the European Economic Area.

The IECEX System comprises global certification programs for both equipment and service facilities.

The IECEX certification involves

– in addition to the product tests – assessment of quality control procedures and testing plans, audits of manufacturing plants, and routine on-going surveillance and inspections.

In addition, IECEX has established a comprehensive set of operational documents and procedures to develop a single internationally standardized approach to Ex testing and certification. The most important document is IECEX OD02, Rules of procedure for equipment certification.

The approach includes:

- A standardized “IECEX way of Ex Testing and Certification”. There is a single set of operational procedures, and Ex test procedures are always applied in the same way.
- A dedicated Technical and Operational Secretariat to maintain operations. Ex test procedures are evaluated and monitored on a centralized basis.

Who is responsible for the certification work?

A manufacturer needing to have equipment certified under the IECEX System can apply to an IECEX Competent Body (ExCB) in any member country. At present there are 30 IECEX member countries. The ExCB performs or coordinates the activities of certification.

A quality assessment of the manufacturer is undertaken by the ExCB itself, and the auditor issues an IECEX Quality Assessment Report (QAR).

Type testing of product samples is performed on behalf of the ExCB by an IECEX Assessment and Testing Laboratory (ExTL). On completion of its work the ExTL’s assessment engineer prepares an IECEX Test Report (ExTR).

The ExTR is then submitted to the ExCB for endorsement. Based on the QAR and ExTR, the ExCB then issues the Certificate of Conformity (CoC). The CoC provides internationally accepted verification that the equipment in question is in compliance with the relevant IEC standards.

Once formally issued by the ExCB, both the ExTR and QAR are registered on the IECEX Internet site. This provides verification that an ExTR and QAR exist for the product and manufacturer.

How do I know if a motor is IECEX certified?

IECEX certified motors show the certification number on their rating plate, for example: “IECEX LCI 05.0008”. In this case “LCI” indicates that the IECEX Certificate was issued by LCIE, an IECEX approved Certification Body in France.

In addition, IECEX certificates are issued in electronic form and are publicly available on the IECEX website. They can therefore be viewed and printed by anyone with access to the Internet. See ‘Online Certificates’ at www.iecex.com.

IECEX certification is particularly useful in certain markets. In Australia, New Zealand, and Singapore, for example, IECEX certificates are accepted, but not all IEC certificates are accepted. Certain other countries, including Korea and China, are prepared to accept ExTRs as a basis for their own national certificates. There are also many countries that

are willing to accept products covered by current IECEx certificates, even though the countries in question are not members of the IECEx Management Framework.

IECEx Conformity Mark License

The IECEx Conformity Mark System was introduced in 2008. IECEx Conformity Mark Licenses are issued by approved Certification Bodies in IECEx participating countries.

The IECEx Conformity Mark shows that a product has been granted an IECEx Certificate of Conformity. IECEx Certification confirms that the product has the appropriate protection for use in explosive atmospheres and that it has been manufactured under systems subject to ongoing surveillance by Certification Bodies. It is recognized in all the countries participating in the IECEx System, and also means that the product can be supplied to the market without the need for additional tests.

ABB has been granted IECEx Certification for a wide range of low and high voltage motors, and these can therefore display the IECEx Conformity Mark. The hazardous area protection types provided by these motors include

- Flameproof Ex d
- Non-sparking Ex nA
- Dust tight Ex tD

The IECEx Conformity Mark License will considerably enhance ABB's ability to market its products globally. It complements ABB's existing ATEX approval, which is based on two EU Directives governing the use of equipment in potentially explosive atmospheres.

Benefits of IECEx System for endusers

A significant advantage of IECEx is that vendor certificates are available for inspection on the IECEx website. End users can therefore confirm the validity of IECEx certificates at any time - which is not possible with ATEX, for example. This increases end user confidence that the motor vendor will be committed to maintaining the necessary quality systems.

Under quality based IECEx certification approach the interpretation of the standard is shared throughout the 31 participating countries and individual interpretations by Notified Bodies are not allowed. Another advantage of IECEx is that the Certificate of Conformity also covers Zone 2.

Which ABB motors and generators are IECEx certified?

All M3JP/M3KP 80–400 motors with protection type Ex d and Ex de, and all M3GP 80-450 with protection type Ex nA, are IECEx certified.

ABB refers to recently updated standards

In the implementation of ATEX 95 and ATEX 137 directives ABB refers to the IEC and EN standards which have been recently updated. Otherwise ABB refers to IEC standards mentioned in certificates.

Main standards for explosive atmospheres:

IEC/EN 60079-0	Equipment - General requirements
IEC/EN 60079-1	Equipment protection by flameproof enclosures "d"
IEC/EN 60079-7	Equipment protection by increased safety "e"
IEC/EN 60079-15	Equipment protection by type of protection "n"
IEC/EN 60079-31	Equipment dust ignition protection by enclosure "t"
IEC/EN 61241-14	Selection and installation of Ex tD (DIP) equipment
IEC/EN 60079-14	Electrical installations design, selection and erection
IEC/EN 60079-17	Electrical installations inspections and maintenance
IEC/EN 60079-19	Equipment repair, overhaul and reclamation
IEC 60050-426	Equipment for explosive atmospheres
IEC/EN 60079-10	Classification of hazardous area (gas areas)
IEC 60079-10-1	Classification of areas - Explosive gas atmospheres
IEC 60079-10-2	Classification of areas - Combustible dust atmospheres
EN 61241-0	Electrical apparatus for use in the presence of combustible dust
EN 61241-1	Protection by enclosure 'tD'
IEC/EN 61241-10	Classification of area where combustible dusts are or may be present

Note: The very latest revisions of standards, which are not cited hereby, will introduce a "protection level" and thus change the marking of the motors. Some new requirements are also added to several protection types.

Explosive atmospheres

Explosive atmospheres worldwide are classified by zone, according to the risk posed by explosive gas or dust in the atmosphere.

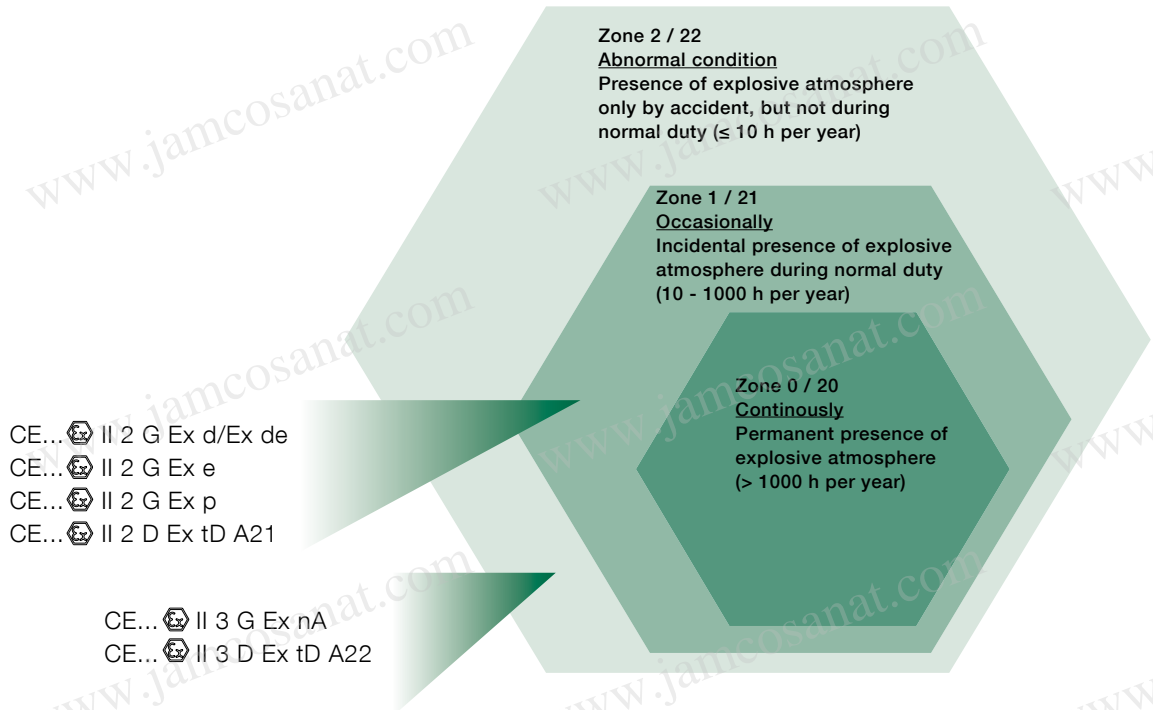

Classification of explosive atmospheres according to CENELEC and IEC

The definition of areas according to the presence of atmosphere are set up in the following standards:

IEC/EN 60079-10-1 Gas
IEC/EN 60079-10-2 Dust

Explosive atmosphere	Permanent presence	Incidental presence (normal operation conditions)	Accidental presence (abnormal operation conditions)
Gas ('G')	Zone 0	Zone 1	Zone 2
Dust ('D' / 'DIP' / 'Ex tD')	Zone 20	Zone 21	Zone 22

Note: In certain countries Ex d and Ex e motors are also used in Zone 2.

Marking temperatures, gas groups and explosive atmospheres

To ensure equipment can be safely used in potentially explosive atmospheres, the explosive atmospheres where the equipment is installed must be known. Temperature class of equipment must be compared with the spontaneous ignition temperature of the gas mixtures concerned and its gas group must be known in specific cases (e.g. flame proof protection).

Categories or classification

The ATEX Directive has introduced the concept of "Categories" which is a way of expressing the capability of equipment respecting the EHSR versus the Zone where the equipment is installed.

Category 1	according to Annex 1 of ATEX 95 used in Zone 0 or Zone 20
Category 2	according to Annex 1 of ATEX 95 used in Zone 1 or 21
Category 3	according to Annex 1 of ATEX 95 used in Zone 2 or 22

Classification

	Category equipment	Inflammable substances	Level of protection	Fault protection	Comparison with present practice and IEC
Equipment group I (mines)	M1	Methane, dust	Very high level	2 types of protection or 2 independent faults	Group I
	M2	Methane, dust	High level	1 type of protection Normal operation	Group I
Equipment group II (surface)	1	Gas, vapours, mist, dust	Very high level	2 types of protection or 2 independent faults	Group II Zone 0 (gas) / Zone 20 (dust)
	2	Gas, vapours, mist, dust	High level	1 type of protection Habitual frequent malfunction	Group II Zone 1 (gas) / Zone 21 (dust)
	3	Gas, vapours, mist, dust	Normal	Required level of protection	Group II Zone 2 (gas) / Zone 22 (dust)

Temperature classes

Temperature class	Ignition temperature for the gas/vapour °C	Max. permitted temperature equipment °C
T1	> 450	450
T2	> 300 < 450	300
T3	> 200 < 300	200
T4	> 135 < 200	135
T5	> 100 < 135	100
T6	> 85 < 100	85

Grouping of electrical apparatus

Group I	Apparatus for coal mines susceptible to firedamp
Group II	Apparatus for explosive atmospheres other than mines; surface industries
IIA, IIB, IIC	Group II is subdivided for Ex d and Ex i -equipment according to the severity of the environment. IIC is the highest rating; a motor from one of the higher categories can also be used in a lower category environment

Marking of equipment according to ATEX

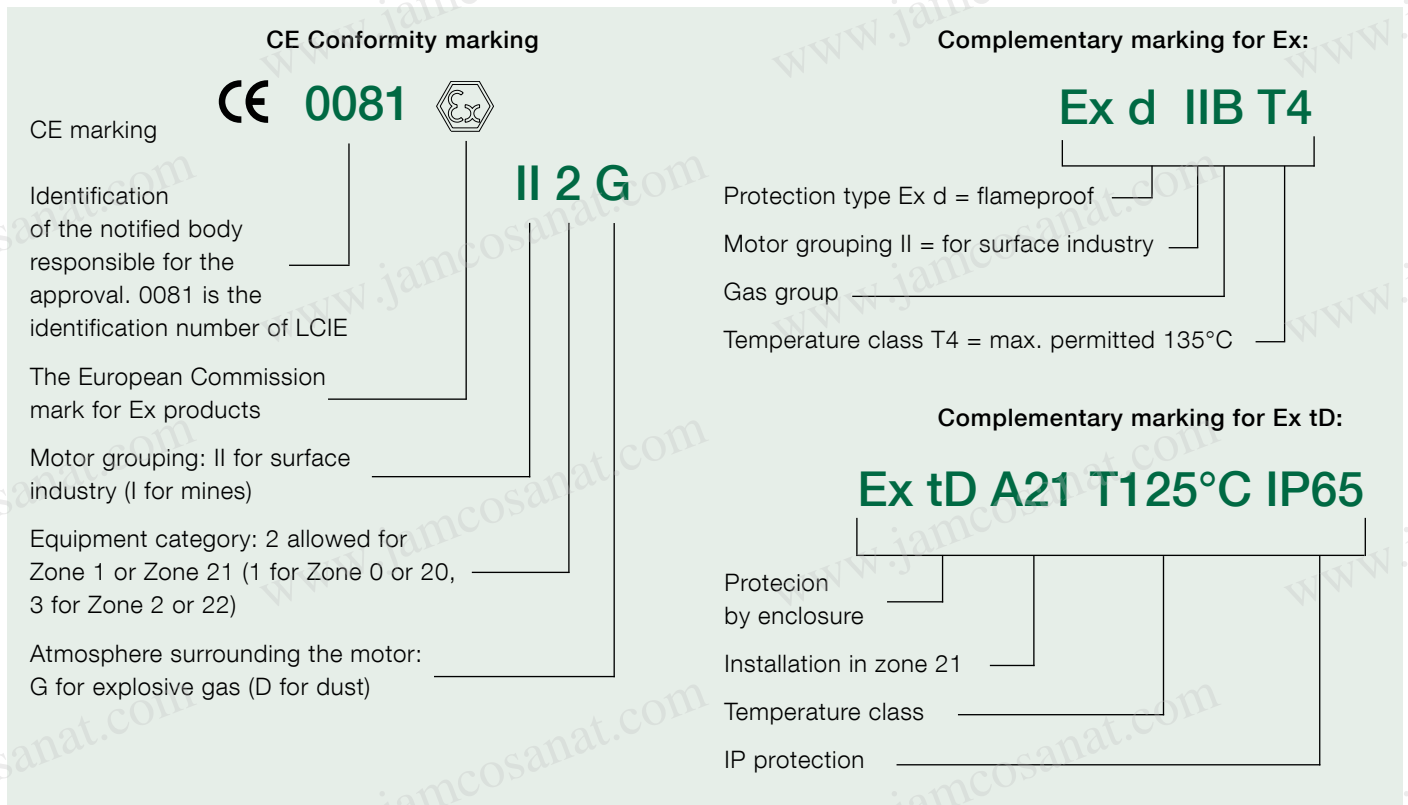

Marking of equipment according to IECEx

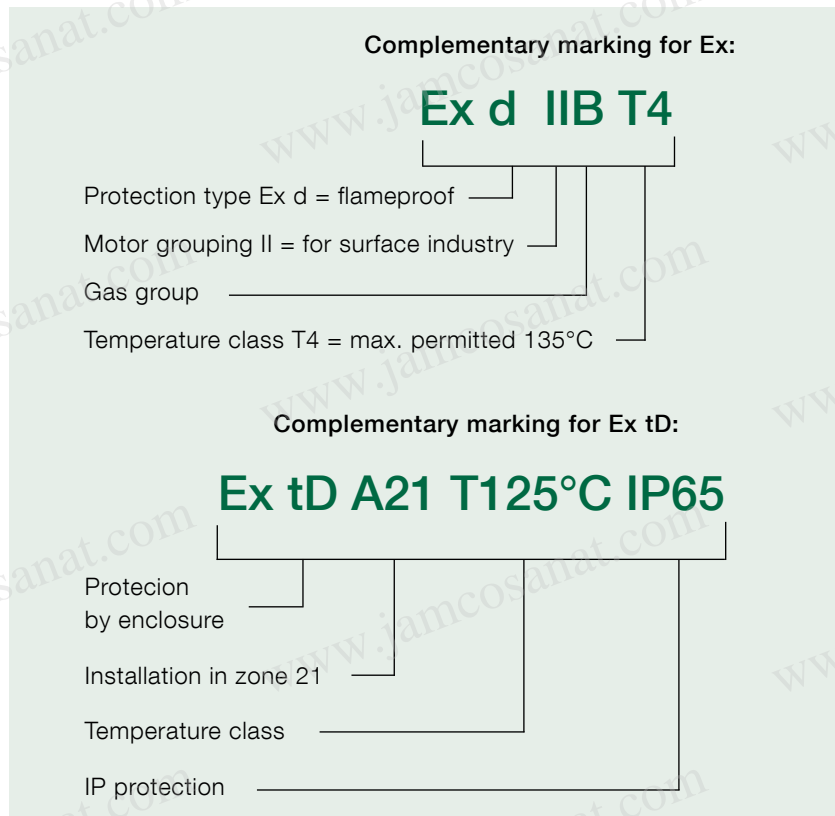

Selection of products for explosive atmospheres

EN Standard for Group II: Gas environments

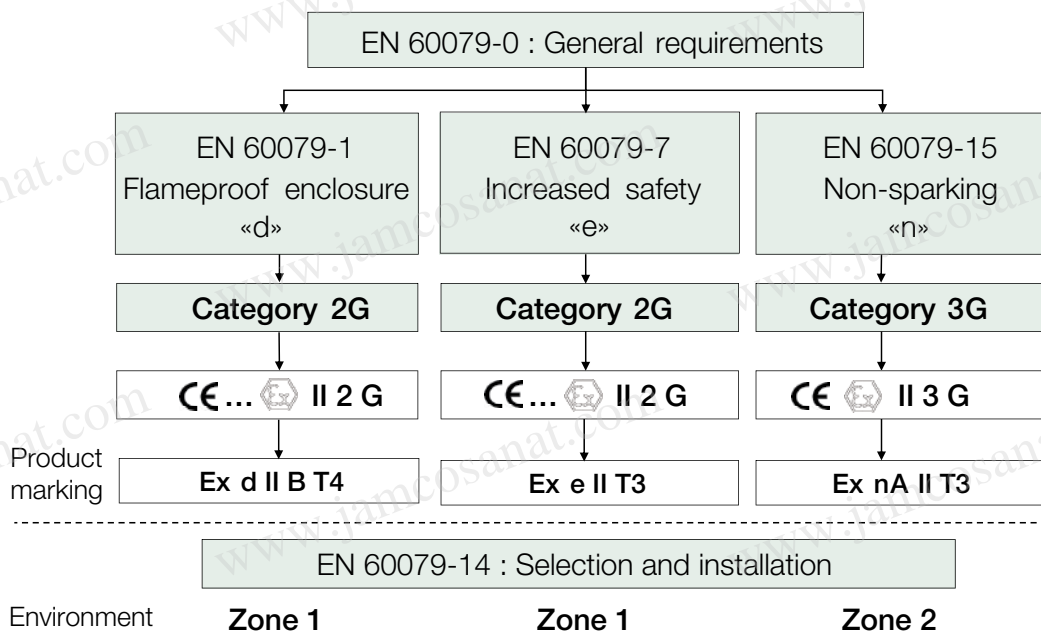

M000170

EN Standard for Group II: Dust environments

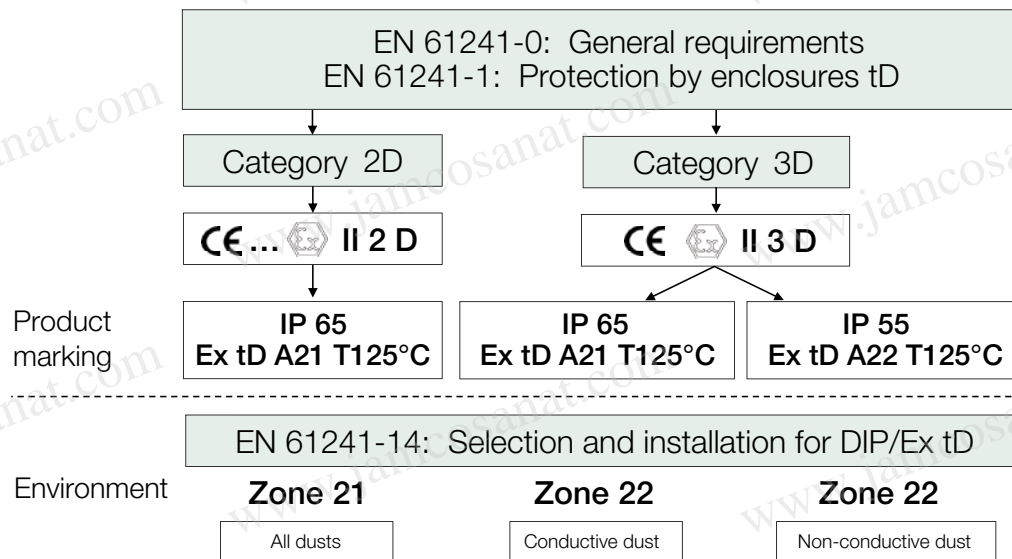

M000171

General about explosive atmospheres

Preamble

In explosive atmospheres, it is of the utmost importance to ensure the safe use of electrical apparatus. To this end, many countries have regulations concerning both the design and use of such apparatus. These regulations are becoming increasingly harmonized within the framework of IEC recommendations and European Standards. The hazard may be due to an explosive atmosphere composed of a mixture of gas, vapors or dusts with air. This chapter only deals with safety in explosive gas atmospheres for which European Standards exist.

Flameproof enclosure Ex d and Ex de

The motor enclosure shall be designed in such a way that no internal explosion can be transmitted to the explosive atmosphere surrounding the motor. The enclosure must withstand, without damage, any pressure levels caused by an internal explosion. The shape, length and gap of part assembly joints, at shaft opening, cable entries, etc., shall be designed to allow for throttling and cooling of hot gases escaping outside. The standards emphasize the impact of an explosive atmosphere (for instance, explosion pressure) over constructional requirements of such apparatus.

Work on assembly devices of enclosure component parts is only permitted using prescribed tools. Cable entries must meet the requirements of this type of protection.

The temperature of the motor's external enclosure shall not exceed the self-ignition temperature of the explosive atmosphere of the installation area during normal operation. For this reason, rated output depends on this rated maximum temperature for the considered area.

No motor device outside the flameproof enclosure (e.g., ventilation) shall be a potential source of sparks, arcs or dangerous overheating.

Variants combining two types of protection usually combine "d" and "e" protection. The motor is designed with an Ex d flameproof enclosure, while the terminal box features an Ex e increased safety protection. Such design combines the superior safety degree of the "d" type of protection with the less stringent electrical connection requirements of increased safety motors.

Motors featuring dual protection are seldom encountered—such as an increased safety motor with a flameproof enclosure designated Ex e / Ex d in European Standards.

Alleinschutz – thermistors as sole protection (optional)

The flameproof motors from ABB, frame sizes 80 to 400, have been certified for thermistors as sole protection against overload. This construction, "Alleinschutz", is available as an option, see variant codes.

"Alleinschutz" is a term that defines the certification of flameproof motor and protection device together. The certificate confirms that thermistors and relays will switch off the motor in case of overheating before the temperature of the motor's external enclosure exceeds the temperature marking stamped on the rating plate.

Each motor ordered with thermistors as sole protection will be tested, with locked rotor, up to the point where the thermistors trigger the relay to turn off the motor. At the triggering temperature, the motor has to be within the certified temperature class.

The relay is included in the certificate, which means that only approved relays can be used for "Alleinschutz".

Please note that sizes 315 to 400 require special technical solutions, consult ABB.

Increased safety design, Ex e

The design of this motor type prevents the occurrence of sparks, arcs or hot spots in service (including starting and locked rotor situation), that could reach the self-ignition temperature of the surrounding, potentially explosive atmosphere, in all inner and outer parts of the machine.

This is ensured by applying constructional or dimensional provisions that mainly concern:

- specified minimum values for creepage distances and clearances
- use of tracking-proof isolating materials
- suppression of sharp angles where static electrical loads could build-up
- ensuring electrical and mechanical assemblies are tightly secured
- minimum backlash values between stationary and rotating parts (e.g., air gap, ventilation, etc.)
- temperature-rise limits, taking into account locked rotor, normal operation, accidental mechanical stalling of machine under the most adverse thermal conditions, i.e. when thermal equilibrium of machine is reached while in service.

Temperature rise limits are to be considered for two operating aspects; one for normal operating conditions and the other under accidental stalling conditions.

Temperature rise limits under normal operating conditions

The expected electrical lifespan of a motor depends on its temperature rise for a given insulation class, and on the motor winding temperature, in operation, which is not homogeneous with hot spots appearing. For these reasons, a safety margin of 10 K is allowed for between windings temperature rise at rated output, as measured by the change of resistance method, and the maximum temperature rise permitted by the winding insulation class.

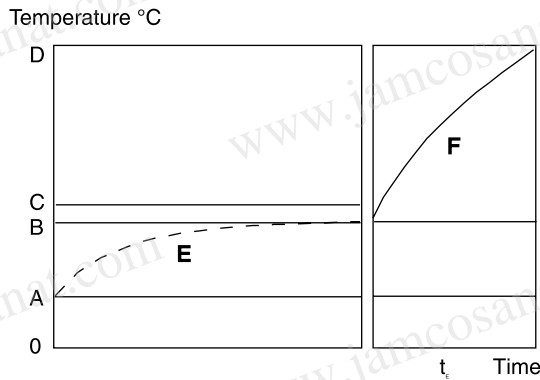

Figure 1.

- O = temperature 0°C
- A = Max. ambient temperature, reference 40°C
- B = Temperature at rated load and at worst voltage conditions
- C = Max temperature as permitted by the insul. class
- D = Max limit temperature as set by the nature of the potentially explosive atmosphere
- E = Temperature-rise curve of motor at rated output and at worst voltage conditions
- F = Temp. rise curve under stalled rotor conditions
- t_E = stalled rotor time

Temperature rise limits during short circuit under accidental stalling conditions

Should the machine stall while in operation, a shortcircuit current nearly equal to the starting current will develop, and stator and rotor winding temperatures will rise rapidly (see figure 1).

To prevent this temperature value from exceeding the temperature level below protection devices must trip within a specified time (t_E). This tripping time depends on the short-circuit current level or the short-circuit current to rated current ratio (I_A/I_N). Figures 2 and 3 show, for commonly used protection devices, the limiting ratio between short-circuit current inrush I_A/I_N and rotor stalling time t_E , according to the EN and VIK.

This type of protection is inappropriate for commutator machines or brake-motors which, by principle, are capable of producing arcs, sparks or hot spots.

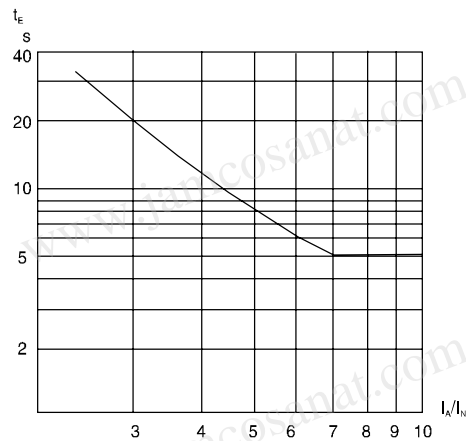

Figure 2. Min. value of time t_E as a function of I_A/I_N acc. to EN 50019.

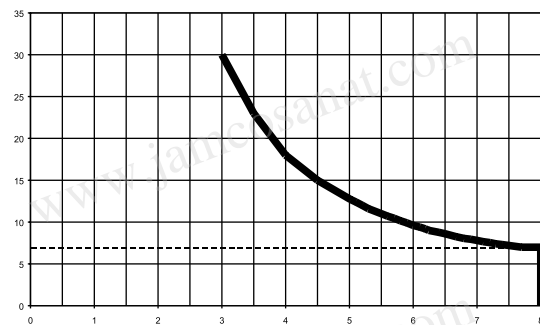

Figure 3. Min. value of time t_E as a function of I_A/I_N acc. to VIK.

Non-sparking design, Ex nA

This type of protection is allowed to be used in the hazardous area corresponding to zone 2. This design is also known as 'Non-sparking' type as the motor must be designed in such a way that no sparks can occur in any conditions, used within the ratings specified by the manufacturer, and that no excessive temperatures occur at normal conditions, which excludes thermal requirements due to starting or accidental stalling.

Ex nA motors are certified according to the ATEX 95 directive with a "voluntary type examination certificate".

ABB provides also non-sparking motors certified according to IEC Ex.

Dual certification

Ex nA motors in cast iron frame can also be used for Dust/Ex tD –applications in zone 22. Following combinations are possible:

- DIP T125°C/Ex tD A22, IP55 for zone 22 + Ex nA II T3
- DIP T125°C/Ex tD A22, IP65 for zone 22 + Ex nA II T3

These features are possible due to the IP protection. The gases penetrate this protection, and thus the inside surface temperature class is T3 (200°C). The ingress of dust, however, is prevented and the dust determines the outside surface temperature class: T 125°C.

Dust ignition protection / Protection by enclosures “tD” in explosive atmospheres

Combustible dusts are hazardous as they can form potentially explosive atmospheres when dispersed in the air. Furthermore, layers of combustible dust may ignite and act as an ignition source for an explosive atmosphere. Explosive atmospheres with dust can be found in a variety of industries such as agriculture, chemicals, plastics, stock holding.

Selection and installation of electrical equipment

To ensure equipment can be safely used in explosive atmospheres with dust, the following procedure should be considered before selecting a product:

1. Type of dust:

- Will a cloud of dust be present around the product or
- will a layer of dust build up on the product and if so, what will be the maximum thickness of the layer between two cleaning/maintenance periods?

2. Characteristics of the dust:

- Is the dust electrically conductive or non-conductive?

3. Ignition temperature of the dust:

- T_{Ci} : Ignition temperature of dust in a "cloud" or
- T_{5mm} : Ignition temperature of a 5 mm dust layer

This protection prevents any explosion transmission of dust because:

- The ingress of dust into the motor is prevented by the IP protection, being either IP55, called dust protected, or IP 65, called dust tight.
- The maximum surface temperature outside the motor must not exceed the temperature class for which the motor is certified.
- No sparks must occur outside the motor enclosure.

Certification: Ex tD A21 (for zone 21) motors are certified according to ATEX with an EC type examination certificate, whereas Ex tD A22 (for zone 22) motors have a “voluntary type examination certificate”.

Selection and installation of product: EN 61241-14

Equipment category	Category 1 (zone 20)	Category 2 (zone 21)	Category 3 (zone 22)
Minimum protection for equipment	Not applicable for electric motors	Ex tD/IP 6X	Ex tD A22/IP 5X for non-conductive dust Ex tD A22/IP 6X for conductive dust

Marking temperature

Type of dust	Ignition temperature of the dust	Maximum surface temperature of motor	Marking temperature of equipment T°C
Cloud	T_{CI}	$2/3 \times T_{CI}$	$T^{\circ}C \leq 2/3 \times T_{CI}$
Layer up to 5 mm	T_{5mm}	$T_{5mm} - 75 K$	$T^{\circ}C \leq (T_{5mm} - 75 K)$ or $T^{\circ}C \leq (2/3 \times T_{CI})$ Which ever value is the smallest value

Substances

Products	AIT for a cloud (°C)	AIT for a layer (°C)
PVC	450	330
Sulfur	240	250
Charcoal	520	230
Barley/Corn/Maize	380	280
Sugar	310	420
Wheat	350	270

Source BIA-report 13/97/HVVG

AIT = auto ignition temperature

Testing and certificates

Motors for explosive atmospheres have to be officially approved by a recognized test organization, authorized to issue test certificates, to ensure compliance with standards for this type of equipment.

Motors are defined and classified according to the categories and protection type which are defined in the corresponding standards.

Depending on the nature of the atmosphere, it is the responsibility of the user to determine which group and which maximum surface temperature should be specified for the motor installation.

The motors are rated and certified for ambient temperature between -20°C and $+40^{\circ}\text{C}$ according to standards. For ambient temperatures below -20°C and above $+40^{\circ}\text{C}$ certificates are available for most of the motors.

Risk assessment and gas tests

Non-sparking (Ex nA) and increased safety (Ex e) motors have to meet tough requirements with regard to sparking. The latest IEC and EN standards specify criteria for risk assessment and gas environment tests for rotor and stator designs to show that the motors are spark-free in all operational conditions.

By testing and securing certification for its motors, ABB is helping to streamline the risk assessment process for its customers.

The alternative to testing and certification involves, in the majority of cases, equipping the motor with provision for pre-start ventilation. This means investing in a higher capacity air compressor, piping, and a ventilation control unit. It also requires an additional operation – ventilation – every time the motor is started.

ABB's motors conform to the stringent standards set by CENELEC (European Committee for Electrotechnical Standardization), and are approved by testing laboratories (ExNB: Notified Body).

Motors can be certified by any of the Notified Bodies "ExNB" of EU member countries. These motors are therefore acceptable in all EU countries and many other countries.

Global certificates available are: IECEx System, ATEX and CSA certificates. Typical national certificates available are e.g. GOST-R for Russia, GOST-K for Kazakhstan, INMETRO for Brazil and CQST for China. KOSHA certification for Korea is available, but has to be applied for case by case. Local certifications are mainly obtained based on IECEx or ATEX.

Benefits of the ABB approach therefore include reduced initial capital expenditure, lower operating costs, and faster starting. Reliability is improved as no additional components are required. Most importantly, ABB's certified motors offer proven safety, as testing represents the only way to verify that equipment is really safe.

ABB's approach to meet the new requirements

Following a program of gas environment tests in which all rotor and stator tests were passed, ABB has secured certification for its low voltage cast iron motors for explosive atmospheres with aluminum die cast rotor.

International motor efficiency standards

Since the validation of the standard IEC/EN 60034-30, a worldwide energy efficiency classification system exists for low voltage three-phase asynchronous motors. This system increases the level of harmonization in efficiency regulations around the world and it also covers Hazardous area motors. International Electrotechnical Commission (IEC) standard IEC/EN 60034-30:2008 defines energy-efficiency (IE code) classes for single speed, three-phase, 50 and 60 Hz induction motors. The standard is part of an effort to unify motor testing procedures and efficiency and product labeling requirements to enable motor purchasers worldwide to easily recognize premium efficiency products. The efficiency levels defined in IEC/EN 60034-30 are based on test methods specified in IEC/EN 60034-2-1:2007.

To promote transparency in the market, IEC 60034-30 states that both the efficiency class and efficiency value must be shown on the motor rating plate and in product documentation. The documentation must clearly indicate the efficiency testing method used as the different methods can produce differing results.

Motors for explosive atmospheres being part of the scope of this standard IEC/EN 60034-30 means that Ex-motors can be labeled with IE-code. Ex-motors are already included in many other MEPS (Minimum Energy Performance Standard) schemes around the world; Australia, US, Canada, China, Korea, Brazil.

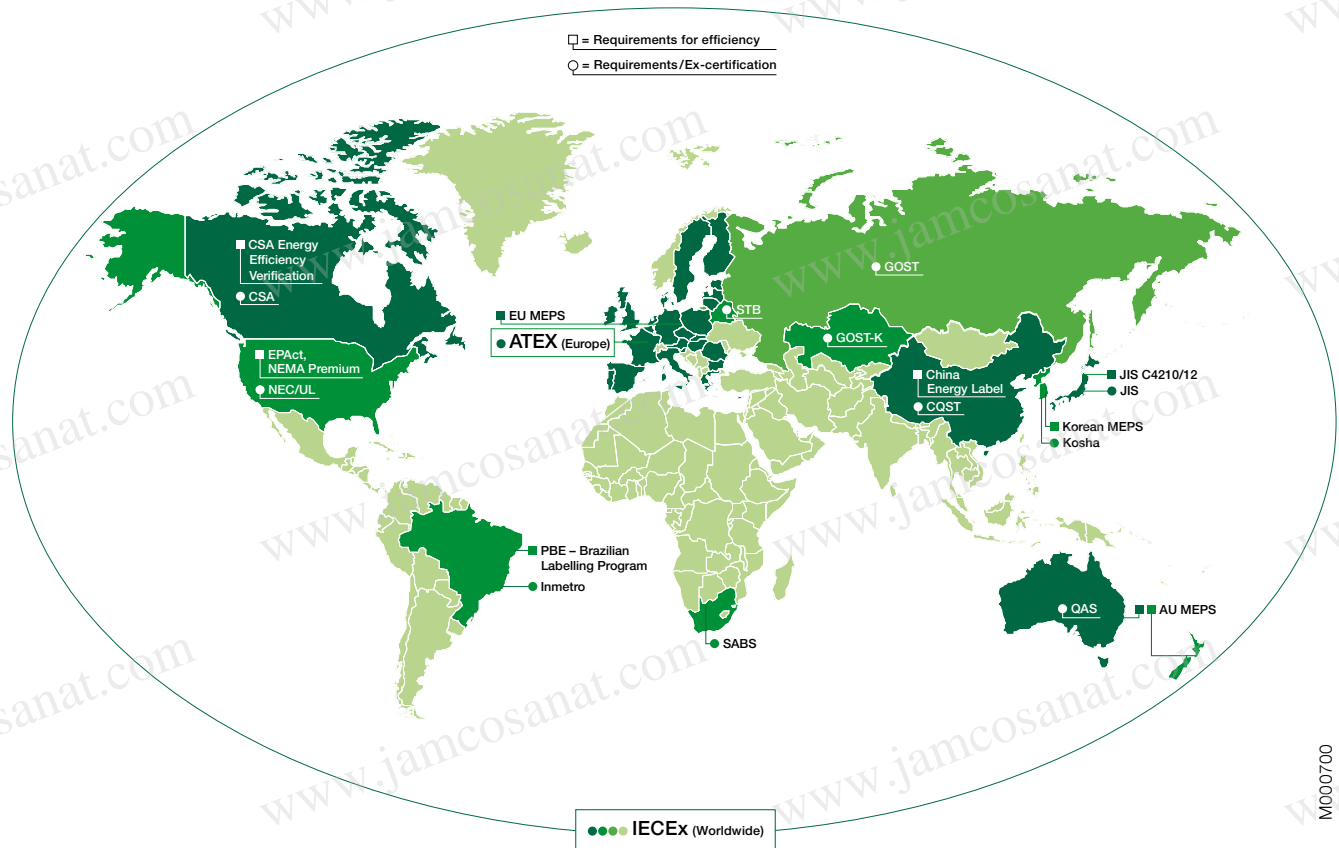

IEC/EN 60034-30:2008

IEC/EN 60034-30:2008 defines three International Efficiency (IE) classes for single speed, three-phase, cage induction motors.

- IE1 = Standard efficiency (EFF2 in the former European classification scheme)
- IE2 = High efficiency (EFF1 in the former European classification scheme and identical to EPAct in the USA for 60 Hz)
- IE3 = Premium efficiency (identical to "NEMA Premium" in the USA for 60 Hz)
- IE4 = Super premium, according to IEC/TS 60034-31

Efficiency levels defined in IEC/EN 60034-30 are based on test methods specified in IEC/EN 60034-2-1:2007.

Compared to the former European efficiency classes defined by the CEMEP agreement the scope has been expanded.

IEC/EN 60034-30 covers almost all motors (for example standard, hazardous area, marine, brake motors)

- Single speed, three-phase, 50 Hz and 60 Hz
- 2-, 4- or 6-pole
- Rated output from 0.75 to 375 kW
- Rated voltage U_N up to 1000 V
- Duty type S1 (continuous duty) or S3 (intermittent periodic duty) with a rated cyclic duration factor of 80 % or higher
- Capable of operating direct online

The following motors are excluded from IEC 60034-30:

- Motors made solely for converter operation
- Motors completely integrated into a machine (for example, pump, fan or compressor) that cannot be tested separately from the machine

Minimum efficiency values defined in IEC 60034-30:2008 standard (based on test methods specified in IEC 60034-2-1:2007)

Output kw	IE1			IE2			IE3		
	Standard efficiency			High efficiency			Premium efficiency		
	2 pole	4 pole	6 pole	2 pole	4 pole	6 pole	2 pole	4 pole	6 pole
0.75	72.1	72.1	70.0	77.4	79.6	75.9	80.7	82.5	78.9
1.1	75.0	75.0	72.9	79.6	81.4	78.1	82.7	84.1	81.0
1.5	77.2	77.2	75.2	81.3	82.8	79.8	84.2	85.3	82.5
2.2	79.7	79.7	77.7	83.2	84.3	81.8	85.9	86.7	84.3
3	81.5	81.5	79.7	84.6	85.5	83.3	87.1	87.7	85.6
4	83.1	83.1	81.4	85.8	86.6	84.6	88.1	88.6	86.8
5.5	84.7	84.7	83.1	87.0	87.7	86.0	89.2	89.6	88.0
7.5	86.0	86.0	84.7	88.1	88.7	87.2	90.1	90.4	89.1
11	87.6	87.6	86.4	89.4	89.8	88.7	91.2	91.4	90.3
15	88.7	88.7	87.7	90.3	90.6	89.7	91.9	92.1	91.2
18.5	89.3	89.3	88.6	90.9	91.2	90.4	92.4	92.6	91.7
22	89.9	89.9	89.2	91.3	91.6	90.9	92.7	93.0	92.2
30	90.7	90.7	90.2	92.0	92.3	91.7	93.3	93.6	92.9
37	91.2	91.2	90.8	92.5	92.7	92.2	93.7	93.9	93.3
45	91.7	91.7	91.4	92.9	93.1	92.7	94.0	94.2	93.7
55	92.1	92.1	91.9	93.2	93.5	93.1	94.3	94.6	94.1
75	92.7	92.7	92.6	93.8	94.0	93.7	94.7	95.0	94.6
90	93.0	93.0	92.9	94.1	94.2	94.0	95.0	95.2	94.9
110	93.3	93.3	93.3	94.3	94.5	94.3	95.2	95.4	95.1
132	93.5	93.5	93.5	94.6	94.7	94.6	95.4	95.6	95.4
160	93.7	93.8	93.8	94.8	94.9	94.8	95.6	95.8	95.6
200	94.0	94.0	94.0	95.0	95.1	95.0	95.8	96.0	95.8
250	94.0	94.0	94.0	95.0	95.1	95.0	95.8	96.0	95.8
315	94.0	94.0	94.0	95.0	95.1	95.0	95.8	96.0	95.8
355	94.0	94.0	94.0	95.0	95.1	95.0	95.8	96.0	95.8
375	94.0	94.0	94.0	95.0	95.1	95.0	95.8	96.0	95.8

ABB and efficiency standards





































As a global player committed to supplying safe, reliable and efficient motors, ABB designs and labels its motors for explosive atmospheres to comply with international efficiency standards published by the IEC (International Electrotechnical Commission). ABB determines efficiency values according to IEC/EN 60034-2-1 using the low uncertainty method i.e. indirect method, with additional load losses determined by measurement.

As the world market leader, ABB offers the largest range of LV motors available. It has long advocated the need for efficiency in motors, and high efficiency products have formed the core of its portfolio for many years. The core of ABB's Ex range is based on a full range of IE2 motors – with many available from stock. At the end of 2010 ABB launches the first of its future range of Premium efficiency motors for explosive atmospheres.

Low voltage general technical specification

Mechanical and electrical design

Mounting arrangements

	Codel/Codell						Product code pos. 12
Foot-mounted motor.	IM B3 IM 1001	IM V5 IM 1011	IM V6 IM 1031	IM B6 IM 1051	IM B7 IM 1061	IM B8 IM 1071	A = foot-mounted, term.box top R = foot-mounted, term.box RHS L = foot-mounted, term.box LHS
							M000007
Flange-mounted motor, large flange	IM B5 IM 3001	IM V1 IM 3011	IM V3 IM 3031	*) IM 3051	*) IM 3061	*) IM 3071	B = flange mounted, large flange
							M000008
Flange-mounted motor, small flange	IM B14 IM 3601	IM V18 IM 3611	IM V19 IM 3631	*) IM 3651	*) IM 3661	*) IM 3671	C = flange mounted, small flange
							M000009
Foot- and flange-mounted motor with feet, large flange	IM B35 IM 2001	IM V15 IM 2011	IM V36 IM 2031	*) IM 2051	*) IM 2061	*) IM 2071	H = foot/flange-mounted, term.box top S = foot/flange-mounted, term.box RHS T = foot/flange-mounted, term.box LHS
							M000010
Foot- and flange-mounted motor with feet, small flange	IM B34 IM 2101	IM V17 IM 2111	IM 2131	IM 2151	IM 2161	IM 2171	J = foot/flange-mounted, small flange
							M000011
Foot-mounted motor, shaft with free extensions	IM 1002	IM 1012	IM 1032	IM 1052	IM 1062	IM 1072	
							M000012

*) Not stated in IEC 60034-7.

Note: In case of motors mounted with the shaft upwards and water or liquid are expected to go down along the shaft, the user must take into account to mount some means capable to preventing it.

Voltage and frequency

The table values for output, speed, efficiency, power factor, starting torque and starting current apply at the rated voltage and frequency. These values will be affected if the supply voltage or frequency deviate from the rated values.

The motors can operate continuously at the rated output, with a long-term voltage deviation of 5 % from the specified value or range of values, and at the rated frequency without exceeding the temperature class stamped on the rating plate. The temperature rise of the winding may increase by 10 K, but without exceeding the insulation temperature class stamped on the rating plate. Voltage deviations of up to 10 % are permissible for short periods only.

Surface treatment

ABB cast iron motors for explosive atmospheres are provided as standard with a painting system that corresponds to corrosion category C3M specified by ISO/EN 12944:2. ISO/EN 12944 divides durability into 3 ranges: low (L), medium (M) and high (H). Low (L) durability corresponds to 2-5 years, medium (M) to 5-15 years and high (H) to more than 15 years. ABB surface treatment corresponds to medium (M) durability.

Durability does not represent a guaranteed time span. Instead it is a technical consideration that can help the owner to set up a maintenance program. Maintenance is

often required at more frequent intervals because of fading, chalking, combination or wear and tear or for other reasons.

Other corrosion categories (C4M and C5M) are available as options. In addition surface treatment according to Norsok requirements (755) for offshore environments is available as an option. Please see the variant code section for exact availability.

Standard ABB colour is Munsell Blue 8B 4.5/3.25. Other colours are available and can be ordered with variant code 114.

Classification of atmospheric environments according to ISO 12944:2 based on thickness loss.

Corrosivity categories	Outdoor atmospheres	Indoor atmospheres	ABB
C1 - Very low	-	Heated buildings with clean atmospheres, e.g. offices, shops, schools, hotels.	
C2	Atmospheres with low level of pollution. Mostly rural areas.	Unheated buildings where condensation may occur e.g. depots, sport halls	
C3 - Medium	Urban and industrial atmospheres, moderate sulfur dioxide pollution. Coastal areas with low salinity.	Production rooms with high humidity and some air pollution e.g. food-processing plants, laundries, breweries, dairies	Standard surface treatment
C4- High	Industrial areas and coastal areas with moderate salinity.	Chemical plants, swimming pools, coastal ship- and boatyards.	Optional surface treatment with variant code 115
C5-I - Very high	Industrial areas with high humidity and aggressive atmosphere.	Buildings or areas with almost permanent condensation and with high pollution.	
C5-M - Very high	Coastal and offshore areas with high salinity.	Buildings or areas with almost permanent condensation and with high pollution.	Optional surface treatment with variant code 754

Bearings

ABB policy is to have reliability as a vital issue in bearing design as well as in bearing lubrication systems. That is why we, as standard, follow the L_1 -principle for calculating regreasing intervals (meaning that 99 per cent of the bearings achieve or exceed the calculated grease lifetime). The lubrication intervals can also be calculated according to L_{10} -principle which means that 90 per cent of the motors are sure to make the interval time. L_{10} -values, which are normally doubled compare to L_1 -values, are available from ABB at request.

Motors with permanently greased bearings

Cast iron motors up to frame size 132 and aluminum motors up to frame size 250 are normally fitted with permanently greased bearings of type Z or 2Z. The exception is 2D DIP motors with aluminum frame sizes 63-132, which are fitted with 2RS bearings because higher protection is required.

Lubrication

Lubricate the motor when operational. If a grease outlet plug is fitted, temporarily remove when lubricating, or permanently with auto lubrication. If the motor is fitted with a lubrication plate, use values given, or use the values given in the table beside. These values are according to L_1 -principle, which is the ABB standard for all motors.

The effectiveness of the motor lubrication should be checked by measuring the surface temperature of bearing endshields during normal operating conditions. If the measured temperature is $+80^{\circ}\text{C}$ or above, the relubrication intervals

Guidelines for bearing life time acc. to L_1 principle:

Aluminum motors

- 2 and 2/4 pole motors, 10 000 - 20 000 duty hours ¹⁾
- 4 to 8 pole motors, 20 000 - 40 000 duty hours ¹⁾

Cast iron motors

- 2 and 2/4 pole motors, 20 000 duty hours ¹⁾
- 4 to 8 pole motors, 40 000 duty hours ¹⁾

¹⁾ depending on application and load conditions.

Motors fitted with grease nipples

Cast iron motors from frame size 160 are as standard fitted with regreasable bearings.

Lubricate the motor when operating.

For motors with lubrication systems we recommend not to exceed lubrication interval of two years in any case.

must be shortened; i.e. the relubrication interval should be halved for every 15K increase in bearing temperature. If this is not possible ABB recommends the use of lubricants suitable for high operating temperature conditions. These lubricants allow a normal relubrication interval and 15K increase in bearing temperature conditions.

Formula to change the L_1 values roughly to L_{10} values:

$$L_{10} = 2.0 \times L_1$$

Lubrication intervals according to L₁ principle

Frame size	Amount of grease g/bearing	kW	3600	3000	kW	1800	1500	kW	1000	kW	500-900
			r/min	r/min		r/min	r/min		r/min		r/min
Ball bearings											
Lubrication intervals in duty hours											
112	10	all	10000	13000	all	18000	21000	all	25000	all	28000
132	15	all	9000	11000	all	17000	19000	all	23000	all	26500
160	25	≤ 18,5	9000	12000	≤ 15	18000	21500	≤ 11	24000	all	24000
160	25	> 18,5	7500	10000	> 15	15000	18000	> 11	22500	all	24000
180	30	≤ 22	7000	9000	≤ 22	15500	18500	≤ 15	24000	all	24000
180	30	> 22	6000	8500	> 22	14000	17000	> 15	21000	all	24000
200	40	≤ 37	5500	8000	≤ 30	14500	17500	≤ 22	23000	all	24000
200	40	> 37	3000	5500	> 30	10000	12000	> 22	16000	all	20000
225	50	≤ 45	4000	6500	≤ 45	13000	16500	≤ 30	22000	all	24000
225	50	> 45	1500	2500	> 45	5000	6000	> 30	8000	all	10000
250	60	≤ 55	2500	4000	≤ 55	9000	11500	≤ 37	15000	all	18000
250	60	> 55	1000	1500	> 55	3500	4500	> 37	6000	all	7000
280 ¹⁾	60	all	2000	3500	-	-	-	-	-	-	-
280 ¹⁾	60	-	-	-	all	8000	10500	all	14000	all	17000
280	35	all	1900	3200	-	-	-	-	-	-	-
280	40	-	-	-	all	7800	9600	all	13900	all	15000
315	35	all	1900	3200	-	-	-	-	-	-	-
315	55	-	-	-	all	5900	7600	all	11800	all	12900
355	35	all	1900	3200	-	-	-	-	-	-	-
355	70	-	-	-	all	4000	5600	all	9600	all	10700
400	40	all	1500	2700	-	-	-	-	-	-	-
400	85	-	-	-	all	3200	4700	all	8600	all	9700
450	40	all	1500	2700	-	-	-	-	-	-	-
450	95	-	-	-	all	2500	3900	all	7700	all	8700
Roller bearings											
Lubrication intervals in duty hours											
160	25	≤ 18,5	4500	6000	≤ 15	9000	10500	≤ 11	12000	all	12000
160	25	> 18,5	3500	5000	> 15	7500	9000	> 11	11000	all	12000
180	30	≤ 22	3500	4500	≤ 22	7500	9000	≤ 15	12000	all	12000
180	30	> 22	3000	4000	> 22	7000	8500	> 15	10500	all	12000
200	40	≤ 37	2750	4000	≤ 30	7000	8500	≤ 22	11500	all	12000
200	40	> 37	1500	2500	> 30	5000	6000	> 22	8000	all	10000
225	50	≤ 45	2000	3000	≤ 45	6500	8000	≤ 30	11000	all	12000
225	50	> 45	750	1250	> 45	2500	3000	> 30	4000	all	5000
250	60	≤ 55	1000	2000	≤ 55	4500	5500	≤ 37	7500	all	9000
250	60	> 55	500	750	> 55	1500	2000	> 37	3000	all	3500
280 ¹⁾	60	all	1000	1750	-	-	-	-	-	-	-
280 ¹⁾	70	-	-	-	all	4000	5250	all	7000	all	8500
280	35	all	900	1600	-	-	-	-	-	-	-
280	40	-	-	-	all	4000	5300	all	7000	all	8500
315	35	all	900	1600	-	-	-	-	-	-	-
315	55	-	-	-	all	2900	3800	all	5900	all	6500
355	35	all	900	1600	-	-	-	-	-	-	-
355	70	-	-	-	all	2000	2800	all	4800	all	5400
400	40	all	-	1300	-	-	-	-	-	-	-
400	85	-	-	-	all	1600	2400	all	4300	all	4800
450	40	all	-	1300	-	-	-	-	-	-	-
450	95	-	-	-	all	1300	2000	all	3800	all	4400

Transport locking

Motors with roller bearings or an angular contact ball bearing are fitted with a transport lock before despatch to prevent damage to the bearings during transport. When the transport lock is fitted, the motor is provided with a warning sign.

Locking may also be fitted in other cases where the transport handling could be damaging.

Axially-locked bearings

The table below shows axial locking of the bearings. See also variant code 042.

Aluminum motors

Motor size	Foot-mounted motors	Flange-mounted motors	
		Large flange	Small flange
63	On request at D-end	On request at D-end	
63-132	D-end ¹⁾	D-end ¹⁾	D-end ¹⁾
160-280	D-end	D-end	-

¹⁾ A spring washer at the N-end locates the rotor at the D-end.

Cast iron motors

Motor size	Foot-mounted motors	Flange-mounted motors
80-450	D-end	D-end
Flameproof motors:		
80-400	D-end	D-end

Axial and radial forces

Please see separate sections. Detailed information about permissible loadings on the shaft end can be found under each motor protection type.

Low voltage motors and frequency converters for explosive atmospheres

Frequency converters provide significant benefits when used with motors for explosive atmospheres. The advantages include better process control through regulation of the motor speed, as well as energy savings, and therefore improved environmental performance.

Certain criteria must be taken into account to ensure the safety of the frequency converter and motor combination, as well as the maximum usability of the application. The requirements depend on the protection type in use and whether the motor is regarded as being one component within a wider system or a separate subsystem.

ABB offers hazardous area motors for use with variable speed drives with the following protection types: flameproof, increased safety (on request), non-sparking, and dust ignition proof. These motors are designed and certified for operation with frequency converters. Instructions for the different protection types, as well as for the most common types of converter, are provided below. If further information is needed, please do not hesitate to contact ABB.

A. Main requirements for hazardous area motors used with variable speed drives

1. Flameproof motors (Ex d, Ex de)

The standards specify that the motor must be dimensioned so that its maximum outer surface temperature is limited according to the temperature class. In most cases this requires either type tests or control of the outer surface temperature of the motor.

Most ABB flameproof motors for temperature class T4 have been type tested with ABB ACS800 converters utilizing Direct Torque Control (DTC) as well as with ABB ACS550 frequency converters, and these combinations can be selected using the loadability curves shown in Figures 2 and 4. Combined tests with above mentioned converters are needed only if the limits of the loadability curves are exceeded. On such cases also separate certification of the motor and converter combination may be required.

In the case of other voltage source converters using pulse width modulation (PWM) with scalar or vector control, combined tests are needed to confirm the correct thermal performance of the motor. These tests can be avoided if the motor is fitted with thermal sensors to control the surface temperature. Such motors have the following additional markings on their rating plate: -"PTC" with the tripping temperature and "DIN 44081/82"

In the case of voltage source PWM converters, with a minimum switching frequency of 3 kHz or higher, the instructions provided in section B/2.4 can be used for preliminary dimensioning.

For more information on using flameproof motors for temperature classes T5 and T6 with variable speed drives, please contact ABB.

2. Increased safety motors (Ex e)

The motor should always be tested together with the specified converter, and ABB therefore does not recommend the use of low voltage increased safety motors with variable speed drives.

3. Non-sparking motors (Ex nA)

According to the standards, the combination of motor and converter must be tested as a unit with the specified converter or a comparable one or dimensioned by calculation.

ABB non-sparking cast iron motors have been type tested with ABB ACS800 converters utilizing DTC control) as well as with ABB ACS550 converters, and these combinations can be selected using the dimensioning instructions provided in section B/2.2. Combined tests with above mentioned ACS800 and ACS550 converters are needed only if the limits of the loadability curves are exceeded. On such cases also separate certification of the motor and converter combination may be required.

In the case of other voltage source PWM converters, combined tests are needed to confirm the correct thermal behavior of the motor. For preliminary dimensioning purposes, the instructions provided in section B/2.4 can be used. The final values must be verified by combined tests.

4. Dust ignition proof motors (Ex tD)

The standards specify that the motor must be dimensioned so that its maximum outer surface temperature is limited according to the temperature class (e.g. T125°C or T150°C). For more information on temperature classes lower than 125°C, please contact ABB.

ABB Ex tD motors (T125°C and T150°C) have been type tested with ACS800 converters utilizing DTC control as well as with ABB ACS550 converters, and these combinations can be selected using the dimensioning instructions provided in section B/2.4. Combined tests with above mentioned ACS800 and ACS550 converters are needed only if the limits of the loadability curves are exceeded. On such cases also separate certification of the motor and converter combination may be required.

In the case of any other voltage source PWM converter, combined tests are needed to confirm the correct thermal performance of the motor. These tests can be avoided if the motor is fitted with thermal sensors to control the surface temperature. Such motors have the following additional markings on their rating plate: -"PTC" with the tripping temperature and "DIN 44081/82".

In the case of voltage source PWM converters with a minimum switching frequency of 3 kHz or higher, the instructions provided in section B/2.2 can be used for preliminary dimensioning.

B. Other safety criteria

These criteria are imposed by the competent bodies in order to ensure the safe use of motors with converters in explosive atmospheres.

1. Type tests and certification

ABB has type tested and certified the complete range Exd, Ex de, Ex nA and Ex tD/DIP motors for operation with frequency converters. On request, ABB can supply type test reports based on the test procedure specified by the Notified Bodies for a representative number of motors with ACS800 and ACS550 converters.

For other voltage source PWM converters, in most cases a combined type test is required to ensure safe operation.

2. Motor dimensioning for variable speed applications

2.1 General

The voltage (or current) fed by the frequency converter is not purely sinusoidal. This may increase motor losses, vibration, and noise. Furthermore, a change in the distribution of the losses may affect the motor temperature balance and lead to increased temperature.

When the motor is operating at low speeds the cooling capacity of the ventilation fan is decreased, which reduces the motor's loadability. A separate constant speed fan can be used to increase cooling capacity and loadability at low speeds.

When dimensioning a motor for variable speed applications, the continuous thermal dimensioning and short time overloads should be considered.

2.2 Thermal dimensioning with ABB ACS800 converters utilizing DTC control

In the case of ABB ACS800 converters utilizing DTC control, dimensioning can be done using the loadability curves (or load capacity curves) in Figures 2 and 3. The loadability curves show the maximum allowed continuous output torque of the motor as a function of supply frequency. The output torque is given as a percentage of the motor's nominal torque.

The most convenient method to dimension the motor is to utilize ABB's DriveSize program. This tool can be downloaded from the ABB website (www.abb.com/motors&generators)

The loadability curves are based on nominal supply voltage.

Note: the maximum speed of the motor must not be exceeded even if the loadability curves extend to 100 Hz.

2.3 Thermal dimensioning with ABB ACS550 converters

In the case of ABB ACS550 converters, dimensioning can be done using the loadability curves in Figures 4 and 5. Also for

ACS550 driven applications, the most convenient method to dimension the motor is to utilize ABB's DriveSize program.

Note 1. The loadability curves in Figures 4 and 5 are based on 4 kHz switching frequency.

Note 2. For constant torque applications the lowest allowed continuous operating frequency is 15 Hz.

Note 3. For quadratic torque applications lowest continuous operating frequency is 5 Hz.

2.4 Thermal dimensioning with other voltage source PWM-type converters

For VSDs other than DTC-controlled ACS800 and ACS550 converters, preliminary dimensioning can be done using the loadability curves in Figures 4 and 5. The utilization of these curves assume a minimum switching frequency of 3 kHz.

To ensure safe operation, the combination must either be tested for the specific protection type or thermal sensors must be fitted to control the surface temperature. Frequencies below 15 Hz shall be avoided or tested separately.

Note: the actual thermal loadability of a motor may be lower than shown by the guideline curves.

2.5 Short time overloads

Short time overloading is usually possible with ABB flameproof motors. For the exact values, please see the motor's rating plate.

Overloadability is specified by three factors:

I_{OL} Maximum short time current

T_{OL} Length of allowed overload period

T_{COOL} Cooling time required after each overload period. During the cooling period the motor current and torque must remain below the limit of allowed continuous loadability.

3. Operating speed

When a motor is used with a frequency converter, its actual operating speed may deviate considerably from its nominal speed (i.e. the speed stamped on the rating plate). When operating at higher speeds, ensure that the highest permissible rotational speed of the motor, or the critical speed of the equipment as a whole, is not exceeded.

The permitted maximum speed must be stated on a rating plate. This can be either a separate plate or the regular plate required for variable speed drive motors.

4. Thermal protection of windings

Most ABB Ex motors are equipped with PTC thermistors to prevent the winding temperatures from exceeding the thermal limits of the insulation materials (usually Insulation Class F). Please check the product specific data in the corresponding section of this catalogue.

In countries where the ATEX requirements are in force, the thermistors must be connected to a thermistor circuit relay. The relay must function independently and reliably trip off the supply to the motor according to the requirements of the "Essential Health and Safety Requirements" in Annex II, item 1.5.1 of the ATEX Directive 94/9/EC.

In countries where the ATEX requirements are not in force, it is nevertheless recommended that the thermistors are connected to a thermistor circuit relay that functions independently and will reliably trip off the supply to the motor.

Note: local installation rules may also allow the thermistors to be connected to equipment other than a thermistor relay, such as the control inputs of a frequency converter.

Note: the above recommendations do not apply to increased safety 'e' motors.

5. Rating plates

The following parameters must be shown on the rating plates of hazardous area motors intended for variable speed operation:

- speed or frequency range
- power range

ABB Oy, Motors Vaasa, Finland		CE 0081 IE2		Ex II 2G		
3 ~ Motor		M3KP 225SMC 4 IMB3/IM1001				
Ex de IIB T4						
414141-43		2010		No. 3GF1000002		
		Ins.cl. F		IP 55		
V	Hz	kW	r/min	A	cos φ	Duty
690 Y	50	45	1477	45	0.88	S1
400 D	50	45	1477	78	0.88	S1
415 D	50	45	1479	77	0.86	S1
IE2 - 94.1% (100%) - 94.6% (75%) - 94.4% (50%)						
Prod. code 3GKP222230-ADG						
LCIE 00 ATEX 6029 / IECEx LCI 04.0005						
		Nmax		r/min		
6313/C3		6312/C3		405 kg		
ABB		IEC 60034-1				

M000732

CONVERTER SUPPLY					
VALID FOR 400-415 V FWP 50 Hz					
3 ~ Motor M3KP 225SMC 4 IMB3/IM1001					
3GF1000002					
MIN. SWITCHING FREQ. FOR PWM CONV. 3 kHz					
IOL= 1.5 x In tOL= 10 s tOOOL= 10 min					
Duty S9					
ACS800 with DTC-CONTROL					
f [Hz]	5	20	45	50	60
T/Tn [%]	75	88	100	90	75
ACS550					
f [Hz]	15	20	45	50	60
T/Tn [%]	80	83	95	85	70
PTC 155C DIN 44081/82					
ABB		IEC 60034-1			

M000733

- voltage range
- type of torque (constant or quadratic)
- converter type and required minimum switching frequency

These parameters shall be used while checking the suitability of a specific motor for its intended application and for setting the limits of operation for the converter.

C. Technical criteria

1. Lubrication

The effectiveness of the motor lubrication should be checked by measuring the surface temperature of the bearing endshields under normal operating conditions. For more information, see "Manual for hazardous area motors".

In continuous operation at very low speeds, as well as at low temperatures, the lubrication capabilities of standard greases may not be sufficient, making it necessary to use special greases with additives.

If the motor is equipped with sealed bearings (i.e. bearings greased for life) any deviation in the operating temperature from the design temperature will result in a change in the lifetime of the bearing.

2. Winding insulation

The output voltage of voltage source frequency converters consists of steep voltage pulses. These pulses can be even higher and steeper when arriving at the motor terminals due to reflecting pulses in the cables. The motor's insulation must therefore be selected according to the actual pulses at the motor terminals.

2.1 Phase to phase voltages

The maximum allowed phase to phase voltage peaks at the motor terminals as a function of pulse rise time can be seen in Figure 1.

Figure 1. Allowed phase to phase voltage peaks at motor terminals as a function of rise time.

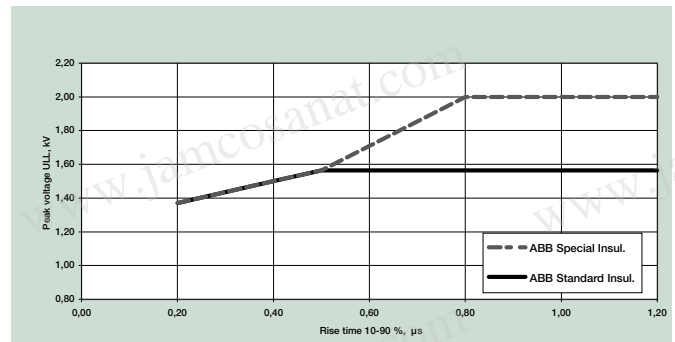

M000408

The highest curve ("ABB Special Insulation") applies to random wound motors with a special winding insulation for frequency converter supply, variant code 405. The "ABB Standard Insulation" curve applies to all other random wound motors covered by this catalogue.

2.2 Phase to ground voltages

The allowed phase to ground voltage peaks at the motor terminals are:

Standard Insulation 1300 V peak

Special Insulation 1800 V peak

2.3 Selection of winding insulation for ACS800 and ACS550 supplied motors

In the case of ABB ACS800 and ACS550 single drives with a diode supply unit (uncontrolled DC voltage), the motor winding insulation and frequency converter output filters can be selected using Table 2.

Table 2. Selection of motor winding insulation and converter output filters for motors used of ABB ACS800 or ACS550 drives with uncontrolled DC voltage.

Winding insulation and filters required	
$U_N \leq 500$ V	ABB Standard insulation
$U_N \leq 600$ V	ABB Standard insulation + dU/dt filters OR ABB Special insulation (variant code 405)
$U_N \leq 690$ V	ABB Special insulation (variant code 405) AND dU/dt-filters at converter output
600 V < $U_N \leq 690$ V cable length > 150 m	ABB Special insulation (variant code 405)

Nominal supply voltage U_N of converter
Winding insulation and filters required

$U_N \leq 500$ V ABB Standard Insulation
 $U_N \leq 600$ V ABB Standard Insulation + dU/dt filters
OR
ABB Special Insulation (variant code 405)
 $U_N \leq 690$ V ABB Special Insulation (variant code 405)
AND
dU/dt filters at converter output

For more information on dU/dt filters, please see relevant ABB Drives catalogues.

For more information on resistor braking and converters with controlled supply units, please contact ABB.

2.4 Selection of winding insulation with all other converters

The voltage stresses must be restricted so they remain below the accepted limits. The effect of any filters that are fitted must be taken into account when dimensioning the motor.

3. Bearing currents

Bearing voltages and currents must be avoided in all variable speed applications to ensure the reliability and safety of the application. For this purpose insulated bearings or bearing constructions, common mode filters and suitable cabling and grounding methods must be used.

3.1 Elimination of bearing currents with ABB ACS800 and ACS550 converters

In the case of ABB ACS800 and ACS550 converters with a diode supply unit (uncontrolled DC voltage), the following methods must be used to avoid harmful bearing currents in the motors:

Frame size	Preventive measures
250 and smaller	No action needed
280 – 315	Insulated non-drive end bearing
355 – 450	Insulated non-drive end bearing AND Common mode filter at the converter

Common mode filters

Common mode filters reduce common mode currents and thus decrease the risk of bearing currents. Common mode filters do not significantly affect the phase or main voltages on the motor terminals. For more information, please see ABB Drives catalogues

Insulated bearings

Bearings with aluminium oxide insulated and sealed inner or outer bores are used as standard. Hybrid bearings, i.e. bearings with non-conductive ceramic rolling elements, can also be used in special applications. More information for selecting the correct parts is available on request.

3.2 Elimination of bearing currents with all other converters

The user is responsible for protecting the motor and driven equipment from harmful bearing currents. The instructions provided in section 3.1 can be followed, but their effectiveness cannot be guaranteed in all cases.

4. Cabling, grounding and EMC

The use of a frequency converter places greater demands on the cabling and grounding of the drive system. To provide proper grounding and ensure compliance with any applicable EMC requirements, motors above 30 kW shall be cabled using shielded symmetrical cables and EMC glands, i.e. cable glands providing 360° bonding. Symmetrical and shielded cables are also highly recommended for smaller motors. For motors in frame size IEC 280 and upward, additional potential equalization between the motor frame and the driven equipment is needed, unless both are mounted on a common steel base. In this case, the high frequency conductivity of the connection provided by the steel base should be checked.

More information about grounding and cabling of variable speed drives can be found in the manual "Grounding and cabling of the drive system" (Code: 3AFY 61201998) and material on fulfilling the EMC requirements can be found on respective converter manuals.

Please note that proper cable glands providing 360° bonding, or equivalent, must also be used for the converter and safety switch, if fitted.

The correct grounding of the motor and driven equipment is also necessary for the avoidance of bearing voltages and currents.

D. Loadability curves of motors for explosive atmospheres

The loadability curves shown in Figures 2 and 3 are based on type tests using ACS800 frequency converters with DTC control. The loadability curves assume that the nominal frequency of the motor (i.e. field weakening point) is 50 Hz or 60 Hz and that the motor control mode (parameter 99.04) is DTC. The DriveSize dimensioning program also utilizes the same curves.

For VSDs other than DTC-controlled ACS800 converters, preliminary dimensioning can be done using the guideline loadability curves in Figures 4 and 5.

Loadability curves with ACS800 converters utilizing DTC control

Figure 2. Flameproof motors Ex d, Ex de T4, cast iron dust ignition proof motors, (DIP/Ex tD 150°C); nominal frequency of motor 50/60 Hz

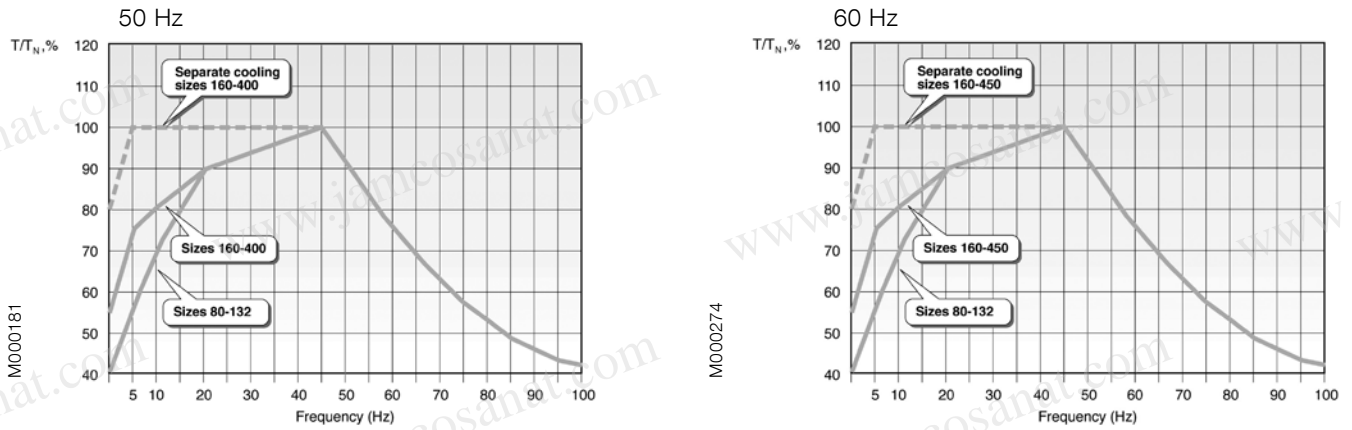
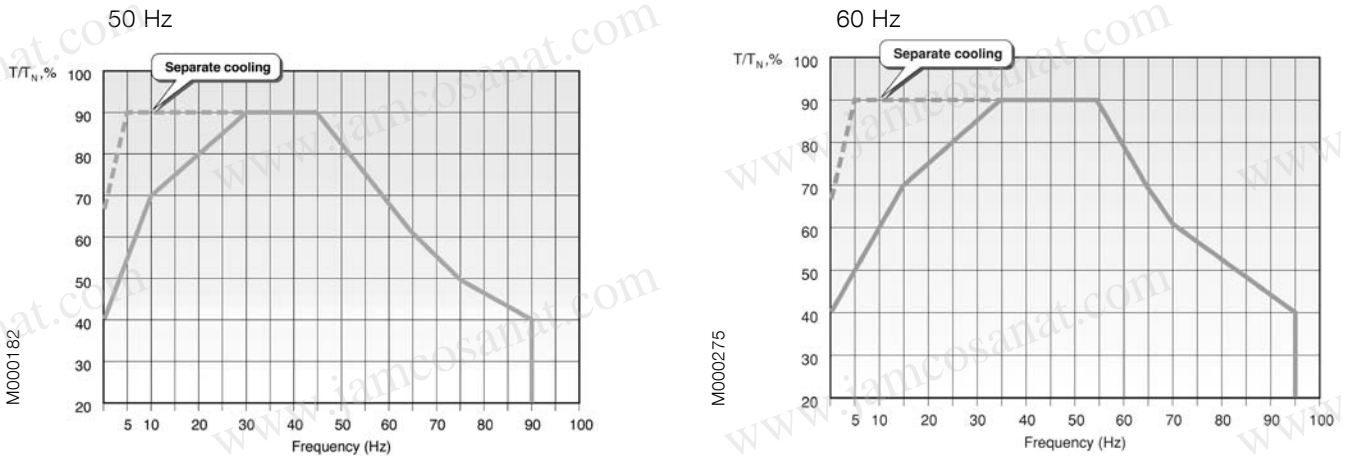
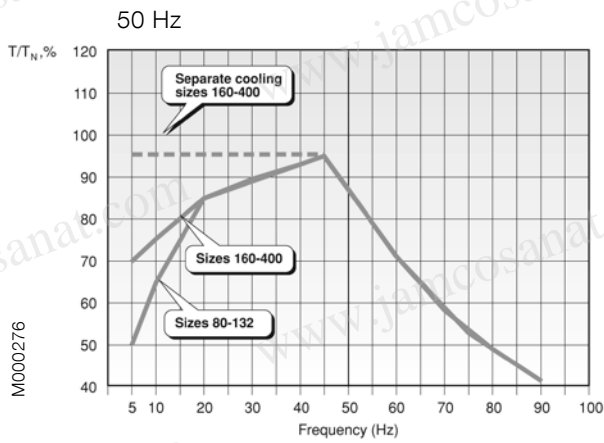

Figure 3. Non-sparking motors Ex nA, cast iron and aluminum dust ignition proof motors (DIP/Ex tD T125°C), nominal frequency of motor 50/60 Hz



Loadability curves with ACS 550 converters

Figure 4. Flameproof motors Ex d, Ex de T4, cast iron dust ignition proof motors (DIP/Ex tD T150°C); nominal frequency of motor 50/60 Hz



Note: Lower limit for constant torque is 15 Hz.

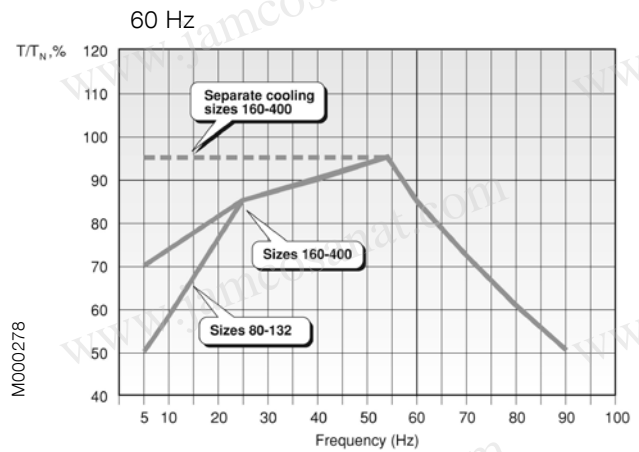

Note: Lower limit for constant torque is 18 Hz.

Figure 5. Non-sparking motors Ex nA, cast iron dust ignition proof motors (DIP/Ex tD T125°C); nominal frequency of motor 50/60 Hz

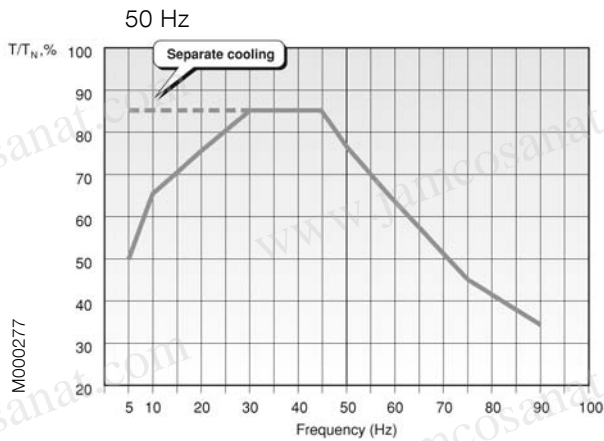

Note: Lower limit for constant torque is 15 Hz.

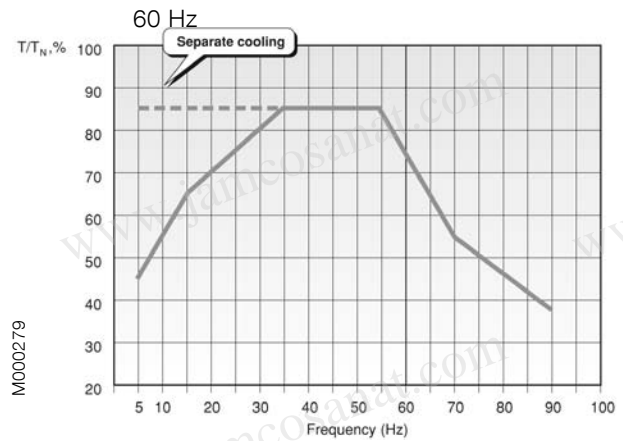

Note: Lower limit for constant torque is 18 Hz.

Loadability curves with other voltage source PWM-type converters

Figure 6. Flameproof motors Ex d, Ex de T4, cast iron dust ignition proof motors (DIP/Ex tD T150°C); nominal frequency of motor 50/60 Hz

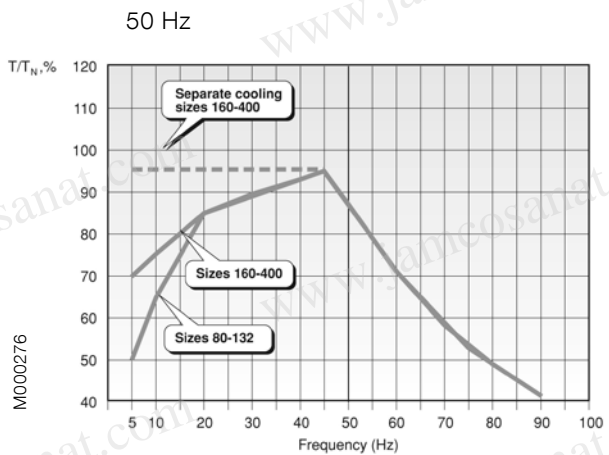

Note: Motors have to be protected against excessive surface temperatures by inbuilt direct temperature control.

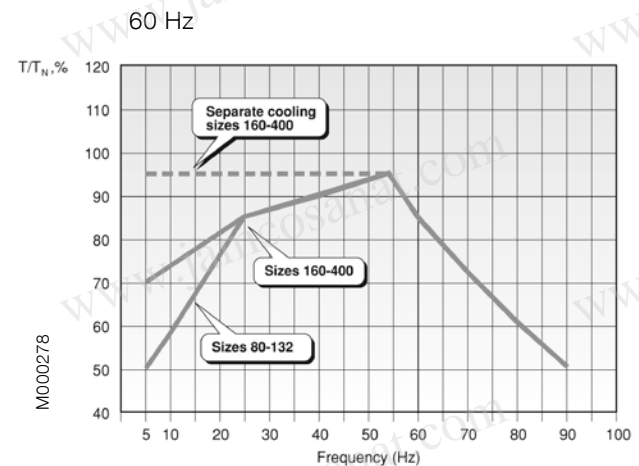

Flameproof motors Ex d IIB/IIC T4

Totally enclosed squirrel cage three phase low voltage motors, Sizes 80 - 400, 0.55 to 710 kW



www.abb.com/motors&generators

- > Motors for explosive atmospheres
- >> Flameproof motors



Mechanical design

Drain holes

Flameproof Ex d motors are provided without drain holes as standard.

Drain holes with certified metal plugs are available as an option. Please see variant code section.

Type of protection	Frame material	Frame size	Drain holes
Flameproof	Cast iron	80-400 160-400	not included optional

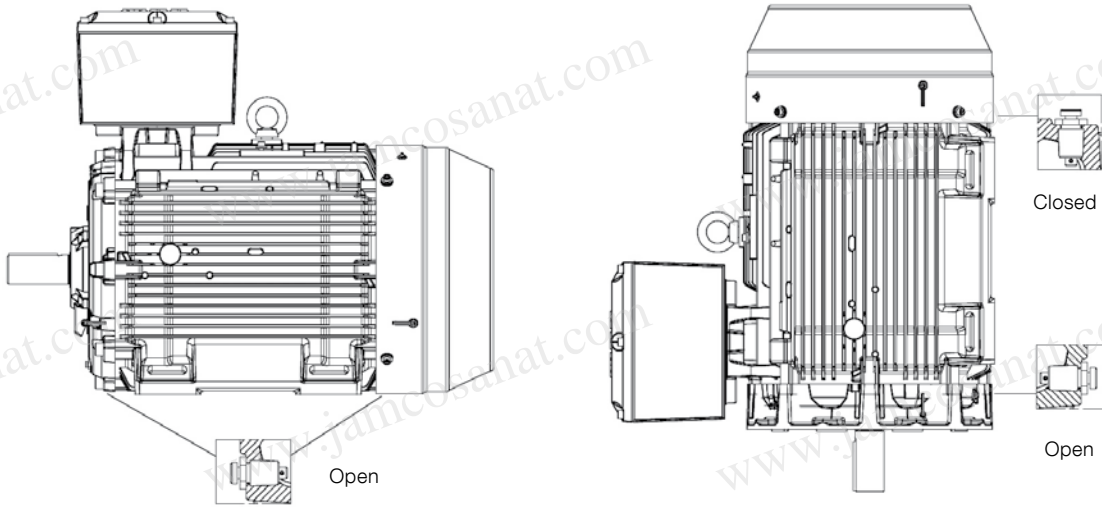

M000707

Terminal box standard delivery

Terminal boxes are mounted on top of the motor at D-end as standard. The terminal boxes of motor sizes 80-250 can be turned 4x90° and in motor sizes 280-400 2x180° after delivery. When ordering Exd motors in sizes 280-400 with 4x90°, the position of the terminal box has to be defined in the order.

The degree of protection of standard terminal box is IP55 and it complies with the requirements of this enclosure type and effectively prevents the transmission of an internal explosion to the surrounding, potentially explosive atmosphere.

If no ordering information on the cable is given, it is assumed to be p.v.c. -insulated non-armoured and termination parts are supplied according to the table on the following pages. To enable the supply of suitable terminations for the motor, please state cable type, quantity, size and outer diameter when ordering.

All Ex d motors are delivered as standard without cable glands. However, motors are provided with metal plugs according to the table below. Different glands can be provided separately as an option. Please see Alternatives section for details.

Note: For 500 V motor information please contact ABB!

Standard delivery 400/690 V (if nothing else informed)

Motor size	Pole number	Terminal box type	Threaded holes	Cable gland	Metal plug	Single core cross-section mm ² for rated power	Terminal bolt size 6 x
80-90	2-8	25	1xM25	-	1xM25	10	M5
100-132	2-8	25	2xM32	-	1xM32	10	M5
160-180	2-8	63	2xM40	-	1xM40	35	M6
200-250	2-8	160	2xM50	-	1xM50	70	M10
280	2-8	210	2xM63	-	1xM63	2x150	M12
315	2-8	370	2xM75	-	1xM75	2x240	M12
355	2-8	750	2xM75	-	1xM75	2x240	M12
400	2-8	750	2xM75	-	1xM75	2x240	M12

Auxiliary cable entries

80-132	2-8	1xM20	-	1xM20
160-400	2-8	2xM20	-	1xM20

Earthings on motor

	Frame	Terminal box
80-132	M6	M6
160-180	M6	M6
200-250	M8	M8
280-315	M10	2xM10
355-400	M10	2xM10

Examples of terminal boxes and connection parts
Below pictures show a collection of terminal boxes and connection parts.

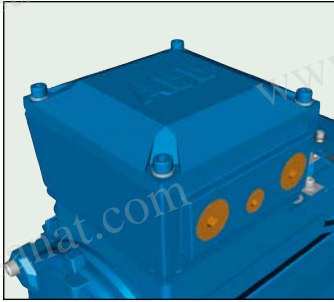

M000708

Fig 1. Terminal box for motor sizes 80-132



M000709

Fig 2. Terminal box for motor sizes 160-180

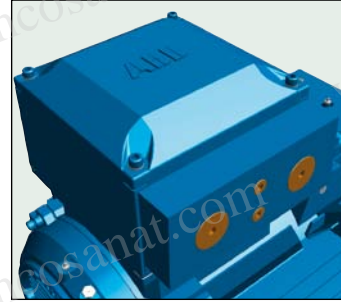

M000710

Fig 3. Terminal box for motor sizes 200-250

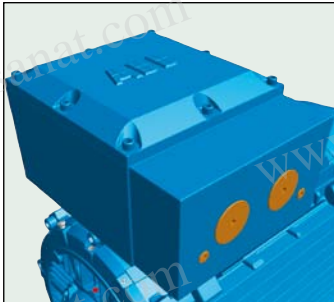

M000711

Fig 4. Terminal box for motor sizes 280-315

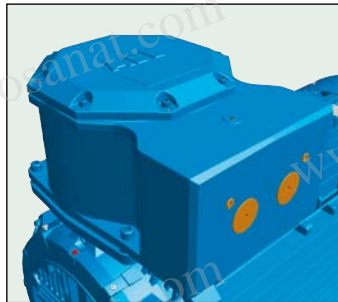

M000712

Fig 5. Terminal box for motor sizes 355-400



M000713

Fig 6. Terminal board for motor sizes 80-132

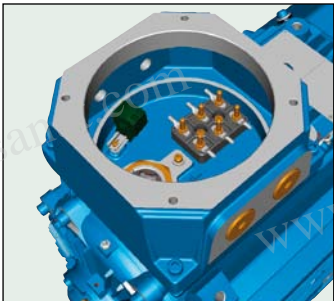

M000714

Fig 7. Terminal board for motor sizes 160-180

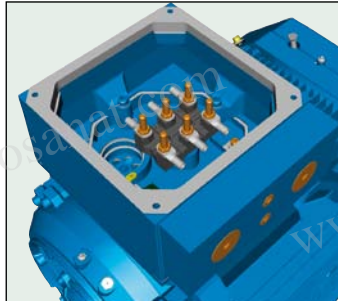

M000715

Fig 8. Terminal board for motor sizes 200-250



M000716

Fig 9. Terminal board for motor sizes 280-315



M000717

Fig 10. Terminal board for motor sizes 355-400

Terminal box alternatives, cast iron frame

Due to the construction of Ex d terminal box it is not possible to mount any connection flanges, adapters nor cable sealing end units on this type of terminal box.

Only for the cable gland type there are some alternatives. These can be found from the Variants section.

1. Main terminal box and maximum single core cross section

Larger than standard single core cross section is available as option according to the table below. Please check also the capacity of the cable entry to make sure the cables fit.

Standard terminal box	Size of opening	Max single cross section per phase mm ²
25	B	35
63	B	95
160	C	120
210	C	2 x 240
370	D	2 x 300
750	E	4 x 500

The accessories for using the maximum single core cross sections are not included as standard. For this option please use variant code 300 (Increased single core cross section). Each terminal has got limited maximum cable entry size, please request if necessary.

Dimension drawings Flameproof motors, Ex d

Terminal boxes, standard with 6 terminals

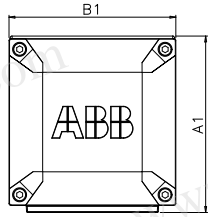

M000366

Motor sizes 80-132

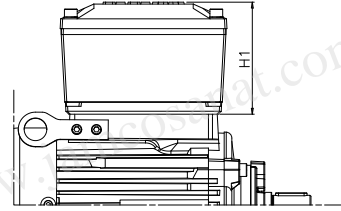

M000366

Motor sizes 160-180

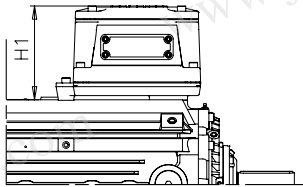

M000735

Motor sizes 200-250

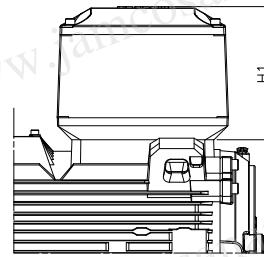

M000367

Motor sizes 280 - 315

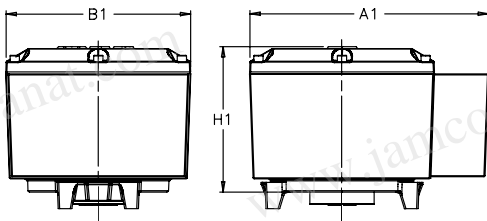

M000203

Motor sizes 355 - 400

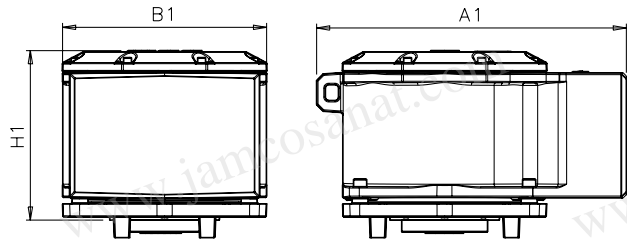

M000204

Ex d - M3JP

Motor size	Terminal box	A1	B1	H1
80-132	25	180	170	114
160-180	63	251	242	127
200-250	160	339	291	226
280	210	465	370	260
315-400	370	790	490	420
	750	707	466	387

For motor dimensions please see dimension drawings on earlier pages.

Permissible loadings on the shaft end

The following tables give the permissible radial and axial forces in Newton, assuming only radial or axial force is applied. Permissible loads of simultaneous radial and axial forces will be supplied on request.

The bearing life, L_{10} , is calculated according to ISO 281:1990/ Amd 2:2000 standard theory, which also takes the purity of the grease into consideration. An adequate lubrication is a necessary prerequisite for the table below.

The values are based on normal conditions at 50 Hz. At 60 Hz the values must be reduced by 10 %. For two-speed motors, the values must be based on the higher speed.

Motors are foot-mounted IM B3 version with force directed sideways. In some cases the strength of the shaft affects the permissible forces.

If flameproof motors Ex d sizes 160 and above are subject to high radial forces (e.g. belt drive) they should be fitted with roller bearings. Permissible radial forces for IIB and IIC are available from ABB on request.

Cast iron motors Permissible radial forces according to L_{10} principle Flameproof motor sizes 80-132

Motor size	Poles	Length of shaft extension E (mm)	40,000 hours	
			F_{X_0} (N)	$F_{X_{max}}$ (N)
80	2	40	619	524
	4	40	780	663
	6	40	893	759
	8	40	983	834
90	2	50	561	473
	4	50	803	677
	6	50	919	775
	8	50	1011	853
100	2	60	553	457
	4	60	1050	868
	6	60	1267	1047
	8	60	1395	1153
112	2	60	553	457
	4	60	1050	868
	6	60	1267	1047
	8	60	1394	1152
132	2	80	1354	1112
	4	80	1772	1454
	6	80	2028	1665
	8	80	2234	1833

Please note that motors type Ex d and IIC in size 250 and above with roller bearings may require detailed information about power transmission; please consult ABB.

If the radial force is applied between points X_0 and X_{max} , the permissible force F_R can be calculated from the following formula:

$$F_R = F_{X_0} - \frac{X}{E} (F_{X_0} - F_{X_{max}})$$

E = length of shaft extension in basic version

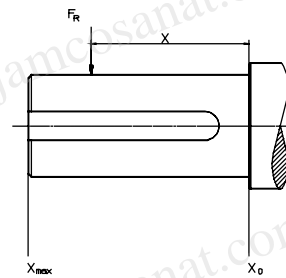

M000145

Cast iron motors

Permissible radial forces according to L₁₀ principle

Flameproof motors Ex d IIB/IIC, motor sizes 160 - 355

Motor size	Poles	Length of shaft extension E (mm)	Ball bearings IIB ²⁾ L ₁₀ h=40 000 h		Ball bearings IIB/IIC L ₁₀ h=40 000 h		Roller bearings IIB ²⁾ L ₁₀ h=40 000 h		Roller bearings IIC L ₁₀ h=40 000 h	
			FX ₀ [N]	FX _{max} [N]	FX ₀ [N]	FX _{max} [N]	FX ₀ [N]	FX _{max} [N]	FX ₀ [N]	F _{xmax} [N]
160 ML	2	110	2530	2120	2530	2120	6400	1800	6400	1800
	4	110	3180	2670	3180	2670	7600	1800	7600	1800
	6	110	3650	3040	3650	3040	7600	1800	7600	1800
	8	110	4020	3040	4020	3040	7600	1800	7600	1800
180 ML	2	110	2900	2440	2900	2440	6970	2700	6970	2700
	4	110	3660	3080	3660	3080	8500	2700	8500	2700
	6	110	4190	3520	4190	3520	8500	2700	8500	2700
	8	110	4620	3880	4620	3880	8500	2700	8500	2700
200 ML	2	110	3830	3150	3830	3150	9510	7000	9510	4200
	4	110	4820	3980	4820	3980	11710	7000	11710	4200
	6	110	5520	4550	5520	4550	13230	7000	13230	4200
	8	110	6080	5000	6080	5000	14420	7000	14420	4200
225 SM	2	110	4350	3660	4350	3660	11650	7000	9300	3000
	4	140	5490	2800	5490	2800	14340	7200	9300	2200
	6	140	6280	2800	6280	2800	16190	7200	9300	2200
	8	140	6920	2800	6920	2800	17300	7200	9300	2200
250 SM	2	140	5390	4350	5390	2900	15420	6700	¹⁾	¹⁾
	4	140	6790	5480	6790	2800	18980	9200	¹⁾	¹⁾
	6	140	7760	6270	3000	2800	21000	9200	¹⁾	¹⁾
	8	140	8550	6900	3000	2800	21000	9200	¹⁾	¹⁾
280 SM	2	140	5840	4900	³⁾	³⁾	16550	6000	Not available	
	4	140	7260	6110	³⁾	³⁾	20100	9200	Not available	
	6	140	8300	6980	³⁾	³⁾	22690	9200	Not available	
	8	140	9150	7700	³⁾	³⁾	24740	9200	Not available	
315 SM	2	140	5810	4960	³⁾	³⁾	16540	6000	Not available	
	4	170	9030	7470	³⁾	³⁾	26590	9600	Not available	
	6	170	10310	8530	³⁾	³⁾	39030	9600	Not available	
	8	170	11370	9410	³⁾	³⁾	32740	9600	Not available	
315 ML	2	140	5850	5080	³⁾	³⁾	16710	5850	Not available	
	4	170	9000	7620	³⁾	³⁾	26580	13040	Not available	
	6	170	10270	8500	³⁾	³⁾	30010	10040	Not available	
	8	170	11330	9380	³⁾	³⁾	32730	9940	Not available	
355 SM	2	140	5790	5090	³⁾	³⁾	Not available		Not available	
	4-8	210	11930	9890	³⁾	³⁾	Not available		Not available	
355 ML	2	140	5770	5120	³⁾	³⁾	Not available		Not available	
	4-8	210	11980	10090	³⁾	³⁾	Not available		Not available	
355 LK	2	140	5500	5000	³⁾	³⁾	Not available		Not available	
	4-8	210	12050	10450	³⁾	³⁾	Not available		Not available	
400 L	2	170	³⁾	³⁾	³⁾	³⁾	Not available		Not available	
	4-8	210	³⁾	³⁾	³⁾	³⁾	Not available		Not available	
400 LK	2	170	³⁾	³⁾	³⁾	³⁾	Not available		Not available	
	4-8	210	³⁾	³⁾	³⁾	³⁾	Not available		Not available	

¹⁾ On request

²⁾ IIB on request, requires special construction.

³⁾ Flameproof motors Ex d IIC - sizes 280-315 only allowed for direct coupling applications.

Permissible axial forces according to L₁₀ principle



Cast iron motors, sizes 80 - 400

Mounting arrangement IM B3

Motor size	20,000 hours								40,000 hours							
	2-pole		4-pole		6-pole		8-pole		2-pole		4-pole		6-pole		8-pole	
	F _{AD} N	F _{AZ} N	F _{AD} N	F _{AZ} N	F _{AD} N	F _{AZ} N	F _{AD} N	F _{AZ} N	F _{AD} N	F _{AZ} N	F _{AD} N	F _{AZ} N	F _{AD} N	F _{AZ} N	F _{AD} N	F _{AZ} N
80	820	460	1010	650	1180	820))))))))))
90	900	380	1110	590	1260	740))))))))))
100	1330	440	1620	730	1820	940))))))))))
112	1330	440	1610	720	1820	930))))))))))
132 S ₁	1880	850	2330	1290	2650	1610))))))))))
160	2820	1910	3560	2650	4150	3240	4630	3720	2220	1310	2780	1870	3230	2320	3590	2680
180	3190	2280	4080	3170	4720	3810	5260	4350	2500	1590	3160	2250	3640	2740	4060	3150
200	4230	2960	5380	4120	6270	5000	6960	5700	3320	2060	4184	2920	4850	3590	5380	4120
225	4740	3270	6070	4600	7020	5550	7830	6360	3720	2250	4720	3250	5430	3970	6050	4590
250	6470	3370	8100	5000	9250	6150	10220	7130	5220	2130	6440	3340	7300	4210	8040	4950
280 SM ₁	4200	6250	6000	8000	5250	11250	8300	10300	2900	4900	4250	6250	5150	7150	5950	7950
315 SM ₁	4180	6200	7400	9400	8900	10900	10000	12000	2850	4850	5250	7250	6350	8350	7200	9000
315 ML ₁	4050	6050	7250	9250	8650	10650	9500	11900	2750	4750	5100	7100	6100	8100	6900	8800
315 LK ₁	4000	5950	7100	9150	8500	10500	9750	11750	2650	4650	5000	7000	5950	7950	6900	8900

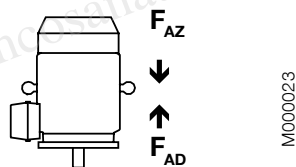

Mounting arrangement IM V1

Motor size	20,000 hours								40,000 hours							
	2-pole		4-pole		6-pole		8-pole		2-pole		4-pole		6-pole		8-pole	
	F _{AD} N	F _{AZ} N	F _{AD} N	F _{AZ} N	F _{AD} N	F _{AZ} N	F _{AD} N	F _{AZ} N	F _{AD} N	F _{AZ} N	F _{AD} N	F _{AZ} N	F _{AD} N	F _{AZ} N	F _{AD} N	F _{AZ} N
80	850	440	1060	650	1220	800))))))))))
90	940	350	1150	550	1320	690))))))))))
100	1400	390	1710	650	1940	860))))))))))
112	1410	380	1730	640	1950	850))))))))))
132 S ₁	2010	730	2520	1150	2890	1440))))))))))
160	3070	1660	4060	2320	4530	2890	4950	3350	2470	1060	3280	1530	3600	1970	3910	2310
180	3580	1980	4650	2680	5430	3340	5970	3890	2880	1280	3730	1760	4360	2260	4760	2680
200	4790	2480	6240	3550	7070	4300	7850	5020	3870	1560	5030	2340	5650	2890	6260	3430
225	5540	2670	7000	3860	8130	4700	8860	5480	4510	1650	5640	2500	6540	3100	7080	3700
250	7390	2640	9200	4080	10670	5000	11660	5970	6135	1380	7530	2410	8710	3040	9470	3780
280 SM ₁	5550	5150	7600	6550	9150	7500	10200	9000	4200	3800	5800	4750	7000	5350	7850	6700
315 SM ₁	5950	4600	9750	7500	11600	8300	13350	9900	4600	3300	7550	5300	9050	5750	10450	7000
315 ML ₁	6650	4300	10500	7050	12900	7800	13400	8300	5300	2900	8300	4900	10350	5250	11600	5400
315 LK ₁	7100	3350	11100	5850	13700	6100	14900	8300	5750	2450	8900	3700	11100	3550	12100	5450

¹⁾ On request

Rating plates

The rating plates are in table form giving values for speed, current and power factor for three voltages: 400V-415V-690V as standard. Other voltage and frequency combinations are possible and can be ordered with variant codes 002 or 209. Please see Variant code section.

The following information will be shown on the motor rating plate according to IEC 60034-30:2008:

- Lowest nominal efficiency at 100%, 75% and 50% rated load
- Efficiency level
- Year of manufacture
- Type of protection
- Apparatus group
- Temperature class
- Identification number of the certification body
- Certificate number (both ATEX and IECEx are stamped on the rating plate as standard)

Motor sizes 80-400

ABB Oy, Motors Vaasa, Finland						
CE 0081		IE2		Ex II 2G		
3 ~ Motor M3JP 225SMC 4 IMB3/IM1001						
Ex d IIB T4						
414141-44		2010		No. 3GF1000004		
		Ins.cl.		F		IP 55
V	Hz	kW	r/min	A	cos φ	Duty
690 Y	50	45	1477	45	0.88	S1
400 D	50	45	1477	78	0.88	S1
415 D	50	45	1479	77	0.86	S1
IE2 - 94.1% (100%) - 94.6% (75%) - 94.4% (50%)						
Prod. code 3GJP222230-ADG						
LCIE 00 ATEX 6029 / IECEx LCI 04.0005						
			Nmax		r/min	
6313/C3		6312/C3		425		kg
ABB			IEC 60034-1			

M000737

Ordering information

Sample order

When placing an order, please state the following minimum data in the order, as in example.

The product code of the motor is composed in accordance with the following example.

Motor type	M3JP 160 MLA
Pole number	2
Mounting arrangement (IM code)	IM B3 (IM 1001)
Rated output	11 kW
Product code	3GJP161410-ADH
Variant codes if needed	

Motor size

A	B	C	D.E.F.	G														
M3JP 160 MLA 3GJP 161 410 - A D H 002 etc.																		
<table border="1" style="width: 100%; border-collapse: collapse;"> <tr> <td style="width: 12.5%; text-align: center;">1</td> <td style="width: 12.5%; text-align: center;">2</td> <td style="width: 12.5%; text-align: center;">3</td> <td style="width: 12.5%; text-align: center;">4</td> <td style="width: 12.5%; text-align: center;">5</td> <td style="width: 12.5%; text-align: center;">6</td> <td style="width: 12.5%; text-align: center;">7</td> <td style="width: 12.5%; text-align: center;">8</td> <td style="width: 12.5%; text-align: center;">9</td> <td style="width: 12.5%; text-align: center;">10</td> <td style="width: 12.5%; text-align: center;">11</td> <td style="width: 12.5%; text-align: center;">12</td> <td style="width: 12.5%; text-align: center;">13</td> <td style="width: 12.5%; text-align: center;">14</td> </tr> </table>					1	2	3	4	5	6	7	8	9	10	11	12	13	14
1	2	3	4	5	6	7	8	9	10	11	12	13	14					
A Motor type		C Product code	E Voltage and frequency code	G Variant codes														
B Motor size		D Mounting arrangement code	F Generation code															

Explanation of the product code:

Positions 1 - 4

3GJP = Totally enclosed frameproof motor E xd with cast iron frame

Positions 5 and 6

IEC-frame size

08 = 80	20 = 200
09 = 90	22 = 225
10 = 100	25 = 250
11 = 112	28 = 280
13 = 132	31 = 315
16 = 160	35 = 355
18 = 180	40 = 400

Position 7

Speed (pole pairs)

1 = 2 poles	4 = 8 poles	7 ≥12 poles
2 = 4 poles	5 = 10 poles	8 = Two-speed motors
3 = 6 poles	6 = 12 poles	9 = Multi-speed motors

Position 8-10

Running number series

Position 11

- (Dash)

Position 12

Mounting arrangement

- A** = Foot-mounted, top mounted terminal box
- R** = Foot-mounted, terminal box RHS seen from D-end
- L** = Foot-mounted, terminal box LHS seen from D-end
- B** = Flange-mounted, large flange with clearance holes
- C** = Flange-mounted, small flange with tapped holes
- V** = Flange-mounted, Special flange
- H** = Foot/flange-mounted, large flange with clearance holes
- J** = Foot/flange-mounted, small flange with tapped holes
- S** = Foot/flange-mounted, terminal box RHS seen from D-end
- T** = Foot/flange-mounted, terminal box LHS seen from N-end
- F** = Foot/flange-mounted, special flange

Position 13

Voltage and frequency

Single-speed motors

- B** 380 VΔ 50 Hz
- D** 400 VΔ, 415 VΔ, 690 VY 50 Hz
- E** 500 VΔ 50 Hz
- F** 500 VY 50 Hz
- S** 230 VΔ, 400 VY, 415 VY 50 Hz
- T** 660 VΔ 50 Hz
- U** 690 VΔ 50 Hz
- X** Other rated voltage, connection or frequency, 690 V maximum

Position 14

Generation code G/H

Generation code is followed by variant codes according to the hazardous area, see below and on corresponding pages with variant codes:

461 Ex d(e) design, Group IIC

Flameproof cast iron motors Ex d IIB/IIC T4

Technical data for totally enclosed squirrel cage three phase motors

IE2

IP 55 - IC 411 - Insulation class F, temperature rise class B
IE2 efficiency class according to IEC 60034-30; 2008



Output kW	Motor type	Product code	Speed r/min	Efficiency IEC 60034-2-1; 2007			Power factor cos φ	Current			Torque			Moment of inertia J = 1/4 GD ² kgm ²	Weight kg	Sound pressure level L _{PA} dB	
				Full load 100%	3/4 load 75%	1/2 load 50%		I _N A	I _s I _N	T _N Nm	T _l T _N	T _b T _N					
3000 r/min = 2-poles			400 V 50 Hz			GENELEC-design											
0.75	M3JP	80 MA	3GJP	081 310-••H	2861	80.1	79.4	76.2	0.87	1.55	7.3	2.5	3.7	3.8	0.0006	37	59
1.1	M3JP	80 MB	3GJP	081 320-••H	2831	80.5	81.1	79.5	0.89	2.2	5.7	3.7	3.0	3.2	0.0007	39	59
1.5	M3JP	90 SLA	3GJP	091 010-••H	2881	81.9	82.1	80.1	0.88	3.0	6.7	4.9	3.0	3.5	0.001	50	61
2.2	M3JP	90 SLC	3GJP	091 030-••H	2871	84.4	85.0	83.8	0.90	4.1	7.5	7.3	2.7	3.5	0.0014	53	61
3	M3JP	100 LA	3GJP	101 510-••H	2896	85.2	85.5	84.0	0.90	5.6	7.2	9.8	2.2	3.0	0.0036	70	65
4	M3JP	112 MB	3GJP	111 320-••H	2901	85.9	86.5	85.3	0.90	7.4	7.2	13.1	3.6	3.7	0.0043	73	65
5.5	M3JP	132 SMB	3GJP	131 220-••H	2905	87.2	87.5	86.1	0.90	10.1	7.0	18.0	2.4	3.3	0.009	101	71
7.5	M3JP	132 SMD	3GJP	131 240-••H	2914	88.3	88.7	87.6	0.90	13.6	7.6	24.5	2.8	3.6	0.012	109	71
11	M3JP	160 MLA	3GJP	161 410-••H	2931	90.1	90.5	89.6	0.89	19.7	7.2	35.8	2.6	3.1	0.043	213	71
15	M3JP	160 MLB	3GJP	161 420-••H	2929	91.2	91.9	91.4	0.89	26.6	7.2	48.9	3.0	3.5	0.052	222	71
18.5	M3JP	160 MLC	3GJP	161 430-••H	2934	91.8	92.2	91.8	0.90	32.3	7.5	60.2	2.8	3.4	0.062	233	69
22	M3JP	180 MLA	3GJP	181 410-••H	2938	91.7	92.2	91.7	0.90	38.4	7.0	71.5	2.5	3.1	0.089	265	69
30	M3JP	200 MLA	3GJP	201 410-••G	2956	93.2	93.6	93.0	0.88	52.7	7.4	96.9	3.0	3.2	0.15	310	74
37	M3JP	200 MLC	3GJP	201 430-••G	2954	93.6	94.0	93.4	0.89	64.1	7.5	119	2.8	3.2	0.19	340	75
45	M3JP	225 SMB	3GJP	221 220-••G	2968	93.9	93.8	92.9	0.87	79.5	7.2	144	2.7	3.0	0.26	400	76
55	M3JP	250 SMA	3GJP	251 210-••G	2975	94.3	94.1	93.0	0.89	94.5	7.8	176	2.4	3.1	0.49	460	75
75	M3JP	280 SMA	3GJP	281 210-••G	2978	94.3	94.1	92.8	0.88	130	7.6	240	2.1	3.0	0.8	725	77
90	M3JP	280 SMB	3GJP	281 220-••G	2976	94.6	94.5	93.5	0.90	152	7.4	288	2.1	2.9	0.9	765	77
110	M3JP	315 SMA	3GJP	311 210-••G	2982	94.9	94.4	92.9	0.86	194	7.6	352	2.0	3.0	1.2	980	78
132	M3JP	315 SMB	3GJP	311 220-••G	2982	95.1	94.8	93.6	0.88	227	7.4	422	2.2	3.0	1.4	1040	78
160	M3JP	315 SMC	3GJP	311 230-••G	2981	95.4	95.2	94.2	0.89	271	7.5	512	2.3	3.0	1.7	1125	78
200	M3JP	315 MLA	3GJP	311 410-••G	2980	95.7	95.7	94.9	0.90	335	7.7	640	2.6	3.0	2.1	1290	78
250 ³⁾	M3JP	355 SMA	3GJP	351 210-••G	2984	95.7	95.5	94.5	0.89	423	7.7	800	2.1	3.3	3.0	1790	83
315 ³⁾	M3JP	355 SMB	3GJP	351 220-••G	2980	95.7	95.7	95.1	0.89	533	7.0	1009	2.1	3.0	3.4	1870	83
355 ³⁾	M3JP	355 SMC	3GJP	351 230-••G	2984	95.7	95.7	95.2	0.88	608	7.2	1136	2.2	3.0	3.6	1940	83
400 ³⁾	M3JP	355 MLA	3GJP	351 410-••G	2982	96.9	96.6	95.9	0.88	677	7.1	1280	2.3	2.9	4.1	2190	83
450 ³⁾	M3JP	355 MLB	3GJP	351 420-••G	2983	97.1	97.0	96.4	0.90	743	7.9	1440	2.2	2.9	4.3	2270	83
500 ³⁾	M3JP	355 LKA	3GJP	351 810-••G	2982	96.9	96.9	96.5	0.90	827	7.5	1601	2.0	3.9	4.8	2510	83
560 ⁴⁾	M3JP	400 LA	3GJP	401 510-••G	2988	97.2	97.2	96.6	0.89	934	7.8	1789	2.1	3.4	7.9	3230	82
560 ⁴⁾	M3JP	400 LKA	3GJP	401 810-••G	2988	97.2	97.2	96.6	0.89	934	7.8	1789	2.1	3.4	7.9	3230	82
630 ⁴⁾	M3JP	400 LB	3GJP	401 520-••G	2987	97.4	97.4	96.9	0.89	1048	7.8	2014	2.2	3.4	8.2	3330	82
630 ⁴⁾	M3JP	400 LKB	3GJP	401 820-••G	2987	97.4	97.4	96.9	0.89	1048	7.8	2014	2.2	3.4	8.2	3330	82
710 ⁴⁾	M3JP	400 LC	3GJP	401 530-••G	2987	97.5	97.4	97.0	0.89	1180	7.8	2269	2.6	3.4	9.3	3580	82
710 ⁴⁾	M3JP	400 LKC	3GJP	401 830-••G	2987	97.5	97.4	97.0	0.89	1180	7.8	2269	2.6	3.4	9.3	3580	82
3000 r/min = 2-poles			400 V 50 Hz			High-output design											
22 ²⁾	M3JP	160 MLD	3GJP	161 440-••H	2929	91.2	91.6	91.0	0.90	38.6	7.3	71.7	2.7	3.4	0.07	239	77
30	M3JP	180 MLB	3GJP	181 420-••H	2943	92.5	93.0	92.6	0.90	52.0	6.8	97.3	2.3	3.1	0.13	298	78
37	M3JP	180 MLC	3GJP	181 430-••H	2947	92.8	93.0	92.5	0.90	63.9	7.9	119	2.9	3.6	0.13	298	77
45	M3JP	200 MLE	3GJP	201 450-••G	2944	93.3	93.6	93.0	0.88	79.1	7.3	145	2.9	3.1	0.22	345	79
55	M3JP	225 SMC	3GJP	221 230-••G	2965	93.9	93.9	92.9	0.88	96.0	7.1	177	2.6	3.0	0.29	420	80
67 ⁵⁾	M3JP	225 SMD	3GJP	221 240-••G	2966	93.9	93.7	92.6	0.86	119	7.4	215	2.8	3.2	0.31	430	78
75	M3JP	250 SMB	3GJP	251 220-••G	2969	94.0	94.0	93.2	0.89	129	7.9	241	2.6	3.2	0.57	500	80
90 ¹⁾²⁾⁵⁾	M3JP	250 SMC	3GJP	251 230-••G	2965	94.0	94.2	93.7	0.90	153	7.7	289	2.6	3.1	0.59	510	80
110	M3JP	280 SMC	3GJP	281 230-••G	2978	95.1	95.0	94.2	0.90	185	7.9	352	2.4	3.0	1.15	825	77

¹⁾ Temperature rise class F

²⁾ Efficiency class IE1

³⁾ 3dB(A) sound pressure level reduction with unidirectional fan construction. Direction of rotation must be stated when ordering, see variant codes 044 and 045

⁴⁾ Unidirectional fan construction as standard. Direction of rotation must be stated when ordering, see variant codes 044 and 045

⁵⁾ For 400-415 V 50 Hz (380 V 50 Hz voltage code B)

The two bullets in the product code indicate choice of mounting arrangements, voltage and frequency code (see ordering information page).

I_s / I_N = Starting current

T_l / T_N = Locked rotor torque

T_b / T_N = Pull-out torque

Efficiency values are given according to IEC 60034-2-1; 2007. Please note that the values are not comparable without knowing the testing method. ABB has calculated the efficiency values according to indirect method, stray load losses (additional losses) determined from measuring.

Flameproof cast iron motors Ex d IIB/IIC T4

Technical data for totally enclosed squirrel cage three phase motors

IE2



IP 55 - IC 411 - Insulation class F, temperature rise class B
IE2 efficiency class according to IEC 60034-30; 2008

Output kW	Motor type	Product code	Speed r/min	Efficiency IEC 60034-2-1; 2007			Power factor cos φ	Current		Torque			Moment of inertia J = 1/4 GD ² kgm ²	Weight kg	Sound pressure level L _{PA} dB
				Full load 100%	3/4 load 75%	1/2 load 50%		I _N A	I _s I _N	T _N Nm	T _l T _N	T _b T _N			
1500 r/min = 4-poles			400 V 50 Hz			CENELEC-adesign									
0.55	M3JP 80 MA	3GJP 082 310-••H	1421	75.4	75.4	72.7	0.76	1.38	4.9	3.6	2.3	2.7	0.001	38	59
0.75	M3JP 80 MB	3GJP 082 320-••H	1412	80.4	80.5	78.4	0.76	1.77	5.2	5.0	2.2	2.7	0.0012	38	59
1.1	M3JP 90 SLA	3GJP 092 010-••H	1435	81.8	81.8	79.5	0.81	2.3	5.9	7.3	2.8	3.5	0.002	51	54
1.5	M3JP 90 SLC	3GJP 092 030-••H	1431	83.2	82.8	80.4	0.79	3.2	6.5	10.0	2.3	3.0	0.003	53	54
2.2	M3JP 100 LA	3GJP 102 510-••H	1441	84.7	85.6	84.8	0.86	4.3	7.0	14.5	2.7	3.3	0.0075	70	52
3	M3JP 100 LB	3GJP 102 520-••H	1442	85.7	86.5	85.7	0.83	6.0	7.0	19.8	2.7	3.4	0.0081	72	52
4	M3JP 112 MC	3GJP 112 330-••H	1455	86.9	86.4	83.8	0.76	8.7	8.3	26.2	3.0	3.8	0.013	81	52
5.5	M3JP 132 SMB	3GJP 132 220-••H	1458	87.7	87.8	86.2	0.79	11.4	7.0	36.0	3.0	3.5	0.023	111	60
7.5	M3JP 132 SMD	3GJP 132 240-••H	1460	89.1	89.1	87.6	0.75	16.1	6.8	49.0	3.3	3.7	0.034	114	60
11	M3JP 160 MLC	3GJP 162 430-••H	1470	91.2	91.5	90.6	0.82	21.2	7.8	71.4	3.0	3.5	0.096	232	62
15	M3JP 160 MLE	3GJP 162 450-••H	1467	92.0	92.4	92.1	0.84	28.0	7.8	97.6	3.0	3.5	0.13	255	61
18.5	M3JP 180 MLA	3GJP 182 410-••H	1474	91.6	92.0	91.2	0.83	35.1	7.2	119	2.6	3.1	0.19	277	62
22	M3JP 180 MLB	3GJP 182 420-••H	1471	91.6	92.4	92.2	0.83	41.7	6.8	142	2.5	3.0	0.21	285	62
30	M3JP 200 MLB	3GJP 202 420-••G	1475	93.6	94.0	93.7	0.85	54.4	7.4	194	3.0	2.8	0.34	340	61
37	M3JP 225 SMB	3GJP 222 220-••G	1480	93.6	93.9	93.4	0.85	67.1	7.6	238	3.2	2.9	0.42	390	67
45	M3JP 225 SMC	3GJP 222 230-••G	1477	94.1	94.6	94.4	0.88	78.4	7.6	290	3.2	2.7	0.49	425	67
55	M3JP 250 SMA	3GJP 252 210-••G	1479	94.3	94.3	93.6	0.84	100	7.2	355	2.5	3.1	0.72	450	66
75	M3JP 280 SMA	3GJP 282 210-••G	1484	94.5	94.5	93.9	0.85	134	6.9	482	2.5	2.8	1.25	725	68
90	M3JP 280 SMB	3GJP 282 220-••G	1483	94.7	94.8	94.4	0.86	159	7.2	579	2.5	2.7	1.5	765	68
110	M3JP 315 SMA	3GJP 312 210-••G	1487	95.1	95.1	94.3	0.86	194	7.2	706	2.0	2.5	2.3	1000	70
132	M3JP 315 SMB	3GJP 312 220-••G	1487	95.4	95.4	94.7	0.86	232	7.1	847	2.3	2.7	2.6	1060	70
160	M3JP 315 SMC	3GJP 312 230-••G	1487	95.6	95.6	95.1	0.85	284	7.2	1027	2.4	2.9	2.9	1100	70
200	M3JP 315 MLA	3GJP 312 410-••G	1486	95.6	95.6	95.3	0.86	351	7.2	1285	2.5	2.9	3.5	1260	70
250	M3JP 355 SMA	3GJP 352 210-••G	1488	95.9	95.9	95.5	0.86	437	7.1	1604	2.3	2.7	5.9	1800	74
315	M3JP 355 SMB	3GJP 352 220-••G	1488	95.9	95.9	95.6	0.86	551	7.3	2021	2.3	2.8	6.9	1970	74
355	M3JP 355 SMC	3GJP 352 230-••G	1487	95.9	95.9	95.7	0.86	621	6.8	2279	2.4	2.7	7.2	2010	78
400	M3JP 355 MLA	3GJP 352 410-••G	1489	96.3	96.3	95.9	0.85	705	6.8	2565	2.3	2.6	8.4	2330	78
450	M3JP 355 MLB	3GJP 352 420-••G	1490	96.8	96.8	96.3	0.86	780	6.9	2884	2.3	2.9	8.4	2330	78
500	M3JP 355 LKA	3GJP 352 810-••G	1490	97.0	97.0	96.5	0.86	865	6.8	3204	2.0	3.0	10.0	2690	78
560	M3JP 400 LA	3GJP 402 510-••G	1491	96.8	96.8	96.3	0.85	982	7.4	3586	2.4	2.8	15.0	3200	78
560	M3JP 400 LKA	3GJP 402 810-••G	1491	96.8	96.8	96.3	0.85	982	7.4	3586	2.4	2.8	15.0	3200	78
630	M3JP 400 LB	3GJP 402 520-••G	1491	97.0	97.0	96.5	0.87	1077	7.6	4034	2.2	2.9	16.0	3580	78
630	M3JP 400 LKB	3GJP 402 820-••G	1491	97.0	97.0	96.5	0.87	1077	7.6	4034	2.2	2.9	16.0	3580	78
710 ¹⁾	M3JP 400 LC	3GJP 402 530-••G	1491	97.1	97.1	96.6	0.86	1227	7.6	4547	2.4	3.0	17.0	3680	78
710 ¹⁾	M3JP 400 LKC	3GJP 402 830-••G	1491	97.1	97.1	96.6	0.86	1227	7.6	4547	2.4	3.0	17.0	3680	78
1500 r/min = 4-poles			400 V 50 Hz			High-output design									
18.5	M3JP 160 MLF	3GJP 162 460-••H	1469	91.7	92.1	91.4	0.83	35.0	7.8	120	3.2	3.5	0.13	255	68
22 ²⁾	M3JP 160 MLG	3GJP 162 470-••H	1466	90.8	91.1	90.4	0.81	43.1	7.9	143	3.3	3.6	0.13	255	68
30 ¹⁾²⁾	M3JP 180 MLC	3GJP 182 430-••H	1473	92.2	92.3	91.6	0.81	57.9	7.1	194	2.8	3.2	0.248	304	66
37	M3JP 200 MLC	3GJP 202 430-••G	1475	93.0	93.1	92.3	0.82	70.0	7.5	239	3.5	3.2	0.34	340	73
55	M3JP 225 SMD	3GJP 222 240-••G	1483	94.3	94.5	93.9	0.83	101	7.4	354	3.4	2.9	0.55	445	68
62 ²⁾³⁾	M3JP 225 SME	3GJP 222 250-••G	1477	93.5	93.7	93.0	0.84	113	7.7	400	3.5	2.9	0.55	445	74
75	M3JP 250 SMB	3GJP 252 220-••G	1476	94.3	94.5	94.2	0.86	133	7.6	485	2.8	3.2	0.88	505	73
86 ²⁾	M3JP 250 SMC	3GJP 252 230-••G	1477	94.1	94.4	94.0	0.85	155	7.8	556	2.9	3.5	0.98	530	74
110	M3JP 280 SMC	3GJP 282 230-••G	1485	95.1	95.2	94.7	0.86	194	7.6	707	3.0	3.0	1.85	825	68

¹⁾ Temperature rise class F

²⁾ Efficiency class IE1

³⁾ For 400-415 V 50 Hz (380 V 50 Hz voltage code B)

The two bullets in the product code indicate choice of mounting arrangements, voltage and frequency code (see ordering information page).

I_s / I_N = Starting current

T_l / T_N = Locked rotor torque

T_b / T_N = Pull-out torque

Efficiency values are given according to IEC 60034-2-1; 2007. Please note that the values are not comparable without knowing the testing method.

ABB has calculated the efficiency values according to indirect method, stray load losses (additional losses) determined from measuring.

Flameproof cast iron motors Ex d IIB/IIC T4

Technical data for totally enclosed squirrel cage three phase motors

IE2

IP 55 - IC 411 - Insulation class F, temperature rise class B
IE2 efficiency class according to IEC 60034-30; 2008



Output kW	Motor type	Product code	Speed r/min	Efficiency IEC 60034-2-1; 2007			Power factor cos φ	Current _____ Torque _____					Moment of inertia J = 1/4 GD ² kgm ²	Weight kg	Sound pressure level L _{PA} dB
				Full load 100%	3/4 load 75%	1/2 load 50%		I _N A	I _s I _N	T _N Nm	T _I T _N	T _b T _N			
1000 r/min = 6-poles 400 V 50 Hz			CENELEC-design												
0.37	M3JP 80 MA	3GJP 083 310-••H	953	72.6	70.3	64.6	0.64	1.14	4.8	3.7	3.4	3.6	0.0022	38	50
0.55	M3JP 80 MB	3GJP 083 320-••H	938	72.9	71.7	67.0	0.70	1.55	4.3	5.5	2.8	2.9	0.0022	38	50
0.75	M3JP 90 SLA	3GJP 093 010-••H	946	77.9	77.1	73.4	0.69	2.0	4.9	7.5	2.1	2.8	0.0037	52	44
1.1	M3JP 90 SLC	3GJP 093 030-••H	933	78.5	78.8	76.3	0.71	2.8	4.7	11.2	1.8	2.4	0.0048	53	44
1.5	M3JP 100 LA	3GJP 103 510-••H	951	80.1	80.0	77.4	0.74	3.6	4.2	15.0	2.3	2.9	0.012	69	54
2.2	M3JP 112 MB	3GJP 113 320-••H	950	82.0	82.5	80.6	0.76	5.0	5.9	22.1	2.2	2.8	0.014	72	54
3	M3JP 132 SMB	3GJP 133 220-••H	961	83.3	83.0	80.4	0.77	6.7	6.1	29.8	2.1	3.0	0.032	105	57
4	M3JP 132 SMC	3GJP 133 230-••H	964	84.6	84.3	81.8	0.74	9.2	6.6	39.6	2.3	3.4	0.034	107	57
5.5	M3JP 132 SMD	3GJP 133 240-••H	967	87.6	87.5	85.7	0.72	12.5	6.9	54.3	2.3	3.4	0.039	109	62
7.5	M3JP 160 MLA	3GJP 163 410-••H	965	87.2	88.4	88.2	0.81	15.3	6.5	74.2	1.9	3.0	0.088	226	57
11	M3JP 160 MLB	3GJP 163 420-••H	972	90.1	90.8	90.4	0.81	21.7	7.8	108	2.3	3.5	0.126	253	65
15	M3JP 180 MLB	3GJP 183 420-••H	972	90.4	91.0	90.4	0.82	29.2	7.2	147	1.9	3.2	0.25	304	58
18.5	M3JP 200 MLA	3GJP 203 410-••G	983	90.9	91.1	90.2	0.82	35.8	7.1	179	3.2	3.1	0.37	300	66
22	M3JP 200 MLB	3GJP 203 420-••G	983	91.6	91.9	91.0	0.82	42.2	7.5	213	3.2	3.2	0.43	320	61
30	M3JP 225 SMB	3GJP 223 220-••G	985	92.2	92.6	92.2	0.82	57.2	7.4	290	3.4	3.0	0.64	385	61
37	M3JP 250 SMA	3GJP 253 210-••G	987	93.1	93.4	92.8	0.81	70.8	7.2	357	3.2	2.9	1.16	455	66
45	M3JP 280 SMA	3GJP 283 210-••G	990	93.4	93.6	93.1	0.84	82.7	7.0	434	2.5	2.5	1.85	705	66
55	M3JP 280 SMB	3GJP 283 220-••G	990	93.8	94.0	93.3	0.84	100	7.0	530	2.7	2.6	2.2	745	66
75	M3JP 315 SMA	3GJP 313 210-••G	992	94.4	94.4	93.5	0.82	139	7.4	721	2.4	2.8	3.2	930	70
90	M3JP 315 SMB	3GJP 313 220-••G	992	94.8	94.8	94.2	0.84	163	7.5	866	2.4	2.8	4.1	1030	70
110	M3JP 315 SMC	3GJP 313 230-••G	991	95.0	95.0	94.6	0.83	201	7.4	1059	2.5	2.9	4.9	1100	70
132	M3JP 315 MLA	3GJP 313 410-••G	991	95.3	95.4	94.9	0.83	240	7.5	1271	2.7	3.0	5.8	1250	68
160	M3JP 355 SMA	3GJP 353 210-••G	993	95.4	95.4	94.8	0.83	291	7.0	1538	2.0	2.6	7.9	1630	75
200	M3JP 355 SMB	3GJP 353 220-••G	993	95.7	95.7	95.1	0.84	359	7.2	1923	2.2	2.7	9.7	1790	75
250	M3JP 355 SMC	3GJP 353 230-••G	993	95.7	95.7	95.1	0.83	454	7.4	2404	2.6	2.9	11.3	2010	75
315	M3JP 355 MLB	3GJP 353 420-••G	992	95.7	95.7	95.2	0.83	572	7.0	3032	2.5	2.7	13.5	2370	75
355	M3JP 355 LKA	3GJP 353 810-••G	992	95.7	95.7	95.1	0.83	645	7.6	3417	2.7	2.9	15.5	2690	75
400	M3JP 400 LA	3GJP 403 510-••G	993	96.2	96.3	95.8	0.82	731	7.1	3846	2.3	2.7	17.0	3180	76
400	M3JP 400 LKA	3GJP 403 810-••G	993	96.2	96.3	95.8	0.82	731	7.1	3846	2.3	2.7	17.0	3180	76
450	M3JP 400 LB	3GJP 403 520-••G	994	96.6	96.6	96.1	0.82	819	7.4	4323	2.4	2.8	20.5	3430	76
450	M3JP 400 LKB	3GJP 403 820-••G	994	96.6	96.6	96.1	0.82	819	7.4	4323	2.4	2.8	20.5	3430	76
500	M3JP 400 LC	3GJP 403 530-••G	993	96.6	96.7	96.2	0.83	900	7.2	4808	2.5	2.7	22.0	3580	76
500	M3JP 400 LKC	3GJP 403 830-••G	993	96.6	96.7	96.2	0.83	900	7.2	4808	2.5	2.7	22.0	3580	76
560	M3JP 400 LD	3GJP 403 540-••G	993	96.9	96.9	96.4	0.85	981	7.4	5385	2.4	2.8	24.0	3680	77
560	M3JP 400 LKD	3GJP 403 840-••G	993	96.9	96.9	96.4	0.85	981	7.4	5385	2.4	2.8	24.0	3680	77
1000 r/min = 6-poles 400 V 50 Hz			High-output design												
14 ^{1) 2)}	M3JP 160 MLC	3GJP 163 430-••H	969	89.2	89.4	88.0	0.75	30.2	7.9	137	2.8	3.9	0.126	253	64
18.5 ²⁾	M3JP 180 MLC	3GJP 183 430-••H	975	90.1	90.2	88.7	0.74	40.0	7.2	181	2.0	3.2	0.25	304	61
30 ²⁾	M3JP 200 MLC	3GJP 203 430-••G	983	91.6	91.7	90.5	0.80	59.0	7.5	291	3.5	3.4	0.49	340	65
37 ²⁾	M3JP 225 SMC	3GJP 223 230-••G	983	92.1	92.5	92.1	0.83	69.8	7.1	359	3.0	2.8	0.75	415	64
45	M3JP 250 SMB	3GJP 253 220-••G	986	93.1	93.3	92.6	0.82	85.0	7.2	435	3.3	2.8	1.49	500	65
75	M3JP 280 SMC	3GJP 283 230-••G	990	94.2	94.5	94.1	0.84	136	7.3	723	2.8	2.7	2.85	825	66

¹⁾ Temperature rise class F

²⁾ Efficiency class IE1

The two bullets in the product code indicate choice of mounting arrangements, voltage and frequency code (see ordering information page).

I_s / I_N = Starting current

T_I / T_N = Locked rotor torque

T_b / T_N = Pull-out torque

Efficiency values are given according to IEC 60034-2-1; 2007. Please note that the values are not comparable without knowing the testing method.

ABB has calculated the efficiency values according to indirect method, stray load losses (additional losses) determined from measuring.

Flameproof cast iron motors Ex d IIB/IIC T4

Technical data for totally enclosed squirrel cage three phase motors



IP 55 - IC 411 - Insulation class F, temperature rise class B

Output kW	Motor type	Product code	Speed r/min	Efficiency IEC 60034-2-1: 2007			Power factor cos φ	Current		Torque			Moment of inertia J = 1/4 GD ² kgm ²	Weight kg	Sound pressure level L _{PA} dB
				Full load 100%	3/4 load 75%	1/2 load 50%		I _N A	I _s I _N	T _N Nm	T _I T _N	T _b T _N			
750 r/min = 8-poles 400 V 50 Hz			GENELEC-design												
0.18	M3JP 80 MA	3GJP 084 310-••H	720	61.0	56.4	48.3	0.48	0.88	3.3	2.3	3.7	4.0	0.0022	38	36
0.25	M3JP 80 MB	3GJP 084 320-••H	705	63.8	61.1	54.6	0.58	0.97	3.2	3.3	2.6	2.8	0.0022	38	36
0.37	M3JP 90 SLA	3GJP 094 010-••H	696	67.9	67.9	63.9	0.63	1.24	3.0	5.0	2.0	2.2	0.0036	50	36
0.55	M3JP 90 SLC	3GJP 094 030-••H	695	68.7	68.5	64.4	0.61	1.89	3.1	7.5	2.2	2.4	0.0037	52	36
0.75	M3JP 100 LA	3GJP 104 510-••H	720	75.9	74.1	69.1	0.59	2.4	3.8	9.9	2.0	2.9	0.012	69	54
1.1	M3JP 100 LB	3GJP 104 520-••H	717	76.4	74.9	70.2	0.57	3.6	3.7	14.6	2.1	2.9	0.012	69	54
1.5	M3JP 112 MC	3GJP 114 330-••H	713	77.2	76.4	72.4	0.59	4.7	3.5	20.0	2.0	2.7	0.014	73	54
2.2	M3JP 132 SMC	3GJP 134 230-••H	720	80.1	79.8	76.7	0.65	6.0	4.7	29.1	2.0	2.9	0.034	107	59
3	M3JP 132 SMD	3GJP 134 240-••H	710	79.9	81.5	80.6	0.70	7.7	4.1	40.3	1.7	2.3	0.036	109	59
4	M3JP 160 MLA	3GJP 164 410-••H	722	86.7	87.4	86.6	0.71	9.3	5.4	52.9	1.7	2.8	0.133	251	59
5.5	M3JP 160 MLB	3GJP 164 420-••H	723	86.8	87.6	86.8	0.71	12.8	5.8	72.6	1.9	3.1	0.133	251	53
7.5	M3JP 160 MLC	3GJP 164 430-••H	718	85.5	86.3	85.5	0.70	18.0	5.7	99.7	2.1	3.1	0.133	251	55
11	M3JP 180 MLB	3GJP 184 420-••H	723	88.3	89.2	88.7	0.72	24.9	5.7	145	1.7	2.7	0.245	298	63
15	M3JP 200 MLA	3GJP 204 410-••G	734	89.9	90.3	89.6	0.79	30.4	7.0	195	2.4	3.2	0.45	315	56
18.5	M3JP 225 SMA	3GJP 224 210-••G	734	90.0	90.3	89.3	0.74	40.0	6.1	240	2.2	3.0	0.61	370	55
22	M3JP 225 SMB	3GJP 224 220-••G	732	90.6	91.2	90.6	0.77	45.5	6.5	287	2.2	2.9	0.68	385	56
30	M3JP 250 SMA	3GJP 254 210-••G	735	91.4	91.2	90.7	0.78	60.7	6.7	389	2.0	2.9	1.25	455	56
37	M3JP 280 SMA	3GJP 284 210-••G	741	92.7	92.7	91.6	0.78	73.8	7.3	476	1.7	3.0	1.85	705	65
45	M3JP 280 SMB	3GJP 284 220-••G	741	93.2	93.2	92.2	0.78	89.3	7.6	579	1.8	3.1	2.2	745	65
55	M3JP 315 SMA	3GJP 314 210-••G	742	93.4	93.5	92.7	0.81	104	7.1	707	1.6	2.7	3.2	930	62
75	M3JP 315 SMB	3GJP 314 220-••G	741	93.7	93.9	93.4	0.82	140	7.1	966	1.7	2.7	4.1	1030	62
90	M3JP 315 SMC	3GJP 314 230-••G	741	94.0	94.2	93.6	0.82	168	7.4	1159	1.8	2.7	4.9	1100	64
110	M3JP 315 MLA	3GJP 314 410-••G	740	94.0	94.3	94.0	0.83	203	7.3	1419	1.8	2.7	5.8	1250	72
132	M3JP 355 SMA	3GJP 354 210-••G	744	94.7	94.7	94.0	0.80	251	7.5	1694	1.5	2.6	7.9	1630	69
160	M3JP 355 SMB	3GJP 354 220-••G	744	95.2	95.2	94.5	0.80	303	7.6	2053	1.6	2.6	9.7	1790	69
200	M3JP 355 SMC	3GJP 354 230-••G	743	95.3	95.4	94.8	0.80	378	7.4	2570	1.6	2.6	11.3	1930	69
250	M3JP 355 MLB	3GJP 354 420-••G	743	95.4	95.5	95.0	0.80	472	7.5	3213	1.6	2.7	13.5	2370	72
315	M3JP 400 LA	3GJP 404 510-••G	744	96.1	96.2	95.8	0.81	584	7.0	4043	1.2	2.6	17.0	3180	71
315	M3JP 400 LKA	3GJP 404 810-••G	744	96.1	96.2	95.8	0.81	584	7.0	4043	1.2	2.6	17.0	3180	71
355	M3JP 400 LB	3GJP 404 520-••G	743	96.2	96.3	96.1	0.83	641	6.8	4562	1.2	2.5	21.0	3480	71
355	M3JP 400 LKB	3GJP 404 820-••G	743	96.2	96.3	96.1	0.83	641	6.8	4562	1.2	2.5	21.0	3480	71
400	M3JP 400 LC	3GJP 404 530-••G	744	96.3	96.4	96.0	0.82	731	7.4	5134	1.3	2.7	24.0	3680	71
400	M3JP 400 LKC	3GJP 404 830-••G	744	96.3	96.4	96.0	0.82	731	7.4	5134	1.3	2.7	24.0	3680	71
750 r/min = 8-poles 400 V 50 Hz			High-output design												
18.5	M3JP 200 MLB	3GJP 204 420-••G	734	89.8	90.2	89.6	0.80	37.1	6.9	240	2.2	3.2	0.54	335	57
30	M3JP 225 SMC	3GJP 224 230-••G	731	90.7	91.5	91.3	0.78	61.2	6.3	391	2.3	3.0	0.75	410	59
37	M3JP 250 SMB	3GJP 254 220-••G	737	92.2	91.7	91.0	0.78	74.2	7.5	479	2.3	3.4	1.52	500	59
55	M3JP 280 SMC	3GJP 284 230-••G	741	93.4	93.5	92.8	0.80	106	7.9	708	1.9	3.1	2.85	825	65

The two bullets in the product code indicate choice of mounting arrangements, voltage and frequency code (see ordering information page).

I_s / I_N = Starting current
T_I / T_N = Locked rotor torque
T_b / T_N = Pull-out torque

Efficiency values are given according to IEC 60034-2-1: 2007. Please note that the values are not comparable without knowing the testing method. ABB has calculated the efficiency values according to indirect method, stray load losses (additional losses) determined from measuring.

Flameproof motors Ex d IIB/IIC T4 variant codes

Code ¹⁾	Variant	Frame Size													
		80	90	100	112	132	160	180	200	225	250	280	315	355	400
Administration															
531	Sea freight packing	M	M	M	M	M	M	M	M	M	M	M	P	P	P
Balancing															
417	Vibration acc. to Grade B (IEC 60034-14).	P	P	P	P	P	P	P	P	P	P	P	P	P	P
423	Balanced without key	P	P	P	P	P	P	P	P	P	P	P	P	P	P
424	Full key balancing.	P	P	P	P	P	P	P	P	P	P	P	P	P	P
Bearings and Lubrication															
036	Transport lock for bearings.	NA	NA	NA	NA	NA	NA	NA	NA	NA	NA	P	P	P	P
037	Roller bearing at D-end.	NA	NA	NA	NA	NA	M	M	M	M	M	M	P	NA	NA
040	Heat resistant grease.	S	S	S	S	S	P	P	P	P	P	P	P	P	P
041	Bearings regreasable via grease nipples.	NA	NA	NA	NA	NA	S	S	S	S	S	S	S	S	S
043	SPM compatible nipples for vibration measurement	NA	NA	NA	NA	NA	S	S	S	S	S	S	S	S	S
058	Angular contact bearing at D-end, shaft force away from bearing.	NA	NA	NA	NA	NA	NA	NA	NA	NA	NA	P	P	P	P
107	Pt100 2-wire in bearings.	NA	NA	NA	NA	NA	P	P	P	P	P	P	P	P	P
128	Double PT100, 2-wire in bearings	NA	NA	NA	NA	NA	P	P	P	P	P	P	P	P	P
129	Double PT100, 3-wire in bearings	NA	NA	NA	NA	NA	P	P	P	P	P	P	P	P	P
130	Pt100 3-wire in bearings.	NA	NA	NA	NA	NA	P	P	P	P	P	P	P	P	P
194	2Z bearings greased for life at both ends.	S	S	S	S	S	M	M	M	M	M	NA	NA	NA	NA
433	Outlet grease collector	NA	NA	NA	NA	NA	NA	NA	NA	NA	NA	P	P	P	P
506	Nipples for vibration measurement : SKF Marlin Quick Connect stud CMSS-2600-3	NA	NA	NA	NA	NA	P	P	P	P	P	P	P	P	P
654	Provision for vibration sensors (M8x1)	NA	NA	NA	NA	NA	P	P	P	P	P	P	P	P	P
795	Lubrication information plate	NA	NA	NA	NA	NA	M	M	M	M	M	S	S	S	S
796	Grease nipples JIS B 1575 PT 1/8 Type A	NA	NA	NA	NA	NA	P	P	P	P	P	P	P	P	P
797	Stainless steel SPM Nipples	NA	NA	NA	NA	NA	P	P	P	P	P	P	P	P	P
798	Stainless steel grease nipples	NA	NA	NA	NA	NA	P	P	P	P	P	P	P	P	P
799	Grease nipples flat type DIN 3404, thread M10x1	NA	NA	NA	NA	NA	M	M	M	M	M	M	P	P	P
800	Grease nipples JIS B 1575 PT 1/8" pin type	NA	NA	NA	NA	NA	P	P	P	P	P	P	P	P	P
Branch standard designs															
178	Stainless steel / acid proof bolts.	S	S	S	S	S	M	M	M	M	M	M	P	P	P
204	Jacking bolts for foot mounted motors.	NA	NA	NA	NA	NA	P	P	P	P	P	P	P	S	S
209	Non-standard voltage or frequency, (special winding).	P	P	P	P	P	P	P	P	P	P	P	P	P	P
396	Motor designed for ambient temperature -20°C to -40°C, with space heaters (code 450/451 must be added).	P	P	P	P	P	P	P	P	P	P	P	P	P	P
397	Motor designed for ambient temperature -40°C to -55°C, with space heaters (code 450/451 must be added).	P	P	P	P	P	P	P	P	P	P	P	P	P	P
398	Motor designed for ambient temperature -20°C to -40°C.	P	P	P	P	P	P	P	P	P	P	P	P	P	P
399	Motor designed for ambient temperature -40°C to -55°C.	P	P	P	P	P	P	P	P	P	P	P	P	P	P
425	Corrosion protected stator and rotor core.	S	S	S	S	S	S	S	S	S	S	P	P	P	P
786	Special design shaft upwards (V3, V36, V6) for outdoor mounting.	P	P	P	P	P	P	P	P	P	P	R	R	NA	NA

¹⁾ Certain variant codes cannot be used simultaneously.

S = Included as standard
P = New manufacture only
M = On modification of a stocked motor; or on new manufacture, the number of number per order may be limited.
R = On request
NA = Not applicable.

Code ¹⁾	Variant	Frame Size													
		80	90	100	112	132	160	180	200	225	250	280	315	355	400
Cooling system															
044	Unidirectional fan for reduced noise level. Rotation clockwise seen from D-end. Available only for 2-pole motors.	NA	NA	NA	NA	NA	NA	NA	NA	NA	NA	P	P	P	S
045	Unidirectional fan for reduced noise level. Rotation counter clockwise seen from D-end. Available only for 2-pole motors.	NA	NA	NA	NA	NA	NA	NA	NA	NA	NA	P	P	P	S
068	Light alloy metal fan	M	M	M	M	M	M	M	M	M	M	M	P	P	P
183	Separate motor cooling (fan axial, N-end).	NA	NA	NA	NA	NA	P	P	P	P	P	P	P	P	P
206	Steel fan	NA	NA	NA	NA	NA	P	P	P	P	P	P	P	P	P
422	Separate motor cooling (fan top, N-end).	NA	NA	NA	NA	NA	NA	NA	NA	NA	NA	P	P	P	P
791	Stainless steel fan cover	NA	NA	NA	NA	NA	NA	NA	NA	NA	P	P	P	P	P
Coupling															
035	Assembly of customer supplied coupling- half.	NA	NA	NA	NA	NA	NA	NA	NA	NA	NA	P	P	P	P
Documentation															
141	Binding dimension drawing.	M	M	M	M	M	M	M	M	M	M	M	P	P	P
Drain holes															
448	Draining holes with metal plugs.	NA	NA	NA	NA	NA	P	P	P	P	P	P	P	P	P
Earthing Bolt															
067	External earthing bolt.	S	S	S	S	S	S	S	S	S	S	S	S	S	S
Hazardous Environments															
452	DIP/Ex tD acc. to ATEX directive 94/9/EC , T= 125 °C, cat. 3D, IP55	M	M	M	M	M	NA	NA	M	M	M	M	P	P	P
453	DIP/Ex tD acc. to ATEX directive 94/9/EC , T= 125 °C, cat. 2D, IP65	M	M	M	M	M	M	M	M	M	M	M	P	P	P
454	DIP/Ex tD acc. to ATEX directive 94/9/EC , T= 125 °C, cat. 3D, IP65	M	M	M	M	M	NA	NA	M	M	M	M	P	P	P
461	Ex d(e) design, Group II C	M	M	M	M	M	M	M	M	M	M	P	P	P	P
462	Ex d(e) design, temperature class T5.	R	R	R	R	R	R	R	R	R	R	R	R	R	R
463	Ex d(e) design, temperature class T6.	R	R	R	R	R	R	R	R	R	R	NA	NA	NA	NA
464	Alleinschutz' design. Certification of flame proof motor and protection device together.	P	P	P	P	P	P	P	P	P	P	P	R	R	R
508	Exde from Exd.	NA	NA	NA	NA	NA	M	M	NA	NA	NA	NA	NA	NA	NA
812	Explosion protection according to IEC-standards.	M	M	M	M	M	M	M	M	M	M	M	P	P	P
813	Thermistor-based surface temperature protection T4 for frequency convertor duty.	M	M	M	M	M	M	M	M	M	M	M	P	P	P
814	Ex tD (DIP) motors, temperature class T 150C.	M	M	M	M	M	M	M	M	M	M	M	P	P	P
816	Pt-100-based surface temperature protection T4 for frequency convertor duty. 3-wire system.	NA	NA	NA	NA	NA	P	P	P	P	P	P	P	P	P
Heating elements															
450	Heating element, 100-120V.	M	M	M	M	M	M	M	M	M	M	M	P	P	P
451	Heating element, 200-240V.	M	M	M	M	M	M	M	M	M	M	M	P	P	P
Insulation system															
014	Winding insulation class H.	P	P	P	P	P	P	P	P	P	P	P	P	P	P
405	Special winding insulation for frequency converter supply.	P	P	P	P	P	P	P	P	P	P	P	P	P	P

¹⁾ Certain variant codes cannot be used simultaneously.

S = Included as standard

P = New manufacture only

M = On modification of a stocked motor; or on new manufacture,
the number of number per order may be limited.

R = On request

NA = Not applicable.

Code ¹⁾	Variant	Frame Size													
		80	90	100	112	132	160	180	200	225	250	280	315	355	400
Mounting arrangements															
007	IM 3001 flange mounted, IEC flange, from IM 1001 (B5 from B3).	M	M	M	M	M	NA	NA	NA	NA	NA	NA	NA	NA	NA
008	IM 2101 foot/flange mounted, IEC flange, from IM 1001 (B34 from B3).	M	M	M	M	M	NA	NA	NA	NA	NA	NA	NA	NA	NA
009	IM 2001 foot/flange mounted, IEC flange, from IM 1001 (B35 from B3).	M	M	M	M	M	M	M	M	M	M	M	P	P	P
047	IM 3601 flange mounted, IEC flange, from IM 3001 (B14 from B5).	M	M	M	M	M	NA	NA	NA	NA	NA	NA	NA	NA	NA
066	Modified for non-standard mounting position (please specify IM xxxx), (must be ordered for all mounting arrangements excluding IM B3 (1001), IM B5 (3001), IM B35 (2001), B34 (2101) & B14 (3601).	M	M	M	M	M	M	M	M	M	M	M	P	P	P
093	IM 3601 flange mounted, IEC flange, from IM 1001 (B14 from B3).	M	M	M	M	M	NA	NA	NA	NA	NA	NA	NA	NA	NA
228	Flange FF 130.	M	M	M	M	NA	NA	NA	NA	NA	NA	NA	NA	NA	NA
229	Flange FT 130.	M	M	M	M	NA	NA	NA	NA	NA	NA	NA	NA	NA	NA
235	Flange FF 165.	S	P	M	M	M	NA	NA	NA	NA	NA	NA	NA	NA	NA
236	Flange FT 165.	NA	M	M	M	M	NA	NA	NA	NA	NA	NA	NA	NA	NA
245	Flange FF 215.	NA	NA	S	S	M	NA	NA	NA	NA	NA	NA	NA	NA	NA
246	Flange FT 215.	NA	NA	M	M	M	NA	NA	NA	NA	NA	NA	NA	NA	NA
255	Flange FF 265.	NA	NA	NA	NA	S	NA	NA	NA	NA	NA	NA	NA	NA	NA
256	Flange FT 265.	NA	NA	NA	NA	M	NA	NA	NA	NA	NA	NA	NA	NA	NA
257	Flange FF 100.	M	NA	NA	NA	NA	NA	NA	NA	NA	NA	NA	NA	NA	NA
258	Flange FT 100.	M	NA	NA	NA	NA	NA	NA	NA	NA	NA	NA	NA	NA	NA
259	Flange FF 115.	M	M	NA	NA	NA	NA	NA	NA	NA	NA	NA	NA	NA	NA
260	Flange FT 115.	M	M	NA	NA	NA	NA	NA	NA	NA	NA	NA	NA	NA	NA
305	Additional lifting lugs.	NA	NA	NA	NA	NA	NA	NA	NA	NA	NA	P	P	P	P
309	IM 1001 foot mounted, from IM 3001 (B3 from B5).	M	M	M	M	M	M	M	NA	NA	NA	NA	NA	NA	NA
311	IM 2001 foot/flange mounted, IEC flange, from IM 3001 (B35 from B5).	M	M	M	M	M	NA	NA	NA	NA	NA	NA	NA	NA	NA
Painting															
111	Painting system C3M acc. to ISO 12944-5:2007	S	S	S	S	S	S	S	S	S	S	S	S	S	S
114	Special paint colour, standard grade.	M	M	M	M	M	M	M	M	M	M	M	P	P	P
115	Painting system C4M acc. to ISO 12944-5: 2007	P	P	P	P	P	P	P	P	P	P	P	P	P	P
168	Primer paint only.	P	P	P	P	P	P	P	P	P	P	P	P	P	P
754	Painting system C5M acc. to ISO 12944-5:2007	P	P	P	P	P	P	P	P	P	P	P	P	P	P
755	Aluminium metallizing and painting according to NORSOK M501 revision 5, Method 2A (only available color RAL 7038)	P	P	P	P	P	P	P	P	P	P	P	P	P	P
Protection															
005	Metal protective roof, vertical motor, shaft down.	M	M	M	M	M	M	M	M	M	M	M	P	P	P
072	Radial seal at D-end.	M	M	M	M	M	M	M	M	M	M	P	P	NA	NA
073	Sealed against oil at D-end.	P	P	P	P	P	P	P	P	P	P	P	P	P	P

¹⁾ Certain variant codes cannot be used simultaneously.

S = Included as standard
P = New manufacture only
M = On modification of a stocked motor; or on new manufacture, the number of number per order may be limited.
R = On request
NA = Not applicable.

Code ¹⁾	Variant	Frame Size													
		80	90	100	112	132	160	180	200	225	250	280	315	355	400
158	Degree of protection IP65.	M	M	M	M	M	M	M	M	M	M	M	P	P	P
401	Protective roof, horizontal motor.	P	P	P	P	P	P	P	P	P	P	P	P	P	P
403	Degree of protection IP56.	M	M	M	M	M	M	M	M	M	M	M	P	P	P
434	Degree of protection IP56, open deck.	NA	NA	NA	NA	NA	P	P	P	P	P	P	P	P	P
783	Labyrinth sealing at D-end.	P	P	P	P	P	P	P	P	P	P	P	P	S	S
Rating & instruction plates															
002	Restamping voltage, frequency and output, continuous duty.	M	M	M	M	M	M	M	M	M	M	M	P	P	P
004	Additional text on std rating plate (max 12 digits on free text line).	P	P	P	P	P	P	P	P	P	P	P	P	P	P
095	Restamping output (maintained voltage, frequency), intermittent duty.	M	M	M	M	M	M	M	M	M	M	M	P	P	P
126	Tag plate	P	P	P	P	P	P	P	P	P	P	P	P	P	P
135	Mounting of additional identification plate, stainless.	M	M	M	M	M	M	M	M	M	M	M	P	P	P
139	Additional identification plate delivered loose.	M	M	M	M	M	M	M	M	M	M	M	P	P	P
161	Additional rating plate delivered loose.	M	M	M	M	M	M	M	M	M	M	M	P	P	P
163	Frequency converter rating plate. Rating data according to quotation.	M	M	M	M	M	M	M	M	M	M	M	P	P	P
Shaft & rotor															
069	Two shaft extensions as per basic catalogue.	P	P	P	P	P	P	P	P	P	P	P	P	P	P
070	One or two special shaft extensions, standard shaft material.	P	P	P	P	P	P	P	P	P	P	P	P	P	P
164	Shaft extension with closed key-way.	S	S	S	S	S	S	S	S	S	S	P	P	P	P
165	Shaft extension with open key-way.	P	P	P	P	P	P	P	P	P	P	S	S	S	S
410	Stainless steel shaft (standard or non-standard design).	R	R	R	R	R	R	R	R	R	R	P	P	P	P
Standards and Regulations															
151	Design according to SHELL DEP 33.66.05.31-Gen. June 2007	M	M	M	M	M	M	M	M	M	M	P	P	P	P
540	China energy label	M	M	M	M	M	M	M	M	M	M	M	M	M	NA
774	Design according to NORSOK (Norwegian Territorial Waters)excluding surface treatment.	P	P	P	P	P	P	P	P	P	P	P	P	P	P
775	Design according to SHELL DEP 33.66.05.31-Gen. January 1999 design.	M	M	M	M	M	M	M	M	M	M	M	P	P	P
778	GOST Export/Import Certificate (Russia).	P	P	P	P	P	P	P	P	P	P	M	P	P	P
779	SASO Export/Import Certificate (Saudi Arabia)	M	M	M	M	M	M	M	M	M	M	M	P	P	P
782	Fulfilling CQST Certification requirements (China)	M	M	M	M	M	M	M	M	M	M	M	P	P	P
788	Documentation for Korean KOSHA certification (must be ordered with variant code 812)	M	M	M	M	M	M	M	M	M	M	M	P	P	P
802	GOST Kazakhstan certified	P	P	P	P	P	P	P	P	P	P	P	P	P	NA
Stator winding temperature sensors															
120	KTY 84-130 (1 per phase) in stator winding.	P	P	P	P	P	P	P	P	P	P	P	P	P	P
121	Bimetal detectors, break type (NCC), (3 in series), 130°C, in stator winding.	P	P	P	P	P	P	P	P	P	P	P	P	P	P
122	Bimetal detectors, break type (NCC), (3 in series), 150°C, in stator winding.	P	P	P	P	P	P	P	P	P	P	P	P	P	P

¹⁾ Certain variant codes cannot be used simultaneously.

S = Included as standard
P = New manufacture only
M = On modification of a stocked motor; or on new manufacture, the number of number per order may be limited.
R = On request
NA = Not applicable.

Code ¹⁾	Variant	Frame Size													
		80	90	100	112	132	160	180	200	225	250	280	315	355	400
123	Bimetal detectors, break type (NCC), (3 in series), 170°C, in stator winding.	NA	NA	NA	NA	NA	NA	NA	NA	NA	NA	P	P	P	P
125	Bimetal detectors, break type (NCC), (2x3 in series), 150°C, in stator winding.	P	P	P	P	P	P	P	P	P	P	P	P	P	P
127	Bimetal detectors, break type (NCC), (3 in series, 130°C & 3 in series, 150°C), in stator winding.	P	P	P	P	P	P	P	P	P	P	P	P	P	P
328	PTC - thermistors (3 in series), 120°C, in stator winding	M	M	M	M	M	M	M	M	M	M	M	P	P	P
435	PTC - thermistors (3 in series), 130°C, in stator winding.	M	M	M	M	M	M	M	M	M	M	M	P	P	P
436	PTC - thermistors (3 in series), 150°C, in stator winding.	S	S	S	S	S	S	S	S	S	S	S	S	S	S
439	PTC - thermistors (2x3 in series), 150°C, in stator winding.	M	M	M	M	M	M	M	M	M	M	M	P	P	P
441	PTC - thermistors (3 in series, 130°C & 3 in series, 150°C), in stator winding.	M	M	M	M	M	M	M	M	M	M	M	P	P	P
445	Pt-100 2-wire in stator winding, 1 per phase	NA	NA	NA	NA	NA	P	P	P	P	P	P	P	P	P
446	Pt-100 2-wire in stator winding, 2 per phase	NA	NA	NA	NA	NA	P	P	P	P	P	P	P	P	P
502	Pt-100 3-wire in stator winding, 1 per phase.	NA	NA	NA	NA	NA	P	P	P	P	P	P	P	P	P
503	Pt-100 3-wire in stator winding, 2 per phase.	NA	NA	NA	NA	NA	P	P	P	P	P	P	P	P	P
Terminal box															
021	Terminal box LHS (seen from D-end).	NA	NA	NA	NA	NA	P	P	NA	NA	NA	NA	NA	NA	NA
022	Cable entry LHS (seen from D-end).	M	M	M	M	M	M	M	M	M	M	M	P	P	P
157	Terminal box degree of protection IP65.	M	M	M	M	M	M	M	M	M	M	M	P	P	P
180	Terminal box RHS (seen from D-end).	NA	NA	NA	NA	NA	P	P	NA	NA	NA	NA	NA	NA	NA
300	Increased single core cross section	P	P	P	P	P	P	P	P	P	P	P	P	P	P
380	Separate terminal box for temperature detectors, std. material	NA	NA	NA	NA	NA	P	P	P	P	P	P	P	P	P
400	4 x 90 degr turnable terminal box.	S	S	S	S	S	S	S	S	S	S	S	S	NA	NA
402	Terminal box adapted for Al cables.	NA	NA	NA	NA	NA	NA	NA	NA	NA	NA	S	S	S	S
418	Separate terminal box for auxiliaries, standard material.	NA	NA	NA	NA	NA	P	P	P	P	P	P	P	P	P
466	Terminal box at N-end.	NA	NA	NA	NA	NA	NA	NA	P	P	P	P	P	P	P
468	Cable entry from D-end.	M	M	M	M	M	M	M	M	M	M	M	P	P	P
469	Cable entry from N-end.	M	M	M	M	M	M	M	M	M	M	M	P	P	P
567	Separate terminal box material: Cast Iron	NA	NA	NA	NA	NA	S	S	S	S	S	S	S	S	S
568	Separate terminal box for heating elements, std. material	NA	NA	NA	NA	NA	P	P	P	P	P	P	P	P	P
569	Separate terminal box for brakes	NA	NA	NA	NA	NA	P	P	P	P	P	NA	NA	NA	NA
728	Standard cable gland, Ex d IIB, armoured cable, double sealing.	P	P	P	P	P	P	P	P	P	P	P	P	P	P
730	Prepared for NPT cable glands	P	P	P	P	P	P	P	P	P	P	P	P	P	P
732	Standard cable gland, Ex d IIB, armoured cable.	M	M	M	M	M	M	M	M	M	M	M	P	P	P
733	Standard cable gland, Ex d IIB, non-armoured cable.	M	M	M	M	M	M	M	M	M	M	M	P	P	P
734	Standard cable gland, Ex d IIC, armoured cable.	M	M	M	M	M	M	M	M	M	M	M	P	P	P
735	Standard cable gland, Ex d IIC, non-armoured cable.	M	M	M	M	M	M	M	M	M	M	M	P	P	P

¹⁾ Certain variant codes cannot be used simultaneously.

S = Included as standard
P = New manufacture only
M = On modification of a stocked motor; or on new manufacture, the number of number per order may be limited.
R = On request
NA = Not applicable.

Code ¹⁾	Variant	Frame Size														
		80	90	100	112	132	160	180	200	225	250	280	315	355	400	
Testing																
145	Type test report from a catalogue motor, 400V 50Hz.	M	M	M	M	M	M	M	M	M	M	M	P	P	P	
146	Type test with report for one motor from specific delivery batch.	P	P	P	P	P	P	P	P	P	P	P	P	P	P	
148	Routine test report.	M	M	M	M	M	M	M	M	M	M	M	P	P	P	
150	Customer witnessed testing. Specify test procedure with other codes.	P	P	P	P	P	P	P	P	P	P	P	P	P	P	
222	Torque/speed curve, type test and multi-point load test with report for one motor from specific delivery batch.	P	P	P	P	P	P	P	P	P	P	P	P	P	P	
760	Vibration level test	M	M	M	M	M	M	M	M	M	M	M	P	P	P	
761	Vibration spectrum test for one motor from specific delivery batch.	P	P	P	P	P	P	P	P	P	P	P	P	P	P	
762	Noise level test for one motor from specific delivery batch.	P	P	P	P	P	P	P	P	P	P	P	P	P	P	
763	Noise spectrum test for one motor from specific delivery batch.	P	P	P	P	P	P	P	P	P	P	P	P	P	P	
764	Test for one motor from specific delivery batch with ABB frequency converter available at ABB test field. ABB standard test procedure.	P	P	P	P	P	P	P	P	P	P	P	P	P	P	
Variable speed drives																
181	Rating plate with ABB standard loadability values for VSD operation. Other auxiliaries for VSD operation to be selected as necessary.	M	M	M	M	M	M	M	M	M	M	M	P	P	P	P
479	Mounting of other type of pulse tacho with shaft extension, tacho not included.	NA	NA	NA	NA	NA	P	P	P	P	P	P	P	P	P	
680	2048 pulse tacho, Ex d, tD, L&L 841910001	NA	NA	NA	NA	NA	P	P	P	P	P	P	P	P	P	
701	Insulated bearing at N-end.	NA	NA	NA	NA	NA	NA	NA	NA	NA	NA	M	P	P	P	
747	1024 pulse tacho, Ex d, tD, L&L 841910002	NA	NA	NA	NA	NA	P	P	P	P	P	P	P	P	P	
Y/Δ starting																
117	Terminals for Y/Δ start at both speeds (two speed windings).	NA	NA	NA	NA	NA	R	R	R	R	R	P	P	R	R	
118	Terminals for Y/Δ start at high speed (two speed windings).	NA	NA	NA	NA	NA	R	R	R	R	R	P	P	R	R	
119	Terminals for Y/Δ start at low speed (two speed windings).	NA	NA	NA	NA	NA	R	R	R	R	R	P	P	R	R	

¹⁾ Certain variant codes cannot be used simultaneously.

S = Included as standard
P = New manufacture only
M = On modification of a stocked motor; or on new manufacture, the number of number per order may be limited.
R = On request
NA = Not applicable.

Flameproof motors

Dimension drawings, Ex d

Foot-mounted motor IM 1001, IM B3

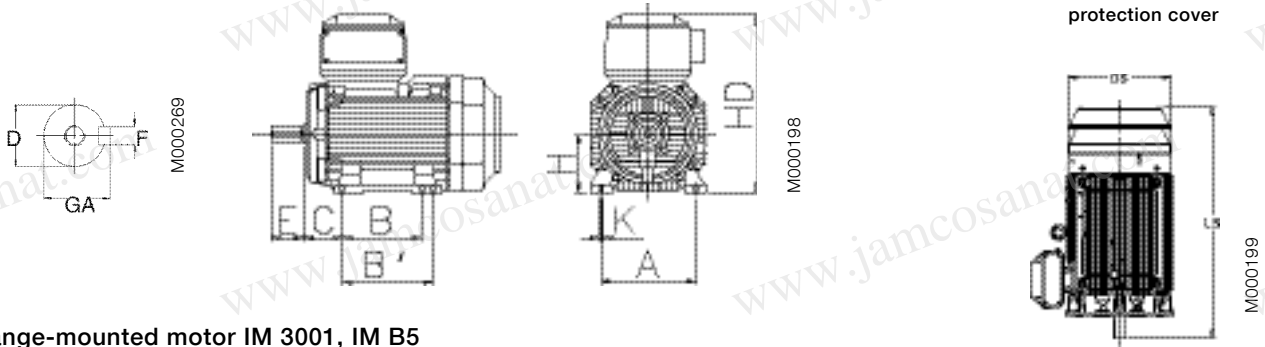

Flange-mounted motor IM 3001, IM B5

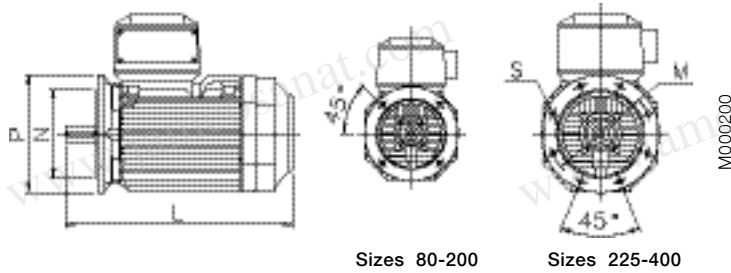

Motor size	IM 1001. IM B3 AND IM 3001. IM B5								IM 1001. IM B3					IM 3001. IM B5				Protective roof							
	D poles		GA poles		F poles		E poles		L max poles		O	A	B	B'	C	HD	K	H	M	N	P	S	DS	LS poles	
	2	4-8	2	4-8	2	4-8	2	4-8	2	4-8					M3JP							2	4-8		
80	19	19	21.5	21.5	6	6	40	40	340	340	20	125	100	125	50	290	10	80	165	130	200	12	160	360	360
90	24	24	27	27	8	8	50	50	405	405	20	140	100	125	56	315	10	90	165	130	200	12	180	430	430
100	28	28	31	31	8	8	60	60	520	520	25	160	140	-	63	335	10	100	215	180	250	14.5	195	505	505
112	28	28	31	31	8	8	60	60	520	520	25	190	140	-	70	350	12	112	215	180	250	14.5	195	505	505
132	38	38	41	41	10	10	80	80	580	580	30	216	140	178	89	390	12	132	265	230	300	14.5	260	590	590
160	42	42	45	45	12	12	110	110	808	808	45	254	210	254	108	495	14.5	160	300	250	350	18.5	328	756	756
180	48	48	51.5	51.5	14	14	110	110	826	826	50	279	241	279	121	535	14.5	180	300	250	350	18.5	359	756	756
200	55	55	59	59	16	16	110	110	774	774	70	318	267	305	133	616	18.5	200	350	300	400	18.5	414	844	844
225	55	60	59	64	16	18	110	140	841	871	80	356	286	311	149	663	18.5	225	400	350	450	18.5	462	921	951
250	60	65	64	69	18	18	140	140	875	875	90	406	311	349	168	726	24	250	500	450	550	18.5	506	965	965
280	65	75	69	79.5	18	20	140	140	1090	1090	100	457	368	419	190	862	24	280	500	450	550	18	555	1190	1190
315 SM	65	80	69	85	18	22	140	170	1176	1206	115	508	406	457	216	929	30	315	600	550	660	23	624	1290	1320
315 ML	65	90	69	95	18	25	140	170	1287	1317	115	508	457	508	216	929	30	315	600	550	660	23	624	1401	1431
355 SM	70	100	74.5	106	20	28	140	210	1409	1479	130	610	500	560	254	1124	35	355	740	680	800	23	590	1480	1550
355 ML	70	100	74.5	106	20	28	140	210	1514	1584	130	610	560	630	254	1124	35	355	740	680	800	23	590	1530	1600
355 LK	70	100	74.5	106	20	28	140	210	1764	1834	130	610	630	710	254	1124	35	355	740	680	800	23	590	1635	1705
400 L	80	110	85	126	22	28	170	210	1851	1891	150	710	900	800	224	1211	35	400	940	880	1000	28	590	1635	1705
400 LK	80	100	85	106	22	28	170	210	1851	1891	150	686	710	800	280	1211	35	400	740	680	800	23	700	1860	1900

IM 3601, IM B14 - Available flange alternatives ; see also variant codes.

Flange size	Variant code	Flange dimensions P	Motor size M3JP									
			M	N	S	80	90	100	112	132		
FT100	258	120	100	80	M6	S	NA	NA	NA	NA	NA	S = Standard flange
FT115	260	140	115	95	M8	M	S	NA	NA	NA	NA	M = Option
FT130	229	160	130	110	M8	M	M	S	S	NA	NA	NA = Not possible
FT165	236	200	165	130	M10	NA	NA	NA	NA	S		
FT215	246	250	215	180	M12	NA	M	M	R	R		
FT265	256	300	265	230	M12	NA	NA	NA	NA	M		
FT100	257	120	100	80	M7	S	M	NA	NA	NA		
FT115	259	140	115	95	M10	M	S	NA	NA	NA		
FT130	228	160	130	110	M10	M	M	S	S	NA		
FT165	235	200	165	130	M12	M	M	M	M	S		
FT215	245	250	215	180	M14.5	NA	NA	M	M	M		
FT265	255	300	265	230	M14.5	NA	NA	NA	NA	M		

Tolerances:

A, B	± 0,8
D, DA	ISO k6 < Ø 50mm
	ISO m6 > Ø 50mm
F, FA	ISO h9
H	+0 -0,5
N	ISO j6
C, CA	± 0,8

Above table gives the main dimensions in mm. For detailed drawings please see our web-pages www.abb.com/motors&generators or contact ABB.

Flameproof motor construction Ex d

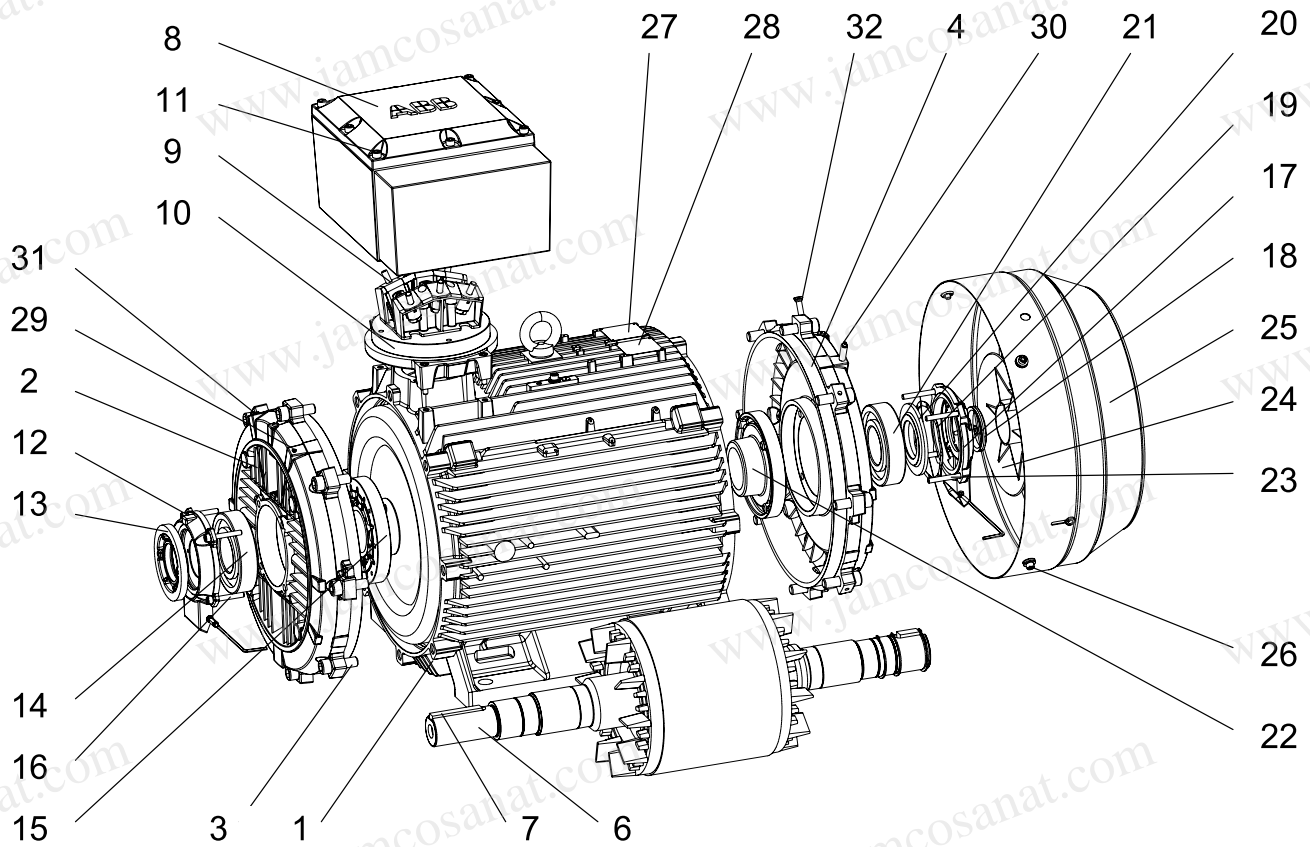

- | | | | |
|----|---------------------------------------|----|--|
| 1 | Stator frame | 17 | Outer bearing cover, N-end |
| 2 | Endshield, D-end | 18 | Seal, N-end |
| 3 | Screws for endshield, D-end | 19 | Wave spring (280-315)
Coil spring (355-400) |
| 4 | Endshield, N-end | 20 | Valve disc, N-end |
| 5 | Screws for endshield, N-end | 21 | Bearing, N-end |
| 6 | Rotor with shaft | 22 | Inner bearing cover, N-end |
| 7 | Key, D-end | 23 | Screws for bearing cover, N-end |
| 8 | Terminal box | 24 | Fan |
| 9 | Terminal board | 25 | Fan cover |
| 10 | Intermediate flange | 26 | Screws for fan cover |
| 11 | Screws for terminal box cover | 27 | Rating plate |
| 12 | Outer bearing cover, D-end | 28 | Regreasing plate |
| 13 | Valve disc with labyrinth seal, D-end | 29 | Grease nipple, D-end |
| 14 | Bearing, D-end | 30 | Grease nipple, N-end |
| 15 | Inner bearing cover, D-end | 31 | SPM nipple, D-end |
| 16 | Screws for bearing cover, D-end | 32 | SPM nipple, N-end |

M000207

Certificate examples



IECEx Certificate of Conformity

INTERNATIONAL ELECTROTECHNICAL COMMISSION
IEC Certification Scheme for Explosive Atmospheres



For rules and details of the IECEx Scheme visit www.iecex.com

Certificate No.:	IECEx LCI 09.0008X	Issue No.1:	Certificate history: Issue No. 1 (2009-3-19) Issue No. 0 (2009-2-23)
Status:	Current		
Date of Issue:	2009-03-19	Page 1 of 5	
Applicant:	ABB Oy Motors Strombergin Puistitie 5A FIN - 65101 VAASA - Finland		
Electrical Apparatus: Optional accessory:	Asynchronous motor - M3JPK/PJOKC 160 ... (Generation H)		
Type of Protection:	d or de and/or ID		
Marking:	Ex dIle IIB/C T3 to T6 Ex ID A21 T85°C to T150°C		
Approved for issue on behalf of the IECEx Certification Body:	Marc GILLAUX  Ex Certification Manager Date: 28.04.2009		
Position:	Ex Certification Manager		
Signature: (for printed version)	Marc GILLAUX		
Date:	28.04.2009		

1. This certificate and schedule may only be reproduced in full.
2. This certificate is not transferable and remains the property of the issuing body.
3. The status and authenticity of this certificate may be verified by visiting the Official IECEx Website.

Certificate issued by:
 Laboratoire Central des Industries Electriques (LCIE)
 33 Avenue du General Leclerc
 FR-92260 Fontenay-aux-Roses
 France

M000726

<p>1 ATTESTATION D'EXAMEN CE DE TYPE</p> <p>2 Appareil ou système de protection destiné à être utilisé en atmosphères explosives (Directive 94/9/CE)</p> <p>3 Numéro de l'attestation d'examen CE de type LCIE 09 ATEX 3004 X</p> <p>4 Appareil ou système de protection : Type : M3JP160 ..., M3KP160 ..., M3JC160 ..., M3KC160 ... (Génération H)</p> <p>5 Demandeur : ABB Oy Motors Strombergin Puistitie 5A FIN - 65101 VAASA - Finland</p> <p>6 Fabricant : ABB Oy Motors Strombergin Puistitie 5A FIN - 65101 VAASA - Finland</p> <p>7 Cet appareil ou système de protection et ses variantes éventuelles acceptées sont décrits dans l'annexe de la présente attestation et dans les documents descriptifs cités en référence.</p> <p>8 La LCIE, organisme notifié sous la référence 0081 conformément à l'article 9 de la directive 94/9/CE du Parlement européen et du Conseil du 23 mars 1994, certifie que cet appareil ou système de protection est conforme aux exigences essentielles de sécurité et de santé pour la conception et la construction d'appareils et de systèmes de protection destinés à être utilisés en atmosphères explosives, données dans l'annexe II de la directive. Les résultats des vérifications et essais figurent dans le rapport confidentiel N° 86287-571197-01.</p> <p>9 Le respect des exigences essentielles de sécurité et de santé est assuré par la conformité à : - EN 60079-0 (2006) - EN 61241-0 (2006) - EN 60079-1 (2007) - EN 61241-1 (2004) - EN 60079-7 (2007)</p> <p>10 Le signe X lorsqu'il est placé à la suite du numéro de l'attestation, indique que cet appareil ou système de protection est soumis aux conditions spéciales pour une utilisation sûre, mentionnées dans l'annexe de la présente attestation.</p> <p>11 Cette attestation d'examen CE de type concerne uniquement la conception et la construction de l'appareil ou du système de protection spécifiés, conformément à l'annexe III de la directive 94/9/CE. Des exigences supplémentaires de la directive sont applicables pour la fabrication et la fourniture de l'appareil ou du système de protection. Ces dernières ne sont pas couvertes par la présente attestation.</p> <p>12 Le marquage de l'appareil ou du système de protection doit comporter les informations détaillées au point 15.</p>	<p>1 EC TYPE EXAMINATION CERTIFICATE</p> <p>2 Equipment or protective system intended for use in potentially explosive atmospheres (Directive 94/9/EC)</p> <p>3 EC type examination certificate number LCIE 09 ATEX 3004 X</p> <p>4 Equipment or protective system : Type : M3JP160 ..., M3KP160 ..., M3JC160 ..., M3KC160 ... (Generation H)</p> <p>5 Applicant : ABB Oy Motors Strombergin Puistitie 5A FIN - 65101 VAASA - Finland</p> <p>6 Manufacturer : ABB Oy Motors Strombergin Puistitie 5A FIN - 65101 VAASA - Finland</p> <p>7 This equipment or protective system and any acceptable variation thereto are specified in the schedule to this certificate and the documents therein referred to.</p> <p>8 LCIE, notified body number 0081 in accordance with article 9 of the Directive 94/9/EC of the European Parliament and the Council of 23 March 1994, certifies that this equipment or protective system has been found to comply with the essential Health and Safety Requirements relating to the design and construction of apparatus and protective systems intended for use in potentially explosive atmospheres, given in Annex II to the Directive. The examination and test results are recorded in confidential report N° 86287-571197-01.</p> <p>9 Compliance with the Essential Health and Safety Requirements has been assured by compliance with : - EN 60079-0 (2006) - EN 61241-0 (2006) - EN 60079-1 (2007) - EN 61241-1 (2004) - EN 60079-7 (2007)</p> <p>10 If the sign X is placed after the certificate number, it indicates that the equipment or protective system is subject to special conditions for safe use specified in the schedule to this certificate.</p> <p>11 This EC type examination certificate relates only to the design and construction of this specified equipment or protective system in accordance with annex III to the directive 94/9/EC. Further requirements of the directive apply to the manufacturing process and supply of this equipment or protective system. These are not covered by this certificate.</p> <p>12 The marking of the equipment or protective system shall include information as detailed at 15.</p>
---	---

Fontenay-aux-Roses, le 23 février 2009

 Marc GILLAUX
 responsable de certification ATEX
 ATEX certification manager

Seul le texte en français peut engager la responsabilité de la LCIE. Ce document ne peut être traduit, sans autorisation préalable.
 The LCIE's liability applies only on the French text. This document may only be reproduced, without prior written permission, in any other language.

M000727



EC Declaration of Conformity

The Manufacturer: ABB Oy Motors
P.O. Box 633
Strombergin puistitie 5A
FIN - 65101 Vaasa, Finland

hereby declares that

the products: 3-phase induction motors, series M2GP, M3JP, M3JC, M3KP, M3KC, M3GP, M3HP and M3LP, as listed on page 2 in this document, fulfill provisions of the relevant Council Directives.

Directive 94/9/EC (ATEX of 23rd March 1994)

by applying the following harmonized standards:
EN 60079-0 (2006), EN 60079-1 (2007), EN 60079-7 (2007), EN 60079-15 (2005), EN 61241-0 (2006), EN 61241-1 (2004).

ABB Oy Motors declare on it's sole responsibility,
- that the state of the art of these standards do not modify the result of the assessment carried out by LCIE which issued the EC type examination certificates according to former editions of the standard series.
- that listed motors conform to the requirements of annex II of the directive 94/9/EC clause 1.2.7 by applying the standards serie EN 60034.

Directive 2005/32/EC (EuP of 6th July 2005)

by fulfilling the requirements of the standard EN 60034-30 (March 2009) in respect of the efficiency class.

Note: When installing motors for converter supply applications additional requirements must be respected regarding the motor as well as the installation, as described in the appropriate dedicated addendum.

Signed by: 
Jouni Ikaheimo
Product Development Manager

Date: April 29th, 2010 3GZF500930-988

ABB Oy

Motors Postal address P.O. Box 633 FI-65101 Vaasa FINLAND	Visiting Address Strombergin Puistitie 5 A FI-65320 Vaasa FINLAND	Telephone +358 10 22 11 Telefax +358 10 22 47372	Internet www.abb.fi e-mail: first name.last name @fi.abb.com	Business Identity Code: 0763403-0 Domicile: Helsinki
---	--	---	--	--

M000725-1



2(2)
2010-04-29

Certificates: 3-phase induction motors, series M2GP, M3JP, M3KP, M3GP, M3HP, M3LP

Group & category, IEC frame size, protection	Motor type	Certification number	Year of EC-marking	
Flameproof II 2 G Ex d I B / II C T1-T6 II 2 G Ex de II B / II C T1-T6	M3JPM3KP 80	LCIE 04 ATEX 8150	2004	
	M3JPM3KP 90	LCIE 04 ATEX 8151	2004	
	M3JPM3KP 100-112	LCIE 04 ATEX 8152	2004	
	M3JPM3KP 132	LCIE 04 ATEX 8081	2004	
	M3JPM3KP 160	LCIE 00 ATEX 8023	2000	
	M3JPM3KP 180	LCIE 00 ATEX 8028	2000	
	M3JPM3KP 180 Gen.H	LCIE 09 ATEX 3004X	2009	
	M3JPM3KP 200	LCIE 00 ATEX 8027	2000	
	M3JPM3KP 225	LCIE 00 ATEX 8029	2000	
	M3JPM3KP 250	LCIE 01 ATEX 8030	2001	
	M3JPM3KP 280	LCIE 01 ATEX 8078	2001	
	M3JPM3KP 315	LCIE 01 ATEX 8079	2001	
Increased safety II 2 G Ex e II T2-T3 In addition for M3HP160 - 400: II 2 D Ex ID A21	M3HP 90-90	LCIE 08 ATEX 8047	2008	
	M3HP 100-112	LCIE 08 ATEX 8048	2008	
	M3HP 132	LCIE 08 ATEX 8049	2008	
	M3HP 160	LCIE 01 ATEX 8015	2001	
	M3HP 180	LCIE 01 ATEX 8021	2001	
	M3HP 180 Gen.H	LCIE 09 ATEX 3022	2009	
	M3HP 180 Gen.H	LCIE 09 ATEX 3023	2009	
	M3HP 200	LCIE 01 ATEX 8022	2001	
	M3HP 225	LCIE 01 ATEX 8023	2001	
	M3HP 250	LCIE 01 ATEX 8024	2001	
	M3HP 280	LCIE 02 ATEX 8071	2002	
	M3HP 315	LCIE 02 ATEX 8072	2002	
Non-sparking II 3 G Ex nA II T2 - T3	M3GP 355	LCIE 03 ATEX 8022	2003	
	M3HP 400	LCIE 04 ATEX 8013	2004	
	M3GP 71-250	LCIE 08 ATEX 8160	2008	
	M3GP 80 - 400	LCIE 08 ATEX 8088	2008	
	M3GP 160 - 180 Gen.H	LCIE 09 ATEX 1010 *	2009	
	M3GPM3LP 450	LCIE 08 ATEX 8088	2008	
	Dust ignition II 2 D Ex ID A21 IP 65	M3GP 160 - 180 Gen.H	LCIE 09 ATEX 3016	2009
		M3GP 180 - 180 Gen.H	LCIE 09 ATEX 1010 *	2009
	Dust ignition II 3 D Ex ID A22	M3GP 160 - 180 Gen.H	LCIE 09 ATEX 1010 *	2009
		M3GPM3LP 450	LCIE 08 ATEX 8088	2008
	Dust ignition II 2 D Ex ID A21 IP 65 or II 3 D Ex ID A22 IP 55, IP65	M2GP 71-250	LCIE 05 ATEX 8160	2005
		M3GP 80-400	LCIE 08 ATEX 8088	2008

1) Notified Body (EXNB) LCIE (0081) : Av. Du Général Leclerc, 33, 92266 Fontenay-aux-Roses, France
2) *) Voluntary Type Examination Certificate for equipment category 3

3GZF500930-988

M000725-2

Flameproof motors Ex d in brief, basic design

Motor size		80	90	100	112	132	160	180	
Stator	Material	Cast iron, at least EN-GJL-200							
	Paint colour shade	Blue, Munsell 8B 4.5/3.25 (» NCS 4822-B05G)							
	Corrosion class	C3 medium according to ISO/EN 12944-5							
Bearing end shields	Material	Cast iron, at least EN-GJL-200							
	Paint colour shade	Blue, Munsell 8B 4.5/3.25 (» NCS 4822-B05G)							
	Corrosion class	C3 medium according to ISO/EN 12944-5							
Bearings	D-end 2-12 -pole	6205-2Z/C3	6205-2Z/C3	6206-2Z/C3	6206-2Z/C3	6208-2Z/C3	6309/C3	6310/C3	
	N-end 2-12 -pole	6204-2Z/C3	6205-2Z/C3	6206-2Z/C3	6206-2Z/C3	6208-2Z/C3	6309/C3	6309/C3	
Axially-locked bearings	Inner bearing cover	As standard, locked at D-end							
Bearing seal		Gamma ring							
Lubrication		Permanent grease lubrication						Regreasable bearings	
SPM-nipples		–						As standard	
Rating plate	Material	Stainless steel							
Terminal box	Frame material	Cast iron, at least EN-GJL-200							
	Cover material	Cast iron, at least EN-GJL-200							
	Cover screws material	Acidproof steel A4-80						Steel 8.8, zinc electroplated and chromated	
Connections	Cable entries	1xM25x1.5			1xM32x1.5		2xM40x1.5		
	Terminals	6 terminals for connection with cable lugs (not included)							
Fan	Material	Polyamide. Reinforced with glass fibre.						Polypropylene. Reinforced with glass fibre.	
Fan cover	Material	Steel						Hot dip galvanized steel	
	Paint colour shade	Blue, Munsell 8B 4.5/3.25 (» NCS 4822-B05G)							
	Corrosion class	C3 medium according to ISO/EN 12944-5							
Stator winding	Material	Copper							
	Insulation	Insulation class F							
	Winding protection	3 pcs thermistors as standard							
Rotor winding	Material	Pressure die-cast aluminum							
Balancing		Half key balancing							
Key way		Closed							
Heating elements	On request	25 W							
Drain holes		–						Optional	
External earthing bolt		As standard							
Enclosure		IP 55							
Cooling method		IC 411							

Flameproof motors Ex d in brief, basic design

Motor size		200	225	250	280	315	355	400	
Stator	Material	Cast iron, at least EN-GJL-200							
	Paint colour shade	Blue, Munsell 8B 4.5/3.25 (→ NCS 4822-B05G)							
	Corrosion class	C3 medium according to ISO/EN 12944-5							
Bearing end shields	Material	Cast iron, at least EN-GJL-200							
	Paint colour shade	Blue, Munsell 8B 4.5/3.25 (→ NCS 4822-B05G)							
	Corrosion class	C3 medium according to ISO/EN 12944-5							
Bearings	D-end	2-pole	6312M/C3	6313M/C3	6315M/C3	6316/C3	6316/C3	6316M/C3	6317M/C3
		4-12 -pole	6312/C3	6313/C3	6315/C3	6316/C3	6319/C3	6322/C3	6324/C3
	N-end	2-pole	6310M/C3	6312M/C3	6313M/C3	6316/C3	6316/C3	6316M/C3	6317M/C3
		4-12 -pole	6310/C3	6312/C3	6313/C3	6316/C3	6316/C3	6316/C3	6319/C3
Axially-locked bearings	Inner bearing cover	As standard, locked at D-end							
Bearing seal		Gamma-ring				Labyrinth seal			
Lubrication		Regreasable bearings							
SPM-nipples		As standard							
Rating plate	Material	Stainless steel							
Terminal box	Frame material	Cast iron, at least EN-GJL-200							
	Cover material	Cast iron, at least EN-GJL-200							
	Cover screws material	Steel 8.8, zinc electroplated and chromated							
Connections	Cable entries	2xM50x1.5			2xM63x1.5	2xM75x1.5			
	Terminals	6 terminals for connection with cable lugs (not included)							
Fan	Material	Polypropylene. Reinforced with glass fibre.					Polypropylene. Reinforced with glass fibre. or aluminum.		
Fan cover	Material	Hot dip galvanized steel							
	Paint colour shade	Blue, Munsell 8B 4.5/3.25 (→ NCS 4822-B05G)							
	Corrosion class	C3 medium according to ISO/EN 12944-5							
Stator winding	Material	Copper							
	Insulation	Insulation class F							
	Winding protection	3 pcs thermistors as standard							
Rotor winding	Material	Pressure die-cast aluminum							
Balancing method		Half key balancing							
Key way		Closed				Open			
Heating elements	On request	25 W	60 W			120 W			
Drain holes		Optional							
External earthing bolt		As standard							
Enclosure		IP 55							
Cooling method		IC 411							

Flameproof motors, Ex de IIB/IIC T4 Totally enclosed squirrel cage three phase low voltage motors, Sizes 80 - 400, 0.55 to 710 kW



www.abb.com/motors&generators

- > Motors for explosive atmospheres
- >> Flameproof motors



Mechanical design

Drain holes

Flameproof Ex de motors are provided without drain holes as standard.

Drain holes with certified metal plugs are available as an option. Please see variant code section.

Type of protection	Frame material	Frame size	Drain holes
Flameproof	Cast iron	80-400 160-400	not included optional

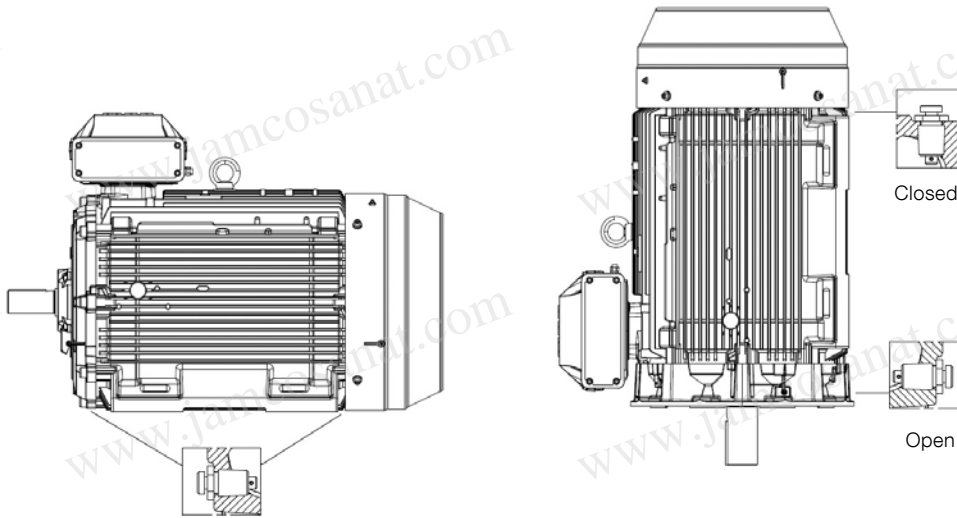

M000724

Terminal box standard delivery

Terminal boxes are mounted on top of the motor at D-end as standard. The terminal boxes of motor sizes 80-355 can be turned 4x90° and in motor sizes 400 2x180° after delivery. When ordering Ex de motors in sizes 280-400 with 4x90°, the position of the terminal box has to be defined in the order.

The degree of protection of standard terminal and it complies with the requirements of this enclosure type and effectively prevents all ignition sources such as sparks, excessive overheating etc. The features of the terminal box are : no selfloosening terminals, compliance with creepage distances and clearances specified in standards.

If no ordering information on the cable is given, it is assumed to be p.v.c. -insulated non-armoured and termination parts are supplied according to the table on the following pages.

To enable the supply of suitable terminations for the motor, please state cable type, quantity, size and outer diameter when ordering.

All Ex de motors are delivered as standard with cable glands or cable sealing end units according to the below table. Different glands can be provided separately as an option. Please see Alternatives section for details.

Note: For 500 V motors information please contact ABB!

Standard delivery 400/690 V (if nothing else informed)

Motor size	Pole number	Terminal box type	Terminal box opening	45° adapter (variant code)	Threaded holes	Cable gland	Cable sealing end unit (variant code)	Cable outer diameter mm	Single core cross-section mm ² for rated power	Terminal bolt size 6 x
80-90	2-8	25	B	-	1xM25	1xM25	-	1xØ10-16	10	M5
100-132	2-8	25	B	-	2xM32	2xM32	-	2xØ16-21	10	M5
160-180	2-8	63	B	-	2xM40	2xM40	-	2xØ19-27	35	M6
200-250	2-8	160	B	-	2xM50	2xM50	-	2xØ34-45	70	M10
280	2-8	210	C	-	2xM63	2xM63	-	2xØ32-49	2x150	M12
315SM, ML	2-8	370	D	-	2xM63	2xM63	-	2xØ32-49	2x240	M12
315LKA, LKB	2-4	370	D	-	2xM63	2xM63	-	2xØ32-49	2x240	M12
315LKC	2-4	750	E	E-D (294)	-	-	medium (278)	2xØ48-60	4x240	M12
315 LKA, LKB, LKC	6-8	370	D	-	2xM63	2xM63	-	2xØ32-49	2x240	M12
355 SMA, SMB, SMC	2-4	750	E	E-D (294)	2xM63	2xM63	medium (278)	2xØ48-60	4x240	M12
355 SMC	6	750	E	E-D (294)	2xM63	2xM63	medium (278)	2xØ48-60	4x240	M12
355 SMC	8	370	D	-	2xM63	2xM63	-	2xØ32-49	2x240	M12
355 SMA, SMB	6-8	370	D	-	2xM63	2xM63	-	2xØ32-49	2x240	M12
355 ML, LK	2-4	750	E	E-D (294)	-	-	large (279)	2xØ60-80	4x240	M12
355 ML, LK	6-8	750	E	E-D (294)	-	-	medium (278)	2xØ48-60	4x240	M12
400 L, LK	2-6	750	E	E-D (294)	-	-	large (279)	2xØ60-80	4x240	M12
400 L, LK	8	750	E	E-D (294)	-	-	medium (278)	2xØ48-60	4x240	M12

Auxiliary cable entries

80-132	2-8				1xM20	1xM20		1xØ8-14		
160-400	2-8				2xM20	2xM20		1xØ8-14		

Earthings on motor

	Frame	Terminal box
80-132	M6	M6
160-180	M6	M6
200-250	M8	M8
280-315	M10	2xM10
355-400	M10	2xM10

Examples of terminal boxes and connection parts
 Below pictures show a collection of terminal boxes and connection parts.

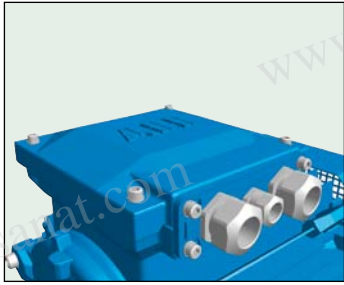

M000718

Fig 1. Terminal box for motor sizes 80-132

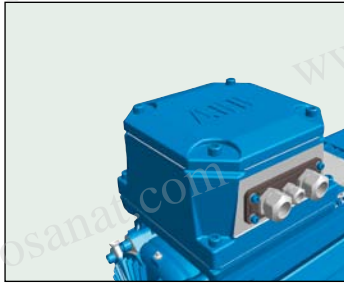

M000719

Fig 2. Terminal box for motor sizes 160-180

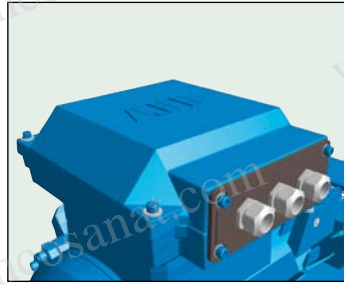

M000720

Fig 3. Terminal box for motor sizes 200-250

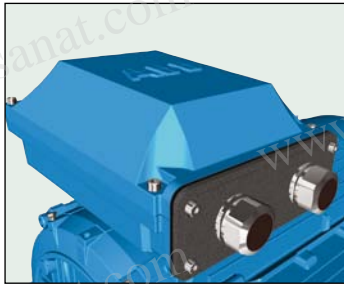

M000423

Fig 4. Terminal box for motor sizes 280-315 with connection flange and cable glands.

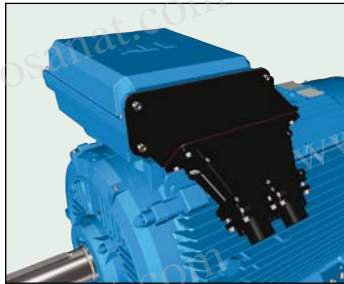

M000424

Fig 5. Terminal box for motor sizes 355-400, with adapter and cable sealing end unit.



M000721

Fig 6. Terminal board for motor sizes 80-132



M000722

Fig 7. Terminal board for motor sizes 160-180

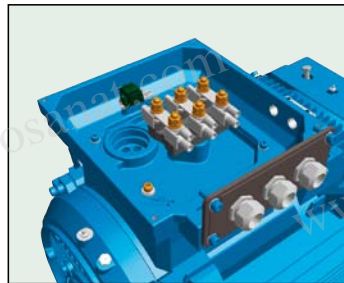

M000723

Fig 8. Terminal board for motor sizes 200-250

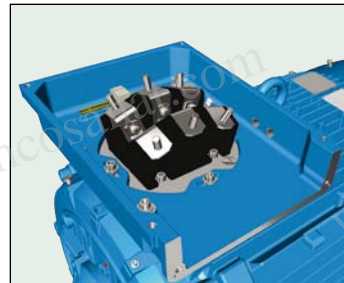

M000427

Fig 9. Terminal board for motor sizes 280-315.



M000428

Fig 10. Terminal board for motor sizes 355-400.

Terminal box alternatives, cast iron frame

Optional adapters

There is a broad selection of cable termination accessories available to allow termination of one or several cables. The most common ones are explained below, for other options please contact ABB.

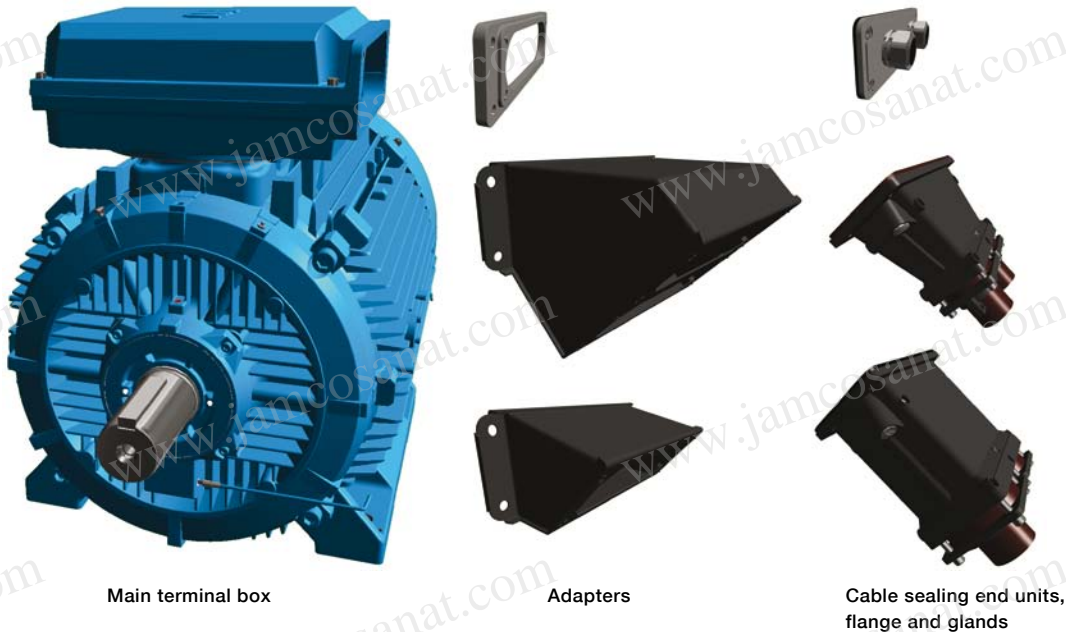

Main terminal box

Adapters

Cable sealing end units, flange and glands

M000443

How to order?

- Check first that the terminal box can allow mounting of the cable and cores (refer to motor type and terminal box type cross reference page 61).
- If very large cables are used might it be necessary to use a larger terminal box than standard. Select the right cable gland(s) or cable sealing end unit(s) depending on outer diameter of the cable(s).
- Select an appropriate adapter and gland(s) and gland plate or cable sealing end unit.
- Note that turning the terminal box to a non standard position might limit the use of some adapters.

Ordering example

Motor	200 kW, 4 pole, 400 V 50 Hz,
Cables	cables needed: 2 pieces, outer diameter 58 mm, single cross section 185mm, cables coming from below
Needed one terminal box for anticondensation heaters (220V) and another for temperature detectors, terminal box material cast iron.	
Motor	M3KP 315 MLA 4, B3
Adapter	D-D (variant code 293)
Cable sealing end unit	Variant code 278
Auxiliaries	Variant codes 451, 380, 567, 568

1. Main terminal box and maximum single core cross section

Larger than standard single core cross section is available as option according to the table below. Also one size larger terminal box can be selected. Please check also the capacity of the cable entry to make sure the cables fit.



Standard terminal box	Size of opening	Max single cross section per phase mm ²	Variant code 019 larger terminal box than standard	Size of opening with larger terminal box than standard Variant code 019	Max single cross section per phase mm ²
25	B	35	-	-	-
63	B	95	-	-	-
160	C	120	-	-	-
210	C	2 x 240	370	D	2 x 300
370	D	2 x 300	750	E	4 x 500
750	E	4 x 500	1200	E	4 x 500

The accessories for using the maximum single core cross sections are not included as standard. For this option please use variant code 300 (Increased single core cross section). Each terminal has got limited maximum cable entry size, please request if necessary.

2. Optional adapters

To allow easy termination of cables entering the terminal box from above or below is it recommended to use an angle adapter.

These can also be used to allow mounting of several cable sealing end units or gland plates on the terminal box for termination of more cables than one cable sealing end unit or gland plate can allow.

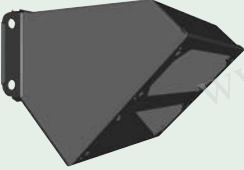
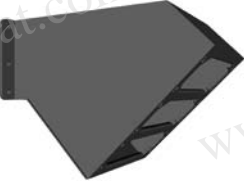
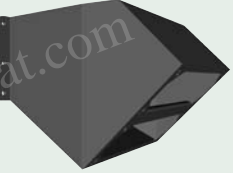
Adapter	Variant code	Opening towards terminal box	Glandplate or opening for cable sealing end unit	Material	Notes
	292 M000430	C	C	Steel	
	293 M000431	D	D	Steel	
	294 M000432	E	D	Steel	Included in std delivery with 750 type terminal box
	295 M000433	E	2 pcs E	Steel	Only possible on terminal box 1200
	296 M000434	E	3 pcs D	Steel	Only possible on terminal box 1200
	444 M000435	E	2 pcs D	Steel	Included in std delivery with 1200 type terminal box

Note: Black painted steel

3. Glandplate, maximum size of glands and material

Glandplates delivered blind or be drilled and tapped to accommodate glands to suit the cable diameter and amount of glands needed.

Standard gland plate material is siluminium, painted steel or stainless steel are available as options.

Size	Maximum size and number of glands, metric		
C	2xM90	3xM50	7xM32
D	4xM90	4xM63	7xM50
E	6xM90	7xM63	9xM50

Related variant codes:

- 729 Cable flanges without holes / Blank gland plates.
- 730 Prepared for NPT glands
- 732 Standard cable gland, Ex d IIB, armoured cable.
- 733 Standard cable gland, Ex d IIB, non-armoured cable.
- 743 Painted steel, blind
- 744 Stainless steel, blind
- 745 Painted steel with brass glands
- 746 Stainless steel with brass glands

4. Cable glands and cable sealing end units

Cable glands

Table below shows the selection of cable gland types and possible cable outer diameter of each size.

	Outer diameter, mm		
	Variant code 745 Painted steel flange equipped with brass cable glands	Variant code 737 Standard cable gland Ex e with clamping device acc. to EN-Standards	Variant code 704 EMC cable gland
Motor sizes 80-400:			
M20	8-14	8-14	8-14
M25	10-16	10-16	10-16
M32	14-21	14-21	14-21
M40	18-27	18-27	18-27
M50	26-35	26-35	26-35
M63	32-49	32-49	32-49
M75	46-60	NA	NA
M90	55-70	NA	NA



For armoured and NPT cable glands please contact ABB.

Cable sealing end unit

As an alternative to flanges and cable glands, cable sealing units can be used. These allow more space for spreading the cores for easy terminating on the terminals.

Cable sealing end units have rubber sealed entries for one or two main cables. In addition are there two M20 plugged holes for auxiliary cables.



	Variant code	Opening towards terminal box	Cable outer diameter mm	Cable entry auxiliary cable	Accessories	
					Variant code 704; EMC cable gland	Variant code 231; Standard cable gland with clamping device
	277	C	1 or 2 pcs (48-60 mm *)	2 pcs M20 plugged holes	Optional	Optional
	278	D	1 or 2 pcs (48-60 mm *)	2 pcs M20 plugged holes	Optional	Optional
	279	D	1 or 2 pcs (60-80 mm *)	2 pcs M20 plugged holes	Optional	Optional

*) Depending on how the cable seal inside the cable sealing end unit is used also 40-52mm is available.

5. Auxillary terminal box

It's possible to equip the motors from frame size 160 upwards with one or several auxillary terminal boxes for connection of auxiliaries like heaters or temperature detectors.

The standard auxillary terminal box is made of aluminium and equipped with M20 glands for entry of the connection cables. As an option cast iron terminal box is available.

Connection terminals are spring loaded type for quick and easy connection. These are suitable for up to 2,5mm² wires. Auxillary terminal boxes are equipped with an earthing terminal.

As standard the first auxillary terminal box is located on RHS seen from D-end.

Small, aluminum auxiliary terminal box
(80 x 125 mm, for max 12 wires)
Earthing size M4



M000439

Large, aluminum auxiliary terminal box
(80 x 250 mm, for max 30 wires)
Earthing size M4



M000440

Cast iron auxiliary terminal box
(211 x 188 mm, for max 30 wires)
Earthing size M6



M000441

Standard cable entry size M20. Number of entries depends on the terminal box type and number of selected auxiliaries.

Related variant codes:

- 418 Separate terminal box for auxiliaries, standard material (all connections of temperature detectors and heaters will be put in same box)
- 380 Separate terminal box for temperature detectors, standard material
- 568 Separate terminal box for heating elements, standard material
- 569 Separater terminal box for brakes, standard material
- 567 Separate terminal box material: Cast iron

Dimension drawings Flameproof motors, Ex de

Terminal boxes, standard with 6 terminals

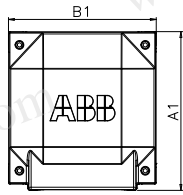

M000368

Motor sizes 80 - 132

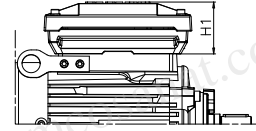

M000368

Motor sizes 160 - 180

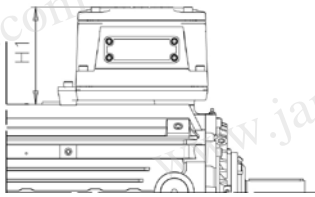

M000365

Motor sizes 200 - 250

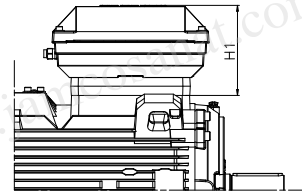

M000369

Motor sizes 280 - 315

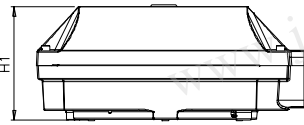

Motor sizes 355 - 400

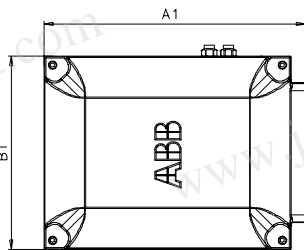
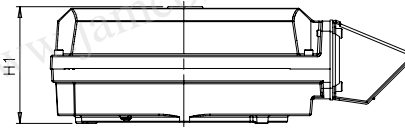

M000205

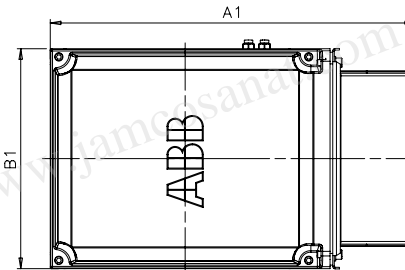

M000206

Ex de - M3KP

Motor size	Terminal box	A1	B1	H1
80-132	25	202	188	66
160-180	63	234	234	68
200-250	160	352	319	184
280-400	210	416	306	177
	370	451	347	200
	750 top-mounted	686	413	219

For motor dimensions please see dimension drawings on earlier pages.

Permissible loadings on the shaft end

The following tables give the permissible radial and axial forces in Newton, assuming only radial or axial force is applied. Permissible loads of simultaneous radial and axial forces will be supplied on request.

The bearing life, L_{10} , is calculated according to ISO 281:1990/ Amd 2:2000 standard theory, which also takes the purity of the grease into consideration. An adequate lubrication is a necessary prerequisite for the table below.

The values are based on normal conditions at 50 Hz. At 60 Hz the values must be reduced by 10 %. For two-speed motors, the values must be based on the higher speed.

Motors are foot-mounted IM B3 version with force directed sideways. In some cases the strength of the shaft affects the permissible forces.

If flameproof motors Ex de sizes 160 and above are subject to high radial forces (e.g. belt drive) they should be fitted with roller bearings. Permissible radial forces for IIB and IIC are available from ABB on request.

Please note that motors type Ex de IIB and IIC in size 250 and above with roller bearings may require detailed information about power transmission; please consult ABB.

If the radial force is applied between points X_0 and X_{max} , the permissible force F_R can be calculated from the following formula:

$$F_R = F_{X_0} - \frac{X}{E} (F_{X_0} - F_{X_{max}})$$

E = length of shaft extension in basic version

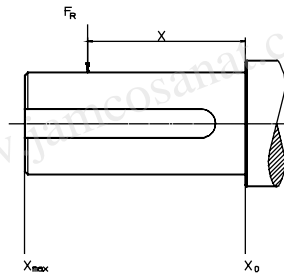

M000145

Cast iron motors

Permissible radial forces according to L_{10} principle

Flameproof motor sizes 80-132

Motor size	Poles	Length of shaft extension E (mm)	Ball bearings 40,000 hours	
			F_{X_0} (N)	$F_{X_{max}}$ (N)
80	2	40	619	524
	4	40	780	663
	6	40	893	759
	8	40	983	834
90	2	50	561	473
	4	50	803	677
	6	50	919	775
	8	50	1011	853
100	2	60	553	457
	4	60	1050	868
	6	60	1267	1047
	8	60	1395	1153
112	2	60	553	457
	4	60	1050	868
	6	60	1267	1047
	8	60	1394	1152
132	2	80	1354	1112
	4	80	1772	1454
	6	80	2028	1665
	8	80	2234	1833

Cast iron motors

Permissible radial forces according to L_{10} principle

Flameproof motors Ex de IIB/IIC, motor sizes 160 - 355

Motor size	Poles	Length of shaft extension E (mm)	Ball bearings IIB ²⁾ L_{10} h=40 000 h		Ball bearings IIB/IIC L_{10} h=40 000 h		Roller bearings IIB ²⁾ L_{10} h=40 000 h		Roller bearings IIC L_{10} h=40 000 h	
			F_{X_0} [N]	$F_{X_{max}}$ [N]	F_{X_0} [N]	$F_{X_{max}}$ [N]	F_{X_0} [N]	$F_{X_{max}}$ [N]	F_{X_0} [N]	$F_{X_{max}}$ [N]
160 ML_	2	110	2530	2120	2530	2120	6400	1800	6400	1800
	4	110	3180	2670	3180	2670	7600	1800	7600	1800
	6	110	3650	3040	3650	3040	7600	1800	7600	1800
	8	110	4020	3040	4020	3040	7600	1800	7600	1800
180 ML_	2	110	2900	2440	2900	2440	6970	2700	6970	2700
	4	110	3660	3080	3660	3080	8500	2700	8500	2700
	6	110	4190	3520	4190	3520	8500	2700	8500	2700
	8	110	4620	3880	4620	3880	8500	2700	8500	2700
200 ML_	2	110	3830	3150	3830	3150	9510	7000	9510	4200
	4	110	4820	3980	4820	3980	11710	7000	11710	4200
	6	110	5520	4550	5520	4550	13230	7000	13230	4200
	8	110	6080	5000	6080	5000	14420	7000	14420	4200
225 SM_	2	110	4350	3660	4350	3660	11650	7000	9300	3000
	4	140	5490	2800	5490	2800	14340	7200	9300	2200
	6	140	6280	2800	6280	2800	16190	7200	9300	2200
	8	140	6920	2800	6920	2800	17300	7200	9300	2200
250 SM_	2	140	5390	4350	5390	2900	15420	6700	¹⁾	¹⁾
	4	140	6790	5480	6790	2800	18980	9200	¹⁾	¹⁾
	6	140	7760	6270	3000	2800	21000	9200	¹⁾	¹⁾
	8	140	8550	6900	3000	2800	21000	9200	¹⁾	¹⁾
280 SM_	2	140	5840	4900	³⁾	³⁾	16550	6000	Not available	
	4	140	7260	6110	³⁾	³⁾	20100	9200	Not available	
	6	140	8300	6980	³⁾	³⁾	22690	9200	Not available	
	8	140	9150	7700	³⁾	³⁾	24740	9200	Not available	
315 SM_	2	140	5810	4960	³⁾	³⁾	16540	6000	Not available	
	4	170	9030	7470	³⁾	³⁾	26590	9600	Not available	
	6	170	10310	8530	³⁾	³⁾	39030	9600	Not available	
	8	170	11370	9410	³⁾	³⁾	32740	9600	Not available	
315 ML_	2	140	5850	5080	³⁾	³⁾	16710	5850	Not available	
	4	170	9000	7620	³⁾	³⁾	26580	13040	Not available	
	6	170	10270	8500	³⁾	³⁾	30010	10040	Not available	
	8	170	11330	9380	³⁾	³⁾	32730	9940	Not available	
355 SM_	2	140	5790	5090	³⁾	³⁾	Not available	Not available	Not available	
	4-8	210	11930	9890	³⁾	³⁾	Not available	Not available	Not available	
355 ML_	2	140	5770	5120	³⁾	³⁾	Not available	Not available	Not available	
	4-8	210	11980	10090	³⁾	³⁾	Not available	Not available	Not available	
355 LK_	2	140	5500	5000	³⁾	³⁾	Not available	Not available	Not available	
	4-8	210	12050	10450	³⁾	³⁾	Not available	Not available	Not available	
400 L_	2	170	³⁾	³⁾	³⁾	³⁾	Not available	Not available	Not available	
	4-8	210	³⁾	³⁾	³⁾	³⁾	Not available	Not available	Not available	
400 LK_	2	170	³⁾	³⁾	³⁾	³⁾	Not available	Not available	Not available	
	4-8	210	³⁾	³⁾	³⁾	³⁾	Not available	Not available	Not available	

¹⁾ On request

²⁾ IIB on request, requires special construction.

³⁾ Flameproof motors Ex d IIC - sizes 280-315 only allowed for direct coupling applications.

Permissible axial forces according to L₁₀ principle

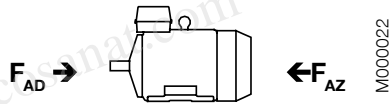

Cast iron motors, sizes 80 - 400

Mounting arrangement IM B3

Motor size	20,000 hours								40,000 hours							
	2-pole		4-pole		6-pole		8-pole		2-pole		4-pole		6-pole		8-pole	
	F _{AD} N	F _{AZ} N	F _{AD} N	F _{AZ} N	F _{AD} N	F _{AZ} N	F _{AD} N	F _{AZ} N	F _{AD} N	F _{AZ} N	F _{AD} N	F _{AZ} N	F _{AD} N	F _{AZ} N	F _{AD} N	F _{AZ} N
80	820	460	1010	650	1180	820	1) ¹⁾	1) ¹⁾	1) ¹⁾	1) ¹⁾	1) ¹⁾	1) ¹⁾	1) ¹⁾	1) ¹⁾	1) ¹⁾	1) ¹⁾
90	900	380	1110	590	1260	740	1) ¹⁾	1) ¹⁾	1) ¹⁾	1) ¹⁾	1) ¹⁾	1) ¹⁾	1) ¹⁾	1) ¹⁾	1) ¹⁾	1) ¹⁾
100	1330	440	1620	730	1820	940	1) ¹⁾	1) ¹⁾	1) ¹⁾	1) ¹⁾	1) ¹⁾	1) ¹⁾	1) ¹⁾	1) ¹⁾	1) ¹⁾	1) ¹⁾
112	1330	440	1610	720	1820	930	1) ¹⁾	1) ¹⁾	1) ¹⁾	1) ¹⁾	1) ¹⁾	1) ¹⁾	1) ¹⁾	1) ¹⁾	1) ¹⁾	1) ¹⁾
132 S ₋	1880	850	2330	1290	2650	1610	1) ¹⁾	1) ¹⁾	1) ¹⁾	1) ¹⁾	1) ¹⁾	1) ¹⁾	1) ¹⁾	1) ¹⁾	1) ¹⁾	1) ¹⁾
160	2820	1910	3560	2650	4150	3240	4630	3720	2220	1310	2780	1870	3230	2320	3590	2680
180	3190	2280	4080	3170	4720	3810	5260	4350	2500	1590	3160	2250	3640	2740	4060	3150
200	4230	2960	5380	4120	6270	5000	6960	5700	3320	2060	4184	2920	4850	3590	5380	4120
225	4740	3270	6070	4600	7020	5550	7830	6360	3720	2250	4720	3250	5430	3970	6050	4590
250	6470	3370	8100	5000	9250	6150	10220	7130	5220	2130	6440	3340	7300	4210	8040	4950
280 SM ₋	4200	6250	6000	8000	5250	11250	8300	10300	2900	4900	4250	6250	5150	7150	5950	7950
315 SM ₋	4180	6200	7400	9400	8900	10900	10000	12000	2850	4850	5250	7250	6350	8350	7200	9000
315 ML ₋	4050	6050	7250	9250	8650	10650	9500	11900	2750	4750	5100	7100	6100	8100	6900	8800
315 LK ₋	4000	5950	7100	9150	8500	10500	9750	11750	2650	4650	5000	7000	5950	7950	6900	8900

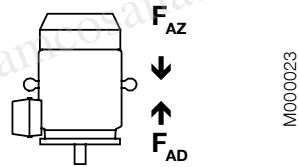

Mounting arrangement IM V1

Motor size	20,000 hours								40,000 hours							
	2-pole		4-pole		6-pole		8-pole		2-pole		4-pole		6-pole		8-pole	
	F _{AD} N	F _{AZ} N	F _{AD} N	F _{AZ} N	F _{AD} N	F _{AZ} N	F _{AD} N	F _{AZ} N	F _{AD} N	F _{AZ} N	F _{AD} N	F _{AZ} N	F _{AD} N	F _{AZ} N	F _{AD} N	F _{AZ} N
80	850	440	1060	650	1220	800	1) ¹⁾	1) ¹⁾	1) ¹⁾	1) ¹⁾	1) ¹⁾	1) ¹⁾	1) ¹⁾	1) ¹⁾	1) ¹⁾	1) ¹⁾
90	940	350	1150	550	1320	690	1) ¹⁾	1) ¹⁾	1) ¹⁾	1) ¹⁾	1) ¹⁾	1) ¹⁾	1) ¹⁾	1) ¹⁾	1) ¹⁾	1) ¹⁾
100	1400	390	1710	650	1940	860	1) ¹⁾	1) ¹⁾	1) ¹⁾	1) ¹⁾	1) ¹⁾	1) ¹⁾	1) ¹⁾	1) ¹⁾	1) ¹⁾	1) ¹⁾
112	1410	380	1730	640	1950	850	1) ¹⁾	1) ¹⁾	1) ¹⁾	1) ¹⁾	1) ¹⁾	1) ¹⁾	1) ¹⁾	1) ¹⁾	1) ¹⁾	1) ¹⁾
132 S ₋	2010	730	2520	1150	2890	1440	1) ¹⁾	1) ¹⁾	1) ¹⁾	1) ¹⁾	1) ¹⁾	1) ¹⁾	1) ¹⁾	1) ¹⁾	1) ¹⁾	1) ¹⁾
160	3070	1660	4060	2320	4530	2890	4950	3350	2470	1060	3280	1530	3600	1970	3910	2310
180	3580	1980	4650	2680	5430	3340	5970	3890	2880	1280	3730	1760	4360	2260	4760	2680
200	4790	2480	6240	3550	7070	4300	7850	5020	3870	1560	5030	2340	5650	2890	6260	3430
225	5540	2670	7000	3860	8130	4700	8860	5480	4510	1650	5640	2500	6540	3100	7080	3700
250	7390	2640	9200	4080	10670	5000	11660	5970	6135	1380	7530	2410	8710	3040	9470	3780
280 SM ₋	5550	5150	7600	6550	9150	7500	10200	9000	4200	3800	5800	4750	7000	5350	7850	6700
315 SM ₋	5950	4600	9750	7500	11600	8300	13350	9900	4600	3300	7550	5300	9050	5750	10450	7000
315 ML ₋	6650	4300	10500	7050	12900	7800	13400	8300	5300	2900	8300	4900	10350	5250	11600	5400
315 LK ₋	7100	3350	11100	5850	13700	6100	14900	8300	5750	2450	8900	3700	11100	3550	12100	5450

¹⁾ On request

Rating plates

The rating plates are in table form giving values for speed, current and power factor for three voltages: 400V-415V-690V as standard. Other voltage and frequency combinations are possible and can be ordered with variant codes 002 or 209. Please see Variant code section.

The following information will be shown on the motor rating plate according to IEC 60034-30:2008:

- Lowest nominal efficiency at 100%, 75% and 50% rated load
- Efficiency level
- Year of manufacture
- Type of protection
- Apparatus group
- Temperature class
- Identification number of the certification body
- Certificate number (both ATEX and IECEx are stamped on the rating plate as standard)

Motor sizes 80-400

ABB Oy, Motors Vaasa, Finland						
CE 0081		IE2		Ex II 2G		
3 ~ Motor M3KP 225SMC 4 IMB3/IM1001						
Ex de IIB T4						
414141-43		2010		No. 3GF1000002		
		Ins.cl.		F		IP 55
V	Hz	kW	r/min	A	cos φ	Duty
690 Y	50	45	1477	45	0.88	S1
400 D	50	45	1477	78	0.88	S1
415 D	50	45	1479	77	0.86	S1
IE2 - 94.1% (100%) - 94.6% (75%) - 94.4% (50%)						
Prod. code 3GKP222230-ADG						
LCIE 00 ATEX 6029 / IECEx LCI 04.0005						
			Nmax		r/min	
6313/C3		6312/C3		405		kg
ABB		IEC 60034-1				

M000732

Ordering information

Sample order

When placing an order, please state the following minimum data in the order, as in example.

The product code of the motor is composed in accordance with the following example.

Motor type	M3KP 160 MLA
Pole number	2
Mounting arrangement (IM code)	IM B3 (IM 1001)
Rated output	11 kW
Product code	3GKP161410-ADH
Variant codes if needed	

Motor size

A	B	C	D.E.F.	G														
M3KP 160 MLA 3GKP 161 410 - A D H 002 etc.																		
<table border="1" style="margin: auto;"> <tr> <td>1</td><td>2</td><td>3</td><td>4</td><td>5</td><td>6</td><td>7</td><td>8</td><td>9</td><td>10</td><td>11</td><td>12</td><td>13</td><td>14</td> </tr> </table>					1	2	3	4	5	6	7	8	9	10	11	12	13	14
1	2	3	4	5	6	7	8	9	10	11	12	13	14					
A Motor type		C Product code	E Voltage and frequency code	G Variant codes														
B Motor size		D Mounting arrangement code	F Generation code															

Explanation of the product code:

Positions 1 - 4

3GKP = Totally enclosed flameproof motor Ex de with cast iron frame

Positions 5 and 6

IEC-frame size

08 = 80	20 = 200
09 = 90	22 = 225
10 = 100	25 = 250
11 = 112	28 = 280
13 = 132	31 = 315
16 = 160	35 = 355
18 = 180	40 = 400

Position 7

Speed (pole pairs)

1 = 2 poles	4 = 8 poles	7 ≥ 12 poles
2 = 4 poles	5 = 10 poles	8 = Two-speed motors
3 = 6 poles	6 = 12 poles	9 = Multi-speed motors

Position 8-10

Running number series

Position 11

- (Dash)

Position 12

Mounting arrangement

A = Foot-mounted, top mounted terminal box
R = Foot-mounted, terminal box RHS seen from D-end
L = Foot-mounted, terminal box LHS seen from D-end
B = Flange-mounted, large flange with clearance holes
C = Flange-mounted, small flange with tapped holes
V = Flange-mounted, Special flange
H = Foot/flange-mounted, large flange with clearance holes
J = Foot/flange-mounted, small flange with tapped holes
S = Foot/flange-mounted, terminal box RHS seen from D-end
T = Foot/flange-mounted, terminal box LHS seen from N-end
F = Foot/flange-mounted, special flange

Position 13

Voltage and frequency

Single-speed motors

B 380 VΔ 50 Hz
D 400 VΔ, 415 VΔ, 690 VY 50 Hz
E 500 VΔ 50 Hz
F 500 VY 50 Hz
S 230 VΔ, 400 VY, 415 VY 50 Hz
T 660 VΔ 50 Hz
U 690 VΔ 50 Hz
X Other rated voltage, connection or frequency, 690 V maximum

Position 14

Generation code G/H

Generation code is followed by variant codes according to the hazardous area, see below and on corresponding pages with variant codes:

461 Ex d(e) design, Group IIC

Flameproof cast iron motors Ex de IIB/IIC T4

Technical data for totally enclosed squirrel cage three phase motors

IE2

IP 55 - IC 411 - Insulation class F, temperature rise class B
IE2 efficiency class according to IEC 60034-30; 2008



Output kW	Motor type	Product code	Speed r/min	Efficiency IEC 60034-2-1; 2007			Power factor cos φ	Current		Torque			Moment of inertia J = 1/4 GD ² kgm ²	Weight kg	Sound pressure level L _{FA} dB
				Full load 100%	3/4 load 75%	1/2 load 50%		I _N A	I _s I _N	T _N Nm	T _I T _N	T _b T _N			
3000 r/min = 2-poles 400 V 50 Hz			CENELEC-design												
0.75	M3KP 80 MA	3GKP 081 310-••H	2861	80.1	79.4	76.2	0.87	1.55	7.3	2.5	3.7	3.8	0.0006	37	59
1.1	M3KP 80 MB	3GKP 081 320-••H	2831	80.5	81.1	79.5	0.89	2.2	5.7	3.7	3.0	3.2	0.0007	39	59
1.5	M3KP 90 SLA	3GKP 091 010-••H	2881	81.9	82.1	80.1	0.88	3.0	6.7	4.9	3.0	3.5	0.001	50	61
2.2	M3KP 90 SLC	3GKP 091 030-••H	2871	84.4	85.0	83.8	0.90	4.1	7.5	7.3	2.7	3.5	0.0014	53	61
3	M3KP 100 LA	3GKP 101 510-••H	2896	85.2	85.5	84.0	0.90	5.6	7.2	9.8	2.2	3.0	0.0036	70	65
4	M3KP 112 MB	3GKP 111 320-••H	2901	85.9	86.5	85.3	0.90	7.4	7.2	13.1	3.6	3.7	0.0043	73	65
5.5	M3KP 132 SMB	3GKP 131 220-••H	2905	87.2	87.5	86.1	0.90	10.1	7.0	18.0	2.4	3.3	0.009	101	71
7.5	M3KP 132 SMD	3GKP 131 240-••H	2914	88.3	88.7	87.6	0.90	13.6	7.6	24.5	2.8	3.6	0.012	109	71
11	M3KP 160 MLA	3GKP 161 410-••H	2931	90.1	90.5	89.6	0.89	19.7	7.2	35.8	2.6	3.1	0.043	213	71
15	M3KP 160 MLB	3GKP 161 420-••H	2929	91.2	91.9	91.4	0.89	26.6	7.2	48.9	3.0	3.5	0.052	222	71
18.5	M3KP 160 MLC	3GKP 161 430-••H	2934	91.8	92.2	91.8	0.90	32.3	7.5	60.2	2.8	3.4	0.062	233	69
22	M3KP 180 MLA	3GKP 181 410-••H	2938	91.7	92.2	91.7	0.90	38.4	7.0	71.5	2.5	3.1	0.089	265	69
30	M3KP 200 MLA	3GKP 201 410-••G	2956	93.2	93.6	93.0	0.88	52.7	7.4	96.9	3.0	3.2	0.15	310	74
37	M3KP 200 MLC	3GKP 201 430-••G	2954	93.6	94.0	93.4	0.89	64.1	7.5	119	2.8	3.2	0.19	340	75
45	M3KP 225 SMB	3GKP 221 220-••G	2968	93.9	93.8	92.9	0.87	79.5	7.2	144	2.7	3.0	0.26	400	76
55	M3KP 250 SMA	3GKP 251 210-••G	2975	94.3	94.1	93.0	0.89	94.5	7.8	176	2.4	3.1	0.49	460	75
75	M3KP 280 SMA	3GKP 281 210-••G	2978	94.3	94.1	92.8	0.88	130	7.6	240	2.1	3.0	0.8	725	77
90	M3KP 280 SMB	3GKP 281 220-••G	2976	94.6	94.5	93.5	0.90	152	7.4	288	2.1	2.9	0.9	765	77
110	M3KP 315 SMA	3GKP 311 210-••G	2982	94.9	94.4	92.9	0.86	194	7.6	352	2.0	3.0	1.2	980	78
132	M3KP 315 SMB	3GKP 311 220-••G	2982	95.1	94.8	93.6	0.88	227	7.4	422	2.2	3.0	1.4	1040	78
160	M3KP 315 SMC	3GKP 311 230-••G	2981	95.4	95.2	94.2	0.89	271	7.5	512	2.3	3.0	1.7	1125	78
200	M3KP 315 MLA	3GKP 311 410-••G	2980	95.7	95.7	94.9	0.90	335	7.7	640	2.6	3.0	2.1	1290	78
250 ³⁾	M3KP 355 SMA	3GKP 351 210-••G	2984	95.7	95.5	94.5	0.89	423	7.7	800	2.1	3.3	3.0	1790	83
315 ³⁾	M3KP 355 SMB	3GKP 351 220-••G	2980	95.7	95.7	95.1	0.89	533	7.0	1009	2.1	3.0	3.4	1870	83
355 ³⁾	M3KP 355 SMC	3GKP 351 230-••G	2984	95.7	95.7	95.2	0.88	608	7.2	1136	2.2	3.0	3.6	1940	83
400 ³⁾	M3KP 355 MLA	3GKP 351 410-••G	2982	96.9	96.6	95.9	0.88	677	7.1	1280	2.3	2.9	4.1	2190	83
450 ³⁾	M3KP 355 MLB	3GKP 351 420-••G	2983	97.1	97.0	96.4	0.90	743	7.9	1440	2.2	2.9	4.3	2270	83
500 ³⁾	M3KP 355 LKA	3GKP 351 810-••G	2982	96.9	96.9	96.5	0.90	827	7.5	1601	2.0	3.9	4.8	2510	83
560 ⁴⁾	M3KP 400 LA	3GKP 401 510-••G	2988	97.2	97.2	96.6	0.89	934	7.8	1789	2.1	3.4	7.9	3230	82
560 ⁴⁾	M3KP 400 LKA	3GKP 401 810-••G	2988	97.2	97.2	96.6	0.89	934	7.8	1789	2.1	3.4	7.9	3230	82
630 ⁴⁾	M3KP 400 LB	3GKP 401 520-••G	2987	97.4	97.4	96.9	0.89	1048	7.8	2014	2.2	3.4	8.2	3330	82
630 ⁴⁾	M3KP 400 LKB	3GKP 401 820-••G	2987	97.4	97.4	96.9	0.89	1048	7.8	2014	2.2	3.4	8.2	3330	82
710 ⁴⁾	M3KP 400 LC	3GKP 401 530-••G	2987	97.5	97.4	97.0	0.89	1180	7.8	2269	2.6	3.4	9.3	3580	82
710 ⁴⁾	M3KP 400 LKC	3GKP 401 830-••G	2987	97.5	97.4	97.0	0.89	1180	7.8	2269	2.6	3.4	9.3	3580	82
3000 r/min = 2-poles 400 V 50 Hz			High-output design												
22 ²⁾	M3KP 160 MLD	3GKP 161 440-••H	2929	91.2	91.6	91.0	0.90	38.6	7.3	71.7	2.7	3.4	0.07	239	77
30	M3KP 180 MLB	3GKP 181 420-••H	2943	92.5	93.0	92.6	0.90	52.0	6.8	97.3	2.3	3.1	0.13	298	78
37	M3KP 180 MLC	3GKP 181 430-••H	2947	92.8	93.0	92.5	0.90	63.9	7.9	119	2.9	3.6	0.13	298	77
45	M3KP 200 MLE	3GKP 201 450-••G	2944	93.3	93.6	93.0	0.88	79.1	7.3	145	2.9	3.1	0.22	345	79
55	M3KP 225 SMC	3GKP 221 230-••G	2965	93.9	93.9	92.9	0.88	96.0	7.1	177	2.6	3.0	0.29	420	80
67 ⁵⁾	M3KP 225 SMD	3GKP 221 240-••G	2966	93.9	93.7	92.6	0.86	119	7.4	215	2.8	3.2	0.31	430	78
75	M3KP 250 SMB	3GKP 251 220-••G	2969	94.0	94.0	93.2	0.89	129	7.9	241	2.6	3.2	0.57	500	80
90 ^{1) 2) 5)}	M3KP 250 SMC	3GKP 251 230-••G	2965	94.0	94.2	93.7	0.90	153	7.7	289	2.6	3.1	0.59	510	80
110	M3KP 280 SMC	3GKP 281 230-••G	2978	95.1	95.0	94.2	0.90	185	7.9	352	2.4	3.0	1.15	825	77

¹⁾ Temperature rise class F

²⁾ Efficiency class IE1

³⁾ 3dB(A) sound pressure level reduction with unidirectional fan construction. Direction of rotation must be stated when ordering, see variant codes 044 and 045

⁴⁾ Unidirectional fan construction as standard. Direction of rotation must be stated when ordering, see variant codes 044 and 045

⁵⁾ For 400-415 V 50 Hz (380 V 50 Hz voltage code B)

The two bullets in the product code indicate choice of mounting arrangements, voltage and frequency code (see ordering information page).

I_s / I_N = Starting current

T_I / T_N = Locked rotor torque

T_b / T_N = Pull-out torque

Efficiency values are given according to IEC 60034-2-1; 2007. Please note that the values are not comparable without knowing the testing method. ABB has calculated the efficiency values according to indirect method, stray load losses (additional losses) determined from measuring.

Flameproof cast iron motors Ex de IIB/IIC T4

IE2

Technical data for totally enclosed squirrel cage three phase motors

IP 55 - IC 411 - Insulation class F, temperature rise class B
IE2 efficiency class according to IEC 60034-30; 2008



Output kW	Motor type	Product code	Speed r/min	Efficiency IEC 60034-2-1; 2007			Power factor cos φ	Current		Torque			Moment of inertia J = 1/4 GD ² kgm ²	Weight kg	Sound pressure level L _{PA} dB
				Full load 100%	3/4 load 75%	1/2 load 50%		I _N A	I _s I _N	T _N Nm	T _I T _N	T _b T _N			
1500 r/min = 4-poles 400 V 50 Hz			CENELEC-adesign												
0.55	M3KP 80 MA	3GKP 082 310-••H	1421	75.4	75.4	72.7	0.76	1.38	4.9	3.6	2.3	2.7	0.001	38	59
0.75	M3KP 80 MB	3GKP 082 320-••H	1412	80.4	80.5	78.4	0.76	1.77	5.2	5.0	2.2	2.7	0.0012	38	59
1.1	M3KP 90 SLA	3GKP 092 010-••H	1435	81.8	81.8	79.5	0.81	2.3	5.9	7.3	2.8	3.5	0.002	51	54
1.5	M3KP 90 SLC	3GKP 092 030-••H	1431	83.2	82.8	80.4	0.79	3.2	6.5	10.0	2.3	3.0	0.003	53	54
2.2	M3KP 100 LA	3GKP 102 510-••H	1441	84.7	85.6	84.8	0.86	4.3	7.0	14.5	2.7	3.3	0.0075	70	52
3	M3KP 100 LB	3GKP 102 520-••H	1442	85.7	86.5	85.7	0.83	6.0	7.0	19.8	2.7	3.4	0.0081	72	52
4	M3KP 112 MC	3GKP 112 330-••H	1455	86.9	86.4	83.8	0.76	8.7	8.3	26.2	3.0	3.8	0.013	81	52
5.5	M3KP 132 SMB	3GKP 132 220-••H	1458	87.7	87.8	86.2	0.79	11.4	7.0	36.0	3.0	3.5	0.023	111	60
7.5	M3KP 132 SMD	3GKP 132 240-••H	1460	89.1	89.1	87.6	0.75	16.1	6.8	49.0	3.3	3.7	0.034	114	60
11	M3KP 160 MLC	3GKP 162 430-••H	1470	91.2	91.5	90.6	0.82	21.2	7.8	71.4	3.0	3.5	0.096	232	62
15	M3KP 160 MLE	3GKP 162 450-••H	1467	92.0	92.4	92.1	0.84	28.0	7.8	97.6	3.0	3.5	0.13	255	61
18.5	M3KP 180 MLA	3GKP 182 410-••H	1474	91.6	92.0	91.2	0.83	35.1	7.2	119	2.6	3.1	0.19	277	62
22	M3KP 180 MLB	3GKP 182 420-••H	1471	91.6	92.4	92.2	0.83	41.7	6.8	142	2.5	3.0	0.21	285	62
30	M3KP 200 MLB	3GKP 202 420-••G	1475	93.6	94.0	93.7	0.85	54.4	7.4	194	3.0	2.8	0.34	340	61
37	M3KP 225 SMB	3GKP 222 220-••G	1480	93.6	93.9	93.4	0.85	67.1	7.6	238	3.2	2.9	0.42	390	67
45	M3KP 225 SMC	3GKP 222 230-••G	1477	94.1	94.6	94.4	0.88	78.4	7.6	290	3.2	2.7	0.49	425	67
55	M3KP 250 SMA	3GKP 252 210-••G	1479	94.3	94.3	93.6	0.84	100	7.2	355	2.5	3.1	0.72	450	66
75	M3KP 280 SMA	3GKP 282 210-••G	1484	94.5	94.5	93.9	0.85	134	6.9	482	2.5	2.8	1.25	725	68
90	M3KP 280 SMB	3GKP 282 220-••G	1483	94.7	94.8	94.4	0.86	159	7.2	579	2.5	2.7	1.5	765	68
110	M3KP 315 SMA	3GKP 312 210-••G	1487	95.1	95.1	94.3	0.86	194	7.2	706	2.0	2.5	2.3	1000	70
132	M3KP 315 SMB	3GKP 312 220-••G	1487	95.4	95.4	94.7	0.86	232	7.1	847	2.3	2.7	2.6	1060	70
160	M3KP 315 SMC	3GKP 312 230-••G	1487	95.6	95.6	95.1	0.85	284	7.2	1027	2.4	2.9	2.9	1100	70
200	M3KP 315 MLA	3GKP 312 410-••G	1486	95.6	95.6	95.3	0.86	351	7.2	1285	2.5	2.9	3.5	1260	70
250	M3KP 355 SMA	3GKP 352 210-••G	1488	95.9	95.9	95.5	0.86	437	7.1	1604	2.3	2.7	5.9	1800	74
315	M3KP 355 SMB	3GKP 352 220-••G	1488	95.9	95.9	95.6	0.86	551	7.3	2021	2.3	2.8	6.9	1970	74
355	M3KP 355 SMC	3GKP 352 230-••G	1487	95.9	95.9	95.7	0.86	621	6.8	2279	2.4	2.7	7.2	2010	78
400	M3KP 355 MLA	3GKP 352 410-••G	1489	96.3	96.3	95.9	0.85	705	6.8	2565	2.3	2.6	8.4	2330	78
450	M3KP 355 MLB	3GKP 352 420-••G	1490	96.8	96.8	96.3	0.86	780	6.9	2884	2.3	2.9	8.4	2330	78
500	M3KP 355 LKA	3GKP 352 810-••G	1490	97.0	97.0	96.5	0.86	865	6.8	3204	2.0	3.0	10.0	2690	78
560	M3KP 400 LA	3GJP 402 510-••G	1491	96.8	96.8	96.3	0.85	982	7.4	3586	2.4	2.8	15.0	3200	78
560	M3KP 400 LKA	3GKP 402 810-••G	1491	96.8	96.8	96.3	0.85	982	7.4	3586	2.4	2.8	15.0	3200	78
630	M3KP 400 LB	3GKP 402 520-••G	1491	97.0	97.0	96.5	0.87	1077	7.6	4034	2.2	2.9	16.0	3580	78
630	M3KP 400 LKB	3GKP 402 820-••G	1491	97.0	97.0	96.5	0.87	1077	7.6	4034	2.2	2.9	16.0	3580	78
710 ¹⁾	M3KP 400 LC	3GKP 402 530-••G	1491	97.1	97.1	96.6	0.86	1227	7.6	4547	2.4	3.0	17.0	3680	78
710 ¹⁾	M3KP 400 LKC	3GKP 402 830-••G	1491	97.1	97.1	96.6	0.86	1227	7.6	4547	2.4	3.0	17.0	3680	78
1500 r/min = 4-poles 400 V 50 Hz			High-output design												
18.5	M3KP 160 MLF	3GKP 162 460-••H	1469	91.7	92.1	91.4	0.83	35.0	7.8	120	3.2	3.5	0.13	255	68
22 ²⁾	M3KP 160 MLG	3GKP 162 470-••H	1466	90.8	91.1	90.4	0.81	43.1	7.9	143	3.3	3.6	0.13	255	68
30 ¹⁾²⁾	M3KP 180 MLC	3GKP 182 430-••H	1473	92.2	92.3	91.6	0.81	57.9	7.1	194	2.8	3.2	0.248	304	66
37	M3KP 200 MLC	3GKP 202 430-••G	1475	93.0	93.1	92.3	0.82	70.0	7.5	239	3.5	3.2	0.34	340	73
55	M3KP 225 SMD	3GKP 222 240-••G	1483	94.3	94.5	93.9	0.83	101	7.4	354	3.4	2.9	0.55	445	68
62 ²⁾³⁾	M3KP 225 SME	3GKP 222 250-••G	1477	93.5	93.7	93.0	0.84	113	7.7	400	3.5	2.9	0.55	445	74
75	M3KP 250 SMB	3GKP 252 220-••G	1476	94.3	94.5	94.2	0.86	133	7.6	485	2.8	3.2	0.88	505	73
86 ²⁾	M3KP 250 SMC	3GKP 252 230-••G	1477	94.1	94.4	94.0	0.85	155	7.8	556	2.9	3.5	0.98	530	74
110	M3KP 280 SMC	3GKP 282 230-••G	1485	95.1	95.2	94.7	0.86	194	7.6	707	3.0	3.0	1.85	825	68

¹⁾ Temperature rise class F

²⁾ Efficiency class IE1

³⁾ For 400-415 V 50 Hz (380 V 50 Hz voltage code B)

The two bullets in the product code indicate choice of mounting arrangements, voltage and frequency code (see ordering information page).

I_s / I_N = Starting current

T_I / T_N = Locked rotor torque

T_b / T_N = Pull-out torque

Efficiency values are given according to IEC 60034-2-1; 2007. Please note that the values are not comparable without knowing the testing method.

ABB has calculated the efficiency values according to indirect method, stray load losses (additional losses) determined from measuring.

Flameproof cast iron motors Ex de IIB/IIC T4

Technical data for totally enclosed squirrel cage three phase motors

IE2

IP 55 - IC 411 - Insulation class F, temperature rise class B
IE2 efficiency class according to IEC 60034-30; 2008



Output kW	Motor type	Product code	Speed r/min	Efficiency IEC 60034-2-1; 2007			Power factor cos φ	Current		Torque			Moment of inertia J = 1/4 GD ² kgm ²	Weight kg	Sound pressure level L _{PA} dB
				Full load 100%	3/4 load 75%	1/2 load 50%		I _N A	I _s I _N	T _N Nm	T _I T _N	T _b T _N			
1000 r/min = 6-poles 400 V 50 Hz			CENELEC-design												
0.37	M3KP 80 MA	3GKP 083 310-••H	953	72.6	70.3	64.6	0.64	1.14	4.8	3.7	3.4	3.6	0.0022	38	50
0.55	M3KP 80 MB	3GKP 083 320-••H	938	72.9	71.7	67.0	0.70	1.55	4.3	5.5	2.8	2.9	0.0022	38	50
0.75	M3KP 90 SLA	3GKP 093 010-••H	946	77.9	77.1	73.4	0.69	2.0	4.9	7.5	2.1	2.8	0.0037	52	44
1.1	M3KP 90 SLC	3GKP 093 030-••H	933	78.5	78.8	76.3	0.71	2.8	4.7	11.2	1.8	2.4	0.0048	53	44
1.5	M3KP 100 LA	3GKP 103 510-••H	951	80.1	80.0	77.4	0.74	3.6	4.2	15.0	2.3	2.9	0.012	69	54
2.2	M3KP 112 MB	3GKP 113 320-••H	950	82.0	82.5	80.6	0.76	5.0	5.9	22.1	2.2	2.8	0.014	72	54
3	M3KP 132 SMB	3GKP 133 220-••H	961	83.3	83.0	80.4	0.77	6.7	6.1	29.8	2.1	3.0	0.032	105	57
4	M3KP 132 SMC	3GKP 133 230-••H	964	84.6	84.3	81.8	0.74	9.2	6.6	39.6	2.3	3.4	0.034	107	57
5.5	M3KP 132 SMD	3GKP 133 240-••H	967	87.6	87.5	85.7	0.72	12.5	6.9	54.3	2.3	3.4	0.039	109	62
7.5	M3KP 160 MLA	3GKP 163 410-••H	965	87.2	88.4	88.2	0.81	15.3	6.5	74.2	1.9	3.0	0.088	226	57
11	M3KP 160 MLB	3GKP 163 420-••H	972	90.1	90.8	90.4	0.81	21.7	7.8	108	2.3	3.5	0.126	253	65
15	M3KP 180 MLB	3GKP 183 420-••H	972	90.4	91.0	90.4	0.82	29.2	7.2	147	1.9	3.2	0.25	304	58
18.5	M3KP 200 MLA	3GKP 203 410-••G	983	90.9	91.1	90.2	0.82	35.8	7.1	179	3.2	3.1	0.37	300	66
22	M3KP 200 MLB	3GKP 203 420-••G	983	91.6	91.9	91.0	0.82	42.2	7.5	213	3.2	3.2	0.43	320	61
30	M3KP 225 SMB	3GKP 223 220-••G	985	92.2	92.6	92.2	0.82	57.2	7.4	290	3.4	3.0	0.64	385	61
37	M3KP 250 SMA	3GKP 253 210-••G	987	93.1	93.4	92.8	0.81	70.8	7.2	357	3.2	2.9	1.16	455	66
45	M3KP 280 SMA	3GKP 283 210-••G	990	93.4	93.6	93.1	0.84	82.7	7.0	434	2.5	2.5	1.85	705	66
55	M3KP 280 SMB	3GKP 283 220-••G	990	93.8	94.0	93.3	0.84	100	7.0	530	2.7	2.6	2.2	745	66
75	M3KP 315 SMA	3GKP 313 210-••G	992	94.4	94.4	93.5	0.82	139	7.4	721	2.4	2.8	3.2	930	70
90	M3KP 315 SMB	3GKP 313 220-••G	992	94.8	94.8	94.2	0.84	163	7.5	866	2.4	2.8	4.1	1030	70
110	M3KP 315 SMC	3GKP 313 230-••G	991	95.0	95.0	94.6	0.83	201	7.4	1059	2.5	2.9	4.9	1100	70
132	M3KP 315 MLA	3GKP 313 410-••G	991	95.3	95.4	94.9	0.83	240	7.5	1271	2.7	3.0	5.8	1250	68
160	M3KP 355 SMA	3GKP 353 210-••G	993	95.4	95.4	94.8	0.83	291	7.0	1538	2.0	2.6	7.9	1630	75
200	M3KP 355 SMB	3GKP 353 220-••G	993	95.7	95.7	95.1	0.84	359	7.2	1923	2.2	2.7	9.7	1790	75
250	M3KP 355 SMC	3GKP 353 230-••G	993	95.7	95.7	95.1	0.83	454	7.4	2404	2.6	2.9	11.3	2010	75
315	M3KP 355 MLB	3GKP 353 420-••G	992	95.7	95.7	95.2	0.83	572	7.0	3032	2.5	2.7	13.5	2370	75
355	M3KP 355 LKA	3GKP 353 810-••G	992	95.7	95.7	95.1	0.83	645	7.6	3417	2.7	2.9	15.5	2690	75
400	M3KP 400 LA	3GKP 403 510-••G	993	96.2	96.3	95.8	0.82	731	7.1	3846	2.3	2.7	17.0	3180	76
400	M3KP 400 LKA	3GKP 403 810-••G	993	96.2	96.3	95.8	0.82	731	7.1	3846	2.3	2.7	17.0	3180	76
450	M3KP 400 LB	3GKP 403 520-••G	994	96.6	96.6	96.1	0.82	819	7.4	4323	2.4	2.8	20.5	3430	76
450	M3KP 400 LKB	3GKP 403 820-••G	994	96.6	96.6	96.1	0.82	819	7.4	4323	2.4	2.8	20.5	3430	76
500	M3KP 400 LC	3GKP 403 530-••G	993	96.6	96.7	96.2	0.83	900	7.2	4808	2.5	2.7	22.0	3580	76
500	M3KP 400 LKC	3GKP 403 830-••G	993	96.6	96.7	96.2	0.83	900	7.2	4808	2.5	2.7	22.0	3580	76
560	M3KP 400 LD	3GKP 403 540-••G	993	96.9	96.9	96.4	0.85	981	7.4	5385	2.4	2.8	24.0	3680	77
560	M3KP 400 LKD	3GKP 403 840-••G	993	96.9	96.9	96.4	0.85	981	7.4	5385	2.4	2.8	24.0	3680	77
1000 r/min = 6-poles 400 V 50 Hz			High-output design												
14	^{1) 2)} M3KP 160 MLC	3GKP 163 430-••H	969	89.2	89.4	88.0	0.75	30.2	7.9	137	2.8	3.9	0.126	253	64
18.5	²⁾ M3KP 180 MLC	3GKP 183 430-••H	975	90.1	90.2	88.7	0.74	40.0	7.2	181	2.0	3.2	0.25	304	61
30	²⁾ M3KP 200 MLC	3GKP 203 430-••G	983	91.6	91.7	90.5	0.80	59.0	7.5	291	3.5	3.4	0.49	340	65
37	²⁾ M3KP 225 SMC	3GKP 223 230-••G	983	92.1	92.5	92.1	0.83	69.8	7.1	359	3.0	2.8	0.75	415	64
45	M3KP 250 SMB	3GKP 253 220-••G	986	93.1	93.3	92.6	0.82	85.0	7.2	435	3.3	2.8	1.49	500	65
75	M3KP 280 SMC	3GKP 283 230-••G	990	94.2	94.5	94.1	0.84	136	7.3	723	2.8	2.7	2.85	825	66

¹⁾ Temperature rise class F
²⁾ Efficiency class IE1

The two bullets in the product code indicate choice of mounting arrangements, voltage and frequency code (see ordering information page).

I_s / I_N = Starting current
T_I / T_N = Locked rotor torque
T_b / T_N = Pull-out torque

Efficiency values are given according to IEC 60034-2-1; 2007. Please note that the values are not comparable without knowing the testing method. ABB has calculated the efficiency values according to indirect method, stray load losses (additional losses) determined from measuring.

Flameproof cast iron motors Ex de IIB/IIC T4

Technical data for totally enclosed squirrel cage three phase motors



IP 55 - IC 411 - Insulation class F, temperature rise class B

Output kW	Motor type	Product code	Speed r/min	Efficiency IEC 60034-2-1; 2007			Power factor cos φ	Current		Torque			Moment of inertia J = 1/4 GD ² kgm ²	Weight kg	Sound pressure level L _{PA} dB
				Full load 100%	3/4 load 75%	1/2 load 50%		I _N A	I _s I _N	T _N Nm	T _I T _N	T _b T _N			
750 r/min = 8-poles 400 V 50 Hz			CENELEC-design												
0.18	M3KP 80 MA	3GKP 084 310-••H	720	61.0	56.4	48.3	0.48	0.88	3.3	2.3	3.7	4.0	0.0022	38	36
0.25	M3KP 80 MB	3GKP 084 320-••H	705	63.8	61.1	54.6	0.58	0.97	3.2	3.3	2.6	2.8	0.0022	38	36
0.37	M3KP 90 SLA	3GKP 094 010-••H	696	67.9	67.9	63.9	0.63	1.24	3.0	5.0	2.0	2.2	0.0036	50	36
0.55	M3KP 90 SLC	3GKP 094 030-••H	695	68.7	68.5	64.4	0.61	1.89	3.1	7.5	2.2	2.4	0.0037	52	36
0.75	M3KP 100 LA	3GKP 104 510-••H	720	75.9	74.1	69.1	0.59	2.4	3.8	9.9	2.0	2.9	0.012	69	54
1.1	M3KP 100 LB	3GKP 104 520-••H	717	76.4	74.9	70.2	0.57	3.6	3.7	14.6	2.1	2.9	0.012	69	54
1.5	M3KP 112 MC	3GKP 114 330-••H	713	77.2	76.4	72.4	0.59	4.7	3.5	20.0	2.0	2.7	0.014	73	54
2.2	M3KP 132 SMC	3GKP 134 230-••H	720	80.1	79.8	76.7	0.65	6.0	4.7	29.1	2.0	2.9	0.034	107	59
3	M3KP 132 SMD	3GKP 134 240-••H	710	79.9	81.5	80.6	0.70	7.7	4.1	40.3	1.7	2.3	0.036	109	59
4	M3KP 160 MLA	3GKP 164 410-••H	722	86.7	87.4	86.6	0.71	9.3	5.4	52.9	1.7	2.8	0.133	251	59
5.5	M3KP 160 MLB	3GKP 164 420-••H	723	86.8	87.6	86.8	0.71	12.8	5.8	72.6	1.9	3.1	0.133	251	53
7.5	M3KP 160 MLC	3GKP 164 430-••H	718	85.5	86.3	85.5	0.70	18.0	5.7	99.7	2.1	3.1	0.133	251	55
11	M3KP 180 MLB	3GKP 184 420-••H	723	88.3	89.2	88.7	0.72	24.9	5.7	145	1.7	2.7	0.245	298	63
15	M3KP 200 MLA	3GKP 204 410-••G	734	89.9	90.3	89.6	0.79	30.4	7.0	195	2.4	3.2	0.45	315	56
18.5	M3KP 225 SMA	3GKP 224 210-••G	734	90.0	90.3	89.3	0.74	40.0	6.1	240	2.2	3.0	0.61	370	55
22	M3KP 225 SMB	3GKP 224 220-••G	732	90.6	91.2	90.6	0.77	45.5	6.5	287	2.2	2.9	0.68	385	56
30	M3KP 250 SMA	3GKP 254 210-••G	735	91.4	91.2	90.7	0.78	60.7	6.7	389	2.0	2.9	1.25	455	56
37	M3KP 280 SMA	3GKP 284 210-••G	741	92.7	92.7	91.6	0.78	73.8	7.3	476	1.7	3.0	1.85	705	65
45	M3KP 280 SMB	3GKP 284 220-••G	741	93.2	93.2	92.2	0.78	89.3	7.6	579	1.8	3.1	2.2	745	65
55	M3KP 315 SMA	3GKP 314 210-••G	742	93.4	93.5	92.7	0.81	104	7.1	707	1.6	2.7	3.2	930	62
75	M3KP 315 SMB	3GKP 314 220-••G	741	93.7	93.9	93.4	0.82	140	7.1	966	1.7	2.7	4.1	1030	62
90	M3KP 315 SMC	3GKP 314 230-••G	741	94.0	94.2	93.6	0.82	168	7.4	1159	1.8	2.7	4.9	1100	64
110	M3KP 315 MLA	3GKP 314 410-••G	740	94.0	94.3	94.0	0.83	203	7.3	1419	1.8	2.7	5.8	1250	72
132	M3KP 355 SMA	3GKP 354 210-••G	744	94.7	94.7	94.0	0.80	251	7.5	1694	1.5	2.6	7.9	1630	69
160	M3KP 355 SMB	3GKP 354 220-••G	744	95.2	95.2	94.5	0.80	303	7.6	2053	1.6	2.6	9.7	1790	69
200	M3KP 355 SMC	3GKP 354 230-••G	743	95.3	95.4	94.8	0.80	378	7.4	2570	1.6	2.6	11.3	1930	69
250	M3KP 355 MLB	3GKP 354 420-••G	743	95.4	95.5	95.0	0.80	472	7.5	3213	1.6	2.7	13.5	2370	72
315	M3KP 400 LA	3GKP 404 510-••G	744	96.1	96.2	95.8	0.81	584	7.0	4043	1.2	2.6	17.0	3180	71
315	M3KP 400 LKA	3GKP 404 810-••G	744	96.1	96.2	95.8	0.81	584	7.0	4043	1.2	2.6	17.0	3180	71
355	M3KP 400 LB	3GKP 404 520-••G	743	96.2	96.3	96.1	0.83	641	6.8	4562	1.2	2.5	21.0	3480	71
355	M3KP 400 LKB	3GKP 404 820-••G	743	96.2	96.3	96.1	0.83	641	6.8	4562	1.2	2.5	21.0	3480	71
400	M3KP 400 LC	3GKP 404 530-••G	744	96.3	96.4	96.0	0.82	731	7.4	5134	1.3	2.7	24.0	3680	71
400	M3KP 400 LKC	3GKP 404 830-••G	744	96.3	96.4	96.0	0.82	731	7.4	5134	1.3	2.7	24.0	3680	71
750 r/min = 8-poles 400 V 50 Hz			High-output design												
18.5	M3KP 200 MLB	3GKP 204 420-••G	734	89.8	90.2	89.6	0.80	37.1	6.9	240	2.2	3.2	0.54	335	57
30	M3KP 225 SMC	3GKP 224 230-••G	731	90.7	91.5	91.3	0.78	61.2	6.3	391	2.3	3.0	0.75	410	59
37	M3KP 250 SMB	3GKP 254 220-••G	737	92.2	91.7	91.0	0.78	74.2	7.5	479	2.3	3.4	1.52	500	59
55	M3KP 280 SMC	3GKP 284 230-••G	741	93.4	93.5	92.8	0.80	106	7.9	708	1.9	3.1	2.85	825	65

The two bullets in the product code indicate choice of mounting arrangements, voltage and frequency code (see ordering information page).

I_s / I_N = Starting current
T_I / T_N = Locked rotor torque
T_b / T_N = Pull-out torque

Efficiency values are given according to IEC 60034-2-1; 2007. Please note that the values are not comparable without knowing the testing method. ABB has calculated the efficiency values according to indirect method, stray load losses (additional losses) determined from measuring.

Flameproof motors Ex de variant codes

Code ¹⁾	Variant	Frame Size													
		80	90	100	112	132	160	180	200	225	250	280	315	355	400
Administration															
531	Sea freight packing	M	M	M	M	M	M	M	M	M	M	M	P	P	P
Balancing															
417	Vibration acc. to Grade B (IEC 60034-14).	P	P	P	P	P	P	P	P	P	P	P	P	P	P
423	Balanced without key	P	P	P	P	P	P	P	P	P	P	P	P	P	P
424	Full key balancing.	P	P	P	P	P	P	P	P	P	P	P	P	P	P
Bearings and Lubrication															
036	Transport lock for bearings.	NA	NA	NA	NA	NA	NA	NA	NA	NA	NA	P	P	P	P
037	Roller bearing at D-end.	NA	NA	NA	NA	NA	M	M	M	M	M	M	P	NA	NA
040	Heat resistant grease.	S	S	S	S	S	P	P	P	P	P	P	P	P	P
041	Bearings regreasable via grease nipples.	NA	NA	NA	NA	NA	S	S	S	S	S	S	S	S	S
043	SPM compatible nipples for vibration measurement	NA	NA	NA	NA	NA	S	S	S	S	S	S	S	S	S
058	Angular contact bearing at D-end, shaft force away from bearing.	NA	NA	NA	NA	NA	NA	NA	NA	NA	NA	P	P	P	P
107	Pt100 2-wire in bearings.	NA	NA	NA	NA	NA	P	P	P	P	P	P	P	P	P
128	Double PT100, 2-wire in bearings	NA	NA	NA	NA	NA	P	P	P	P	P	P	P	P	P
129	Double PT100, 3-wire in bearings	NA	NA	NA	NA	NA	P	P	P	P	P	P	P	P	P
130	Pt100 3-wire in bearings.	NA	NA	NA	NA	NA	P	P	P	P	P	P	P	P	P
194	2Z bearings greased for life at both ends.	S	S	S	S	S	M	M	M	M	M	NA	NA	NA	NA
433	Outlet grease collector	NA	NA	NA	NA	NA	NA	NA	NA	NA	NA	P	P	P	P
506	Nipples for vibration measurement : SKF Marlin Quick Connect stud CMSS-2600-3	NA	NA	NA	NA	NA	P	P	P	P	P	P	P	P	P
654	Provision for vibration sensors (M8x1)	NA	NA	NA	NA	NA	P	P	P	P	P	P	P	P	P
795	Lubrication information plate	NA	NA	NA	NA	NA	M	M	M	M	M	S	S	S	S
796	Grease nipples JIS B 1575 PT 1/8 Type A	NA	NA	NA	NA	NA	P	P	P	P	P	P	P	P	P
797	Stainless steel SPM Nipples	NA	NA	NA	NA	NA	P	P	P	P	P	P	P	P	P
798	Stainless steel grease nipples	NA	NA	NA	NA	NA	P	P	P	P	P	P	P	P	P
799	Grease nipples flat type DIN 3404, thread M10x1	NA	NA	NA	NA	NA	M	M	M	M	M	M	P	P	P
800	Grease nipples JIS B 1575 PT 1/8" pin type	NA	NA	NA	NA	NA	P	P	P	P	P	P	P	P	P
Branch standard designs															
178	Stainless steel / acid proof bolts.	S	S	S	S	S	M	M	M	M	M	M	P	P	P
204	Jacking bolts for foot mounted motors.	NA	NA	NA	NA	NA	P	P	P	P	P	P	P	S	S
209	Non-standard voltage or frequency, (special winding).	P	P	P	P	P	P	P	P	P	P	P	P	P	P
396	Motor designed for ambient temperature -20°C to -40°C, with space heaters (code 450/451 must be added).	P	P	P	P	P	P	P	P	P	P	P	P	P	P
397	Motor designed for ambient temperature -40°C to -55°C, with space heaters (code 450/451 must be added).	P	P	P	P	P	P	P	P	P	P	P	P	P	P
398	Motor designed for ambient temperature -20°C to -40°C.	P	P	P	P	P	P	P	P	P	P	P	P	P	P
399	Motor designed for ambient temperature -40°C to -55°C.	P	P	P	P	P	P	P	P	P	P	P	P	P	P

¹⁾ Certain variant codes cannot be used simultaneously.

S = Included as standard
P = New manufacture only
M = On modification of a stocked motor; or on new manufacture, the number of number per order may be limited.
R = On request
NA = Not applicable.

Code ¹⁾	Variant	Frame Size													
		80	90	100	112	132	160	180	200	225	250	280	315	355	400
425	Corrosion protected stator and rotor core.	S	S	S	S	S	S	S	S	S	S	P	P	P	P
786	Special design shaft upwards (V3, V36, V6) for outdoor mounting.	P	P	P	P	P	P	P	P	P	P	R	R	NA	NA
Cooling system															
044	Unidirectional fan for reduced noise level. Rotation clockwise seen from D-end. Available only for 2-pole motors.	NA	NA	NA	NA	NA	NA	NA	NA	NA	NA	P	P	P	S
045	Unidirectional fan for reduced noise level. Rotation counter clockwise seen from D-end. Available only for 2-pole motors.	NA	NA	NA	NA	NA	NA	NA	NA	NA	NA	P	P	P	S
068	Light alloy metal fan	M	M	M	M	M	M	M	M	M	M	M	P	P	P
183	Separate motor cooling (fan axial, N-end).	NA	NA	NA	NA	NA	P	P	P	P	P	P	P	P	P
206	Steel fan	NA	NA	NA	NA	NA	P	P	P	P	P	P	P	P	P
422	Separate motor cooling (fan top, N-end).	NA	NA	NA	NA	NA	NA	NA	NA	NA	NA	P	P	P	P
791	Stainless steel fan cover	NA	NA	NA	NA	NA	NA	NA	NA	P	P	P	P	P	P
Coupling															
035	Assembly of customer supplied coupling-half.	NA	NA	NA	NA	NA	NA	NA	NA	NA	NA	P	P	P	P
Documentation															
141	Binding dimension drawing.	M	M	M	M	M	M	M	M	M	M	M	P	P	P
Drain holes															
448	Draining holes with metal plugs.	NA	NA	NA	NA	NA	P	P	P	P	P	P	P	P	P
Earthing Bolt															
067	External earthing bolt.	S	S	S	S	S	S	S	S	S	S	S	S	S	S
Hazardous Environments															
452	DIP/Ex tD acc. to ATEX directive 94/9/EC, T= 125 °C, cat. 3D, IP55	M	M	M	M	M	NA	NA	M	M	M	M	P	P	P
453	DIP/Ex tD acc. to ATEX directive 94/9/EC, T= 125 °C, cat. 2D, IP65	M	M	M	M	M	M	M	M	M	M	M	P	P	P
454	DIP/Ex tD acc. to ATEX directive 94/9/EC, T= 125 °C, cat. 3D, IP65	M	M	M	M	M	NA	NA	M	M	M	M	P	P	P
461	Ex d(e) design, Group II C	M	M	M	M	M	M	M	M	M	M	P	P	P	P
462	Ex d(e) design, temperature class T5.	R	R	R	R	R	R	R	R	R	R	R	R	R	R
463	Ex d(e) design, temperature class T6.	R	R	R	R	R	R	R	R	R	R	NA	NA	NA	NA
464	Alleinschutz' design. Certification of flame proof motor and protection device together.	P	P	P	P	P	P	P	P	P	P	P	R	R	R
812	Explosion protection according to IEC-standards.	M	M	M	M	M	M	M	M	M	M	M	P	P	P
813	Thermistor-based surface temperature protection T4 for frequency convertor duty.	M	M	M	M	M	M	M	M	M	M	M	P	P	P
814	Ex tD (DIP) motors, temperature class T 150C.	M	M	M	M	M	M	M	M	M	M	M	P	P	P
816	Pt-100-based surface temperature protection T4 for frequency convertor duty. 3-wire system.	NA	NA	NA	NA	NA	P	P	P	P	P	P	P	P	P
Heating elements															
450	Heating element, 100-120V.	M	M	M	M	M	M	M	M	M	M	M	P	P	P
451	Heating element, 200-240V.	M	M	M	M	M	M	M	M	M	M	M	P	P	P

¹⁾ Certain variant codes cannot be used simultaneously.

S = Included as standard
P = New manufacture only
M = On modification of a stocked motor; or on new manufacture, the number of number per order may be limited.
R = On request
NA = Not applicable.

Code ¹⁾	Variant	Frame Size													
		80	90	100	112	132	160	180	200	225	250	280	315	355	400
Insulation system															
014	Winding insulation class H.	P	P	P	P	P	P	P	P	P	P	P	P	P	P
405	Special winding insulation for frequency converter supply.	P	P	P	P	P	P	P	P	P	P	P	P	P	P
Mounting arrangements															
007	IM 3001 flange mounted, IEC flange, from IM 1001 (B5 from B3).	M	M	M	M	M	NA	NA	NA	NA	NA	NA	NA	NA	NA
008	IM 2101 foot/flange mounted, IEC flange, from IM 1001 (B34 from B3).	M	M	M	M	M	NA	NA	NA	NA	NA	NA	NA	NA	NA
009	IM 2001 foot/flange mounted, IEC flange, from IM 1001 (B35 from B3).	M	M	M	M	M	M	M	M	M	M	P	P	P	
047	IM 3601 flange mounted, IEC flange, from IM 3001 (B14 from B5).	M	M	M	M	M	NA	NA	NA	NA	NA	NA	NA	NA	NA
066	Modified for non-standard mounting position (please specify IM xxxx), (must be ordered for all mounting arrangements excluding IM B3 (1001), IM B5 (3001), IM B35 (2001), B34 (2101) & B14 (3601).	M	M	M	M	M	M	M	M	M	M	M	P	P	P
093	IM 3601 flange mounted, IEC flange, from IM 1001 (B14 from B3).	M	M	M	M	M	NA	NA	NA	NA	NA	NA	NA	NA	NA
228	Flange FF 130.	M	M	M	M	NA	NA	NA	NA	NA	NA	NA	NA	NA	NA
229	Flange FT 130.	M	M	M	M	NA	NA	NA	NA	NA	NA	NA	NA	NA	NA
235	Flange FF 165.	S	M	M	M	M	NA	NA	NA	NA	NA	NA	NA	NA	NA
236	Flange FT 165.	NA	M	M	M	M	NA	NA	NA	NA	NA	NA	NA	NA	NA
245	Flange FF 215.	NA	NA	S	S	M	NA	NA	NA	NA	NA	NA	NA	NA	NA
246	Flange FT 215.	NA	NA	M	M	M	NA	NA	NA	NA	NA	NA	NA	NA	NA
255	Flange FF 265.	NA	NA	NA	NA	S	NA	NA	NA	NA	NA	NA	NA	NA	NA
256	Flange FT 265.	NA	NA	NA	NA	M	NA	NA	NA	NA	NA	NA	NA	NA	NA
257	Flange FF 100.	M	NA	NA	NA	NA	NA	NA	NA	NA	NA	NA	NA	NA	NA
258	Flange FT 100.	M	NA	NA	NA	NA	NA	NA	NA	NA	NA	NA	NA	NA	NA
259	Flange FF 115.	M	M	NA	NA	NA	NA	NA	NA	NA	NA	NA	NA	NA	NA
260	Flange FT 115.	M	M	NA	NA	NA	NA	NA	NA	NA	NA	NA	NA	NA	NA
305	Additional lifting lugs.	NA	NA	NA	NA	NA	NA	NA	NA	NA	NA	P	P	P	P
309	IM 1001 foot mounted, from IM 3001 (B3 from B5).	M	M	M	M	M	M	M	NA	NA	NA	NA	NA	NA	NA
311	IM 2001 foot/flange mounted, IEC flange, from IM 3001 (B35 from B5).	M	M	M	M	M	NA	NA	NA	NA	NA	NA	NA	NA	NA
Painting															
111	Painting system C3M acc. to ISO 12944-5:2007	S	S	S	S	S	S	S	S	S	S	S	S	S	S
114	Special paint colour, standard grade.	M	M	M	M	M	M	M	M	M	M	M	P	P	P
115	Painting system C4M acc. to ISO 12944-5: 2007	P	P	P	P	P	P	P	P	P	P	P	P	P	P
168	Primer paint only.	P	P	P	P	P	P	P	P	P	P	P	P	P	P
754	Painting system C5M acc. to ISO 12944-5:2007	P	P	P	P	P	P	P	P	P	P	P	P	P	P
755	Aluminium metallizing and painting according to NORSOK M501 revision 5, Method 2A (only available color RAL 7038)	P	P	P	P	P	P	P	P	P	P	P	P	P	P

¹⁾ Certain variant codes cannot be used simultaneously.

S = Included as standard
P = New manufacture only
M = On modification of a stocked motor; or on new manufacture, the number of number per order may be limited.
R = On request
NA = Not applicable.

Code ¹⁾	Variant	Frame Size													
		80	90	100	112	132	160	180	200	225	250	280	315	355	400
Protection															
005	Metal protective roof, vertical motor, shaft down.	M	M	M	M	M	M	M	M	M	M	M	P	P	P
072	Radial seal at D-end.	M	M	M	M	M	M	M	M	M	M	P	P	NA	NA
073	Sealed against oil at D-end.	P	P	P	P	P	P	P	P	P	P	P	P	P	P
158	Degree of protection IP65.	M	M	M	M	M	M	M	M	M	M	M	P	P	P
401	Protective roof, horizontal motor.	P	P	P	P	P	P	P	P	P	P	P	P	P	P
403	Degree of protection IP56.	M	M	M	M	M	M	M	M	M	M	M	P	P	P
434	Degree of protection IP56, open deck.	NA	NA	NA	NA	NA	P	P	P	P	P	P	P	P	P
783	Labyrinth sealing at D-end.	P	P	P	P	P	P	P	P	P	P	P	P	S	S
Rating & instruction plates															
002	Restamping voltage, frequency and output, continuous duty.	M	M	M	M	M	M	M	M	M	M	M	P	P	P
004	Additional text on std rating plate (max 12 digits on free text line).	P	P	P	P	P	P	P	P	P	P	P	P	P	P
095	Restamping output (maintained voltage, frequency), intermittent duty.	M	M	M	M	M	M	M	M	M	M	M	P	P	P
126	Tag plate	P	P	P	P	P	P	P	P	P	P	P	P	P	P
135	Mounting of additional identification plate, stainless.	M	M	M	M	M	M	M	M	M	M	M	P	P	P
139	Additional identification plate delivered loose.	M	M	M	M	M	M	M	M	M	M	M	P	P	P
161	Additional rating plate delivered loose.	M	M	M	M	M	M	M	M	M	M	M	P	P	P
163	Frequency converter rating plate. Rating data according to quotation.	M	M	M	M	M	M	M	M	M	M	M	P	P	P
Shaft & rotor															
069	Two shaft extensions as per basic catalogue.	P	P	P	P	P	P	P	P	P	P	P	P	P	P
070	One or two special shaft extensions, standard shaft material.	P	P	P	P	P	P	P	P	P	P	P	P	P	P
164	Shaft extension with closed key-way.	S	S	S	S	S	S	S	S	S	S	P	P	P	P
165	Shaft extension with open key-way.	P	P	P	P	P	P	P	P	P	P	S	S	S	S
410	Stainless steel shaft (standard or non-standard design).	R	R	R	R	R	R	R	R	R	R	P	P	P	P
Standards and Regulations															
151	Design according to SHELL DEP 33.66.05.31-Gen. June 2007	M	M	M	M	M	M	M	M	M	M	P	P	P	P
540	China energy label	M	M	M	M	M	M	M	M	M	M	M	M	M	NA
774	Design according to NOROK (Norwegian Territorial Waters)excluding surface treatment.	P	P	P	P	P	P	P	P	P	P	P	P	P	P
775	Design according to SHELL DEP 33.66.05.31-Gen. January 1999 design.	M	M	M	M	M	M	M	M	M	M	M	P	P	P
778	GOST Export/Import Certificate (Russia).	P	P	P	P	P	P	P	P	P	P	M	P	P	P
779	SASO Export/Import Certificate (Saudi Arabia)	M	M	M	M	M	M	M	M	M	M	M	P	P	P
782	Fulfilling CQST Certification requirements (China)	M	M	M	M	M	M	M	M	M	M	M	P	P	P
788	Documentation for Korean KOSHA certification (must be ordered with variant code 812)	M	M	M	M	M	M	M	M	M	M	M	P	P	P
802	GOST Kazakhstan certified	P	P	P	P	P	P	P	P	P	P	P	P	P	NA

¹⁾ Certain variant codes cannot be used simultaneously.

S = Included as standard
P = New manufacture only
M = On modification of a stocked motor; or on new manufacture, the number of number per order may be limited.
R = On request
NA = Not applicable.

Code ¹⁾	Variant	Frame Size													
		80	90	100	112	132	160	180	200	225	250	280	315	355	400
Stator winding temperature sensors															
120	KTY 84-130 (1 per phase) in stator winding.	P	P	P	P	P	P	P	P	P	P	P	P	P	P
121	Bimetal detectors, break type (NCC), (3 in series), 130°C, in stator winding.	P	P	P	P	P	P	P	P	P	P	P	P	P	P
122	Bimetal detectors, break type (NCC), (3 in series), 150°C, in stator winding.	P	P	P	P	P	P	P	P	P	P	P	P	P	P
123	Bimetal detectors, break type (NCC), (3 in series), 170°C, in stator winding.	NA	NA	NA	NA	NA	NA	NA	NA	NA	NA	P	P	P	P
125	Bimetal detectors, break type (NCC), (2x3 in series), 150°C, in stator winding.	P	P	P	P	P	P	P	P	P	P	P	P	P	P
127	Bimetal detectors, break type (NCC), (3 in series, 130°C & 3 in series, 150°C), in stator winding.	P	P	P	P	P	P	P	P	P	P	P	P	P	P
328	PTC - thermistors (3 in series), 120°C, in stator winding	M	M	M	M	M	M	M	M	M	M	M	P	P	P
435	PTC - thermistors (3 in series), 130°C, in stator winding.	M	M	M	M	M	M	M	M	M	M	M	P	P	P
436	PTC - thermistors (3 in series), 150°C, in stator winding.	S	S	S	S	S	S	S	S	S	S	S	S	S	S
439	PTC - thermistors (2x3 in series), 150°C, in stator winding.	M	M	M	M	M	M	M	M	M	M	M	P	P	P
441	PTC - thermistors (3 in series, 130°C & 3 in series, 150°C), in stator winding.	M	M	M	M	M	M	M	M	M	M	M	P	P	P
445	Pt-100 2-wire in stator winding, 1 per phase	P	P	P	P	P	P	P	P	P	P	P	P	P	P
446	Pt-100 2-wire in stator winding, 2 per phase	NA	NA	NA	NA	NA	P	P	P	P	P	P	P	P	P
502	Pt-100 3-wire in stator winding, 1 per phase.	NA	NA	NA	NA	NA	P	P	P	P	P	P	P	P	P
503	Pt-100 3-wire in stator winding, 2 per phase.	NA	NA	NA	NA	NA	P	P	P	P	P	P	P	P	P
Terminal box															
021	Terminal box LHS (seen from D-end).	NA	NA	NA	NA	NA	P	P	NA	NA	NA	NA	NA	NA	NA
022	Cable entry LHS (seen from D-end).	M	M	M	M	M	M	M	M	M	M	M	P	P	P
157	Terminal box degree of protection IP65.	M	M	M	M	M	M	M	M	M	M	M	P	P	P
180	Terminal box RHS (seen from D-end).	NA	NA	NA	NA	NA	P	P	NA	NA	NA	NA	NA	NA	NA
277	Cable sealing end unit, size small for C-opening	NA	NA	NA	NA	NA	NA	NA	NA	NA	NA	P	NA	NA	NA
278	Cable sealing end unit, size medium for D-opening	NA	NA	NA	NA	NA	NA	NA	NA	NA	NA	NA	P	P	P
279	Cable sealing end unit, size large for D-opening	NA	NA	NA	NA	NA	NA	NA	NA	NA	NA	NA	P	P	P
292	Adapter C-C	NA	NA	NA	NA	NA	NA	NA	NA	NA	NA	P	NA	NA	NA
293	Adapter D-D	NA	NA	NA	NA	NA	NA	NA	NA	NA	NA	NA	P	P	P
294	Adapter E-D	NA	NA	NA	NA	NA	NA	NA	NA	NA	NA	NA	P	P	P
295	Adapter E-2D	NA	NA	NA	NA	NA	NA	NA	NA	NA	NA	NA	P	P	P
300	Increased single core cross section	P	P	P	P	P	P	P	P	P	P	P	P	P	P
380	Separate terminal box for temperature detectors, std. material	NA	NA	NA	NA	NA	P	P	P	P	P	P	P	P	P
400	4 x 90 degr turnable terminal box.	S	S	S	S	S	S	S	S	S	S	S	S	NA	NA
402	Terminal box adapted for Al cables.	NA	NA	NA	NA	NA	NA	NA	NA	NA	NA	S	S	S	S

¹⁾ Certain variant codes cannot be used simultaneously.

S = Included as standard
P = New manufacture only
M = On modification of a stocked motor; or on new manufacture, the number of number per order may be limited.
R = On request
NA = Not applicable.

Code ¹⁾	Variant	Frame Size													
		80	90	100	112	132	160	180	200	225	250	280	315	355	400
413	Extended cable connection, no terminal box.	NA	NA	NA	NA	NA	P	P	P	P	P	P	P	P	P
418	Separate terminal box for auxiliaries, standard material.	NA	NA	NA	NA	NA	P	P	P	P	P	P	P	P	P
466	Terminal box at N-end.	NA	NA	NA	NA	NA	NA	NA	P	P	P	P	P	P	P
468	Cable entry from D-end.	M	M	M	M	M	M	M	M	M	M	M	P	P	P
469	Cable entry from N-end.	M	M	M	M	M	M	M	M	M	M	M	P	P	P
567	Separate terminal box material: Cast Iron	NA	NA	NA	NA	NA	P	P	P	P	P	P	P	P	P
568	Separate terminal box for heating elements, std. material	NA	NA	NA	NA	NA	P	P	P	P	P	P	P	P	P
569	Separate terminal box for brakes	NA	NA	NA	NA	NA	P	P	P	P	P	NA	NA	NA	NA
728	Standard cable gland, Ex d IIB, armoured cable, double sealing.	P	P	P	P	P	P	P	P	P	P	P	P	P	P
729	Aluminum non-drilled flange for cable glands	P	P	P	P	P	P	P	P	P	P	P	P	P	P
730	Prepared for NPT cable glands	P	P	P	P	P	P	P	P	P	P	P	P	P	P
732	Standard cable gland, Ex d IIB, armoured cable.	M	M	M	M	M	M	M	M	M	M	M	P	P	P
733	Standard cable gland, Ex d IIB, non-armoured cable.	M	M	M	M	M	M	M	M	M	M	M	P	P	P
734	Standard cable gland, Ex d IIC, armoured cable.	M	M	M	M	M	M	M	M	M	M	M	P	P	P
735	Standard cable gland, Ex d IIC, non-armoured cable.	M	M	M	M	M	M	M	M	M	M	M	P	P	P
736	Standard cable gland Ex e acc. to EN-standards.	S	S	S	S	S	S	S	S	S	S	S	S	S	S
737	Standard cable gland Ex e with clamping device acc. to EN-standards.	P	P	P	P	P	P	P	P	P	P	P	P	P	P
743	Painted non-drilled flange in steel for cable glands	M	M	M	M	M	M	M	M	M	M	M	P	P	P
744	Stainless steel non-drilled flange for cable glands.	M	M	M	M	M	M	M	M	M	M	M	P	P	P
745	Painted steel flange equipped with nickle plated brass cable glands	M	M	M	M	M	M	M	M	M	M	M	P	P	P
746	Stainless steel cable flange equipped with standard nickle plated brass cable glands	P	P	P	P	P	P	P	P	P	P	P	P	P	P

Testing

145	Type test report from a catalogue motor, 400V 50Hz.	M	M	M	M	M	M	M	M	M	M	M	P	P	P
146	Type test with report for one motor from specific delivery batch.	P	P	P	P	P	P	P	P	P	P	P	P	P	P
148	Routine test report.	M	M	M	M	M	M	M	M	M	M	M	P	P	P
150	Customer witnessed testing. Specify test procedure with other codes.	P	P	P	P	P	P	P	P	P	P	P	P	P	P
222	Torque/speed curve, type test and multi-point load test with report for one motor from specific delivery batch.	P	P	P	P	P	P	P	P	P	P	P	P	P	P
760	Vibration level test	M	M	M	M	M	M	M	M	M	M	M	P	P	P
761	Vibration spectrum test for one motor from specific delivery batch.	P	P	P	P	P	P	P	P	P	P	P	P	P	P

¹⁾ Certain variant codes cannot be used simultaneously.

S = Included as standard
P = New manufacture only
M = On modification of a stocked motor; or on new manufacture, the number of number per order may be limited.
R = On request
NA = Not applicable.

Code ¹⁾	Variant	Frame Size													
		80	90	100	112	132	160	180	200	225	250	280	315	355	400
762	Noise level test for one motor from specific delivery batch.	P	P	P	P	P	P	P	P	P	P	P	P	P	P
763	Noise spectrum test for one motor from specific delivery batch.	P	P	P	P	P	P	P	P	P	P	P	P	P	P
764	Test for one motor from specific delivery batch with ABB frequency converter available at ABB test field. ABB standard test procedure.	P	P	P	P	P	P	P	P	P	P	P	P	P	P

Variable speed drives

181	Rating plate with ABB standard loadability values for VSD operation. Other auxiliaries for VSD operation to be selected as necessary.	M	M	M	M	M	M	M	M	M	M	P	P	P	P
479	Mounting of other type of pulse tacho with shaft extension, tacho not included.	NA	NA	NA	NA	NA	P	P	P	P	P	P	P	P	P
680	2048 pulse tacho, Ex d, tD, L&L 841910001	NA	NA	NA	NA	NA	P	P	P	P	P	P	P	P	P
701	Insulated bearing at N-end.	NA	NA	NA	NA	NA	NA	NA	NA	NA	NA	M	P	P	P
704	EMC cable gland.	M	M	M	M	M	M	M	M	M	M	M	P	P	P
747	1024 pulse tacho, Ex d, tD, L&L 841910002	NA	NA	NA	NA	NA	P	P	P	P	P	P	P	P	P

Y/Δ starting

117	Terminals for Y/Δ start at both speeds (two speed windings).	NA	NA	NA	NA	NA	R	R	R	R	R	P	P	R	R
118	Terminals for Y/Δ start at high speed (two speed windings).	NA	NA	NA	NA	NA	R	R	R	R	R	P	P	R	R
119	Terminals for Y/Δ start at low speed (two speed windings).	NA	NA	NA	NA	NA	R	R	R	R	R	P	P	R	R

¹⁾ Certain variant codes cannot be used simultaneously.

S = Included as standard

P = New manufacture only

M = On modification of a stocked motor; or on new manufacture, the number of number per order may be limited.

R = On request

NA = Not applicable.

Flameproof motors

Dimension drawings, Ex de

Foot-mounted motor IM 1001, IM B3

Flange-mounted motor IM 3001, IM B5

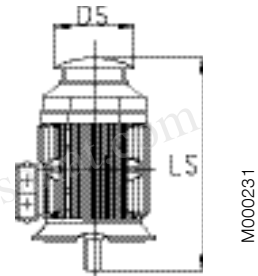
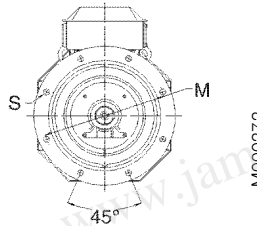
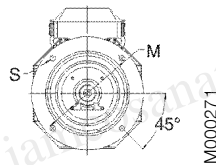
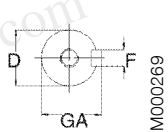
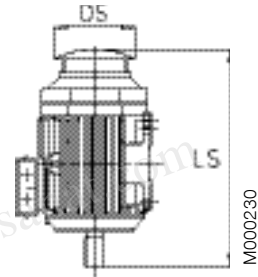
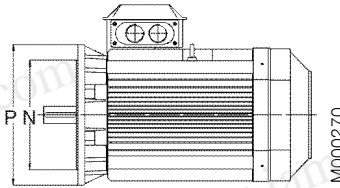
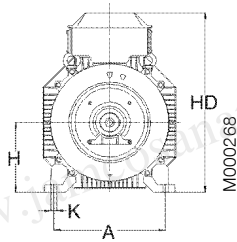
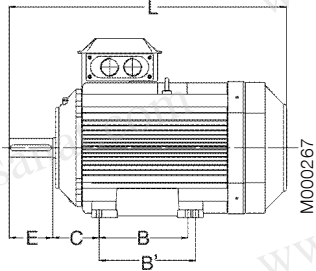

Sizes 71-200

Sizes 225-400

Protective roof,
variant code 005

Motor size	IM 1001, IM B3 AND IM 3001, IM B5										IM 1001, IM B3					IM 3001, IM B5					Protective roof				
	D		GA		F		E		L max		O	A	B	B'	C	HD	K	H	M	N	P	S	DS	LS	
	poles		poles		poles		poles		poles															poles	
	2	4-8	2	4-8	2	4-8	2	4-8	2	4-8														2	4-8
80	19	19	21.5	21.5	6	6	40	40	340	340	20	125	100	125	50	235	10	80	165	130	200	12	160	360	360
90	24	24	27	27	8	8	50	50	405	405	20	140	100	125	56	260	10	90	165	130	200	12	180	430	430
100	28	28	31	31	8	8	60	60	480	480	25	160	140	-	63	280	12	100	215	180	250	14.5	195	505	505
112	28	28	31	31	8	8	60	60	480	480	25	190	140	-	70	295	12	112	215	180	250	14.5	195	505	505
132	38	38	41	41	10	10	80	80	560	560	30	216	140	178	89	340	12	132	265	230	300	14.5	260	590	590
160	42	42	45	45	12	12	110	110	808	808	45	254	210	254	108	499	14.5	160	300	250	350	18.5	328	756	756
180	48	48	51.5	51.5	14	14	110	110	826	826	50	279	241	279	121	539	14.5	180	300	250	350	18.5	359	756	756
200	55	55	59	59	16	16	110	110	774	774	70	318	267	305	133	536	18.5	200	350	300	400	18.5	414	844	844
225	55	60	59	64	16	18	110	140	841	871	80	356	286	311	149	583	18.5	225	400	350	450	18.5	462	921	951
250	60	65	64	69	18	18	140	140	875	875	90	406	311	349	168	646	24	250	500	450	550	18.5	506	965	965
280	65	75	69	79.5	18	20	140	140	1088	1088	100	457	368	419	190	759	24	280	500	450	550	18	555	1190	1190
315 SM	65	80	69	85	18	22	140	170	1174	1204	115	508	406	457	216	852	30	315	600	550	660	23	624	1290	1320
315 ML	65	90	69	95	18	25	140	170	1285	1315	115	508	457	508	216	852	30	315	600	550	660	23	624	1401	1431
355 SM	70	100	62.5	90	20	28	140	210	1409	1479	130	610	500	560	254	958	35	355	740	680	800	23	720	1476	1546
355 ML	70	100	62.5	90	20	28	140	210	1514	1584	130	610	560	630	254	958	35	355	740	680	800	23	720	1528	1703
355 LK	70	100	62.5	90	20	28	140	210	1764	1834	130	610	710	900	254	958	35	355	740	680	800	23	720	1633	1703
400 L	80	110	85	126	22	28	170	210	1851	1891	150	710	900	1000	224	1045	35	400	940	880	1000	28	810	1860	1900
400 LK	80	100	85	106	22	28	170	210	1851	1891	150	686	710	800	280	1045	35	400	740	680	800	24	810	1860	1900
450	80	120	85	127	22	32	170	210	2147	2187	180	800	1000	1120	250	1169	42	450	1080	1000	1150	28	On request		

IM 3601, IM B14 - Available flange alternatives, see also variant codes

Flange size	Variant code	Flange dimensions				Motor sizes 80-132					S = Standard M = Modification NA = Not possible
		P	M	N	S	80	90	100	112	132	
FF100	258	120	100	80	M6	S	NA	NA	NA	NA	S = Standard
FF115	260	140	115	95	M8	M	S	NA	NA	NA	M = Modification
FF130	229	160	130	110	M8	M	M	S	S	NA	NA = Not possible
FF165	236	200	165	130	M10	NA	NA	NA	NA	S	
FF215	246	250	215	180	M12	NA	NA	M	M	M	
FF265	256	300	265	230	M12	NA	NA	NA	NA	M	
FT100	257	120	100	80	M7	S	M	NA	NA	NA	
FT115	259	140	115	95	M10	M	S	NA	NA	NA	
FT130	228	160	130	110	M10	M	M	S	S	NA	
FT165	235	200	165	130	M12	M	M	M	M	S	
FT215	245	250	215	180	M14.5	NA	NA	M	M	M	
FT265	255	300	265	230	M14.5	NA	NA	NA	NA	M	

Tolerances:

- A, B ± 0.8
- D, DA ISO k6 < Ø 50mm
ISO m6 > Ø 50mm
- F, FA ISO h9
- H -0.5
- N ISO j6
- C, CA ± 0.8

Above table gives the main dimensions in mm. For detailed drawings please see our web-pages www.abb.com/motors&generators or contact ABB.

Flameproof motor construction Ex de

Typical exploded view of cast iron motors, frame size 315

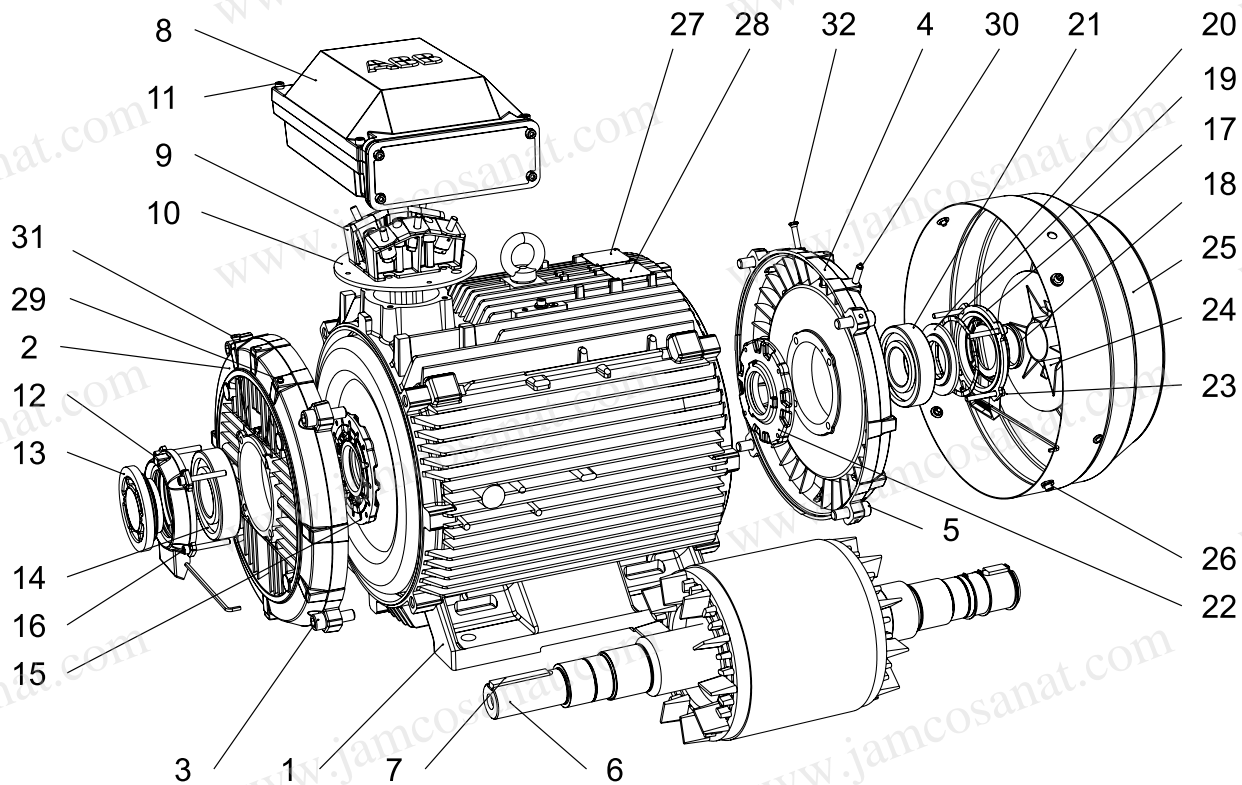

- | | | | |
|----|--|----|---------------------------------|
| 1 | Stator frame | 17 | Outer bearing cover, N-end |
| 2 | Endshield, D-end | 18 | Seal, N-end |
| 3 | Screws for endshield, D-end | 19 | Wave spring |
| 4 | Endshield, N-end | 20 | Valve disc, N-end |
| 5 | Screws for endshield, N-end | 21 | Bearing, N-end |
| 6 | Rotor with shaft | 22 | Inner bearing cover, N-end |
| 7 | Key, D-end | 23 | Screws for bearing cover, N-end |
| 8 | Terminal box | 24 | Fan |
| 9 | Terminal board | 25 | Fan cover |
| 10 | Intermediate flange | 26 | Screws for fan cover |
| 11 | Screws for terminal box cover | 27 | Rating plate |
| 12 | Outer bearing cover, D-end | 28 | Regreasing plate |
| 13 | Valve disc with labyrinth seal, D-end;
standard in 2-pole motors (V-ring in 4-8 pole) | 29 | Grease nipple, D-end |
| 14 | Bearing, D-end | 30 | Grease nipple, N-end |
| 15 | Inner bearing cover, D-end | 31 | SPM nipple, D-end |
| 16 | Screws for bearing cover, D-end | 32 | SPM nipple, N-end |

M000220

Certificate examples



IECEx Certificate of Conformity

INTERNATIONAL ELECTROTECHNICAL COMMISSION
IEC Certification Scheme for Explosive Atmospheres
for rules and details of the IECEx Scheme visit www.iecex.com

Certificate No.: IECEx LCI 09.0000X	Issue No.: 1	Certificate history: Issue No. 1 (2009-3-19) Issue No. 0 (2009-2-02)
Status: Current	Page 1 of 5	
Date of Issue: 2009-03-19		
Applicant: ABB Oy Motors Strömbergin Puistotie 5A FIN - 65101 VAASA Finland		
Electrical Apparatus: Optional accessory: Asynchronous motor - M3JPK/PJK/C 160 ... (Generation H)		
Type of Protection: d or de and/or Td		
Marking: Ex dIle IIB/C T3 to T6 Ex ID A21 T85°C to T150°C		
Approved for issue on behalf of the IECEx Certification Body: Signature:  Position: Ex Certification Manager		
Date: 28.04.2009	Marc GILLAUX	
<p>1. This certificate and schedule may only be reproduced in full. 2. This certificate is not transferable and remains the property of the issuing body. 3. The status and authenticity of this certificate may be verified by visiting the Official IECEx Website.</p>		
<p>Certificate issued by: Laboratoire Central des Industries Electriques (LCIE) 33 Avenue du General Leclerc FR-92260 Fontenay-aux-Roses France</p> 		

M000726

L C I E

<p>1 ATTESTATION D'EXAMEN CE DE TYPE</p> <p>2 Appareil ou système de protection destiné à être utilisé en atmosphères explosibles (Directive 94/9/CE)</p> <p>3 Numéro de l'attestation d'examen CE de type LCIE 09 ATEX 3005 X</p> <p>4 Appareil ou système de protection : Type : M3JP180 ... M3KP180 ... M3JC180 ... M3KC180 ... (Génération H)</p> <p>5 Demandeur : ABB Oy Motors Adresse : Strömbergin Puistotie 5A FIN - 65101 VAASA - Finland</p> <p>6 Fabricant : ABB Oy Motors Adresse : Strömbergin Puistotie 5A FIN - 65101 VAASA - Finland</p> <p>7 Cet appareil ou système de protection et ses variantes éventuelles acceptées sont décrits dans l'annexe de la présente attestation et dans les documents descriptifs cités en référence.</p> <p>8 La LCIE, organisme notifié sous la référence 0081 conformément à l'article 9 de la directive 94/9/CE du Parlement européen et du Conseil du 23 mars 1994, certifie que cet appareil ou système de protection est conforme aux exigences essentielles de sécurité et de santé pour la conception et la construction d'appareils et de systèmes de protection destinés à être utilisés en atmosphères explosibles, données dans l'annexe II de la directive. Les résultats des vérifications et essais figurent dans le rapport confidentiel N° 86287-577197-02.</p> <p>9 Le respect des exigences essentielles de sécurité et de santé est assuré par la conformité à : - EN 60079-0 (2006) - EN 61241-0 (2006) - EN 60079-1 (2007) - EN 61241-1 (2006) - EN 60079-7 (2007)</p> <p>10 Le signe X lorsqu'il est placé à la suite du numéro de l'attestation, indique que cet appareil ou système de protection est soumis aux conditions spéciales pour une utilisation sûre, mentionnées dans l'annexe de la présente attestation.</p> <p>11 Cette attestation d'examen CE de type concerne uniquement la conception et la construction de l'appareil ou du système de protection spécifié, conformément à l'annexe III de la directive 94/9/CE. Des exigences supplémentaires de la directive sont applicables pour la fabrication et la fourniture de l'appareil ou du système de protection. Ces dernières ne sont pas couvertes par la présente attestation.</p> <p>12 Le marquage de l'appareil ou du système de protection doit comporter les informations détaillées au point 15.</p>	<p>1 EC TYPE EXAMINATION CERTIFICATE</p> <p>2 Equipment or protective system intended for use in potentially explosive atmospheres (Directive 94/9/EC)</p> <p>3 EC type examination certificate number LCIE 09 ATEX 3005 X</p> <p>4 Equipment or protective system : Type : M3JP180 ... M3KP180 ... M3JC180 ... M3KC180 ... (Generation H)</p> <p>5 Applicant : ABB Oy Motors Address : Strömbergin Puistotie 5A FIN - 65101 VAASA - Finland</p> <p>6 Manufacturer : ABB Oy Motors Address : Strömbergin Puistotie 5A FIN - 65101 VAASA - Finland</p> <p>7 This equipment or protective system and any acceptable variation thereof are specified in the schedule to this certificate and the documents therein referred to.</p> <p>8 LCIE, notified body number 0081 in accordance with article 9 of the Directive 94/9/EC of the European Parliament and the Council of 23 March 1994, certifies that this equipment or protective system has been found to comply with the essential Health and Safety Requirements relating to the design and construction of equipment and protective systems intended for use in potentially explosive atmospheres, given in Annex II of the Directive. The examination and test results are recorded in confidential report N° 86287-577197-02.</p> <p>9 Compliance with the Essential Health and Safety Requirements has been assured by compliance with : - EN 60079-0 (2006) - EN 61241-0 (2006) - EN 60079-1 (2007) - EN 61241-1 (2004) - EN 60079-7 (2007)</p> <p>10 If the sign X is placed after the certificate number, it indicates that the equipment or protective system is subject to special conditions for safe use specified in the schedule to this certificate.</p> <p>11 This EC type examination certificate relates only to the design and construction of this specified equipment or protective system in accordance with annex III to the directive 94/9/EC. Further requirements of the directive apply to the manufacturing process and supply of this equipment or protective system. These are not covered by this certificate.</p> <p>12 The marking of the equipment or protective system shall comport the information as detailed at 15.</p>
---	--

Fontenay-aux-Roses, le 23 Février 2009





Responsible for certification ATEX
XS PHAM

Seul le texte en français peut engager la responsabilité de LCIE. Ce document ne peut être reproduit ou diffusé sans autorisation. The LCIE's liability applies only on the French text. This document may only be reproduced or disseminated without any change.

Page 1 of 4
01 Annex LCIE_09_A09_1605-00C

M000729

EC Declaration of Conformity

The Manufacturer: ABB Oy Motors
P.O. Box 633
Strömbergin puistotie 5A
FIN - 65101 Vaasa, Finland

hereby declares that

the products: 3-phase induction motors, series M2GP, M3JP, M3JC, M3KP, M3KC, M3GP, M3HP and M3PLP, as listed on page 2 in this document, fulfil provisions of the relevant Council Directives:

Directive 94/9/EC (ATEX of 23rd March 1994)

by applying the following harmonized standards:
EN 60079-0 (2006), EN 60079-1 (2007), EN 60079-7 (2007), EN 60079-15 (2005), EN 61241-0 (2006), EN 61241-1 (2004).

ABB Oy Motors declare on it's sole responsibility,

- that the state of the art of these standards do not modify the result of the assessment carried out by LCIE which issued the EC type examination certificates according to former editions of the standard series.

- that listed motors conform to the requirements of annex II of the directive 94/9/EC clause 1.2.7 by applying the standards serie EN 60034.

Directive 2005/32/EC (EuP of 6th July 2005)

by fulfilling the requirements of the standard EN 60034-30 (March 2009) in respect of the efficiency class.

Note: When installing motors for converter supply applications additional requirements must be respected regarding the motor as well as the installation, as described in the appropriate dedicated addendum.

Signed by: 



Jouni Ikäheimo
Product Development Manager

Date: April 29th, 2010 3GZF500930-988

ABB Oy

Motors	Postal address	Telephone	Internet	Business Identity Code:
FINLAND	FINLAND	+358 10 22 11	www.abb.fi	0763403-0
	FINLAND	+358 10 22 47372	e-mail: first name.last name@fi.abb.com	Domicile: Helsinki

M000725-1

2(2)

2010-04-29

Certificates: 3-phase induction motors, series M2GP, M3JP, M3KP, M3GC, M3HP, M3PLP

Group & category, IEC marking class, protection	Motor type	Certification number	Year of CE-marking
Flameproof II 2 G Ex d I B / II C T1-T6 II 2 G Ex de II B / II C T1-T6 In addition: II 2 D Ex ID A21 / IP 65 or II 3 D Ex ID A22 / IP 55, IP65 (30 not for M3JPK/P160-180 Gen.H)	M3JPM3KP 80	LCIE 04 ATEX 6150	2004
	M3JPM3KP 90	LCIE 04 ATEX 6151	2004
	M3JPM3KP 100-112	LCIE 04 ATEX 6152	2004
	M3JPM3KP 132	LCIE 04 ATEX 6081	2004
	M3JPM3KP 160	LCIE 00 ATEX 6023	2000
	M3JPM3KP 180	LCIE 00 ATEX 6028	2000
	M3JPM3KP 180 Gen.H	LCIE 09 ATEX 3004X	2009
	M3JPM3KP 180 Gen.H	LCIE 09 ATEX 3005X	2009
	M3JPM3KP 200	LCIE 00 ATEX 6027	2000
	M3JPM3KP 225	LCIE 00 ATEX 6029	2000
	M3JPM3KP 250	LCIE 01 ATEX 6030	2001
	M3JPM3KP 280	LCIE 01 ATEX 6078	2001
	M3JPM3KP 315	LCIE 01 ATEX 6079	2001
	M3JPM3KP 355	LCIE 03 ATEX 6080	2003
	M3JPM3KP 400	LCIE 04 ATEX 6087	2004
Increased safety II 2 G Ex e II T2-T3 In addition for M3HP160 - 400: II 2 D Ex ID A21	M3HP 80-90	LCIE 06 ATEX 6047	2006
	M3HP 100-112	LCIE 06 ATEX 6048	2006
	M3HP 132	LCIE 06 ATEX 6049	2006
	M3HP 160	LCIE 01 ATEX 6015	2001
	M3HP 180	LCIE 01 ATEX 6021	2001
	M3HP 180 Gen.H	LCIE 09 ATEX 3022	2009
	M3HP 180 Gen.H	LCIE 09 ATEX 3023	2009
	M3HP 200	LCIE 01 ATEX 6022	2001
	M3HP 225	LCIE 01 ATEX 6023	2001
	M3HP 250	LCIE 01 ATEX 6024	2001
	M3HP 280	LCIE 02 ATEX 6071	2002
	M3HP 315	LCIE 02 ATEX 6072	2002
	M3HP 355	LCIE 03 ATEX 6022	2003
	M3HP 400	LCIE 04 ATEX 6013	2004
	Non-sparking II 3S Ex nA II T2-T3	M3GP 71-250	LCIE 06 ATEX 6160
M3GP 80 - 400		LCIE 06 ATEX 6088	2006
M3GP 160 - 180 Gen.H		LCIE 09 ATEX 1010 *	2009
Dust ignition II 2 D Ex ID A21 IP 65	M3GP 160 - 180 Gen.H	LCIE 09 ATEX 1010 *	2009
	M3GPM3PLP 450	LCIE 06 ATEX 6088	2006
Dust ignition II 3 D Ex ID A22	M3GP 160 - 180 Gen.H	LCIE 09 ATEX 1010 *	2009
	M3GPM3PLP 450	LCIE 06 ATEX 6088	2006
Dust ignition II 2 D Ex ID A21 IP 65 or II 3 D Ex ID A22 IP 55, IP65	M2GP 71-250	LCIE 05 ATEX 6160	2005
	M3GP 80-400	LCIE 06 ATEX 6089	2006

1) Notified Body (EXNB) LCIE (0081) - Av. Du Général Leclerc, 33, 92266 Fontenay-aux-Roses, France
2) *) Voluntary Type Examination Certificate for equipment category 3

3GZF500930-988

M000725-2

Flameproof motors Ex de in brief, basic design

Motor size		80	90	100	112	132	160	180	
Stator	Material	Cast iron, at least EN-GJL-200							
	Paint colour shade	Blue, Munsell 8B 4.5/3.25 (≈ NCS 4822-B05G)							
	Corrosion class	C3 medium according to ISO/EN 12944-5							
Bearing end shields	Material	Cast iron, at least EN-GJL-200							
	Paint colour shade	Blue, Munsell 8B 4.5/3.25 NCS 4822-B05G							
	Corrosion class	C3 medium according to ISO/EN 12944-5							
Bearings	D-end	2-pole	6204-2Z/C3	6205-2Z/C3	6206-2Z/C3	6206-2Z/C3	6208-2Z/C3	6309/C3	6310/C3
		4-12 -pole						6309/C3	6310/C3
	N-end	2-pole	6204-2Z/C3	6205-2Z/C3	6206-2Z/C3	6206-2Z/C3	6208-2Z/C3	6309/C3	6309/C3
		4-12 -pole						6309/C3	6309/C3
Axially-locked bearings	Inner bearing cover	As standard, locked at D-end							
Bearing seal		Gamma ring							
Lubrication		Permanent grease lubrication					Regreasable bearings		
SPM-nipples		-					As standard		
Rating plate	Material	Stainless steel							
Terminal box	Frame material	Cast iron, at least EN-GJL-200							
	Cover material	Cast iron, at least EN-GJL-200							
	Cover screws material	Acidproof steel A4-80					Steel 8.8, zinc electroplated and chromated		
Connections	Cable entries	1xM25x1.5		1xM32x1.5		2xM40x1.5			
	Terminals	6 terminals for connection with cable lugs (not included)							
Fan	Material	Polyamide. Reinforced with glass fibre.					Polypropylene. Reinforced with glass fibre.		
Fan cover	Material	Steel					Hot dip galvanized steel		
	Paint colour shade	Blue, Munsell 8B 4.5/3.25 NCS 4822-B05G							
	Corrosion class	C3 medium according to ISO/EN 12944-5							
Stator winding	Material	Copper							
	Insulation	Insulation class F							
	Winding protection	3 pcs thermistors as standard							
Rotor winding	Material	Pressure die-cast aluminum							
Balancing		Half key balancing							
Key way		Closed key-way							
Heating elements	On request	25 W							
Drain holes		-					Optional		
External earthing bolt		As standard							
Enclosure		IP 55							
Cooling method		IC 411							

Flameproof motors Ex de in brief, basic design

Motor size		200	225	250	280	315	355	400	
Stator	Material	Cast iron, at least EN-GJL-200							
	Paint colour shade	Blue, Munsell 8B 4.5/3.25 NCS 4822-B05G							
	Corrosion class	C3 medium according to ISO/EN 12944-5							
Bearing end shields	Material	Cast iron, at least EN-GJL-200							
	Paint colour shade	Blue, Munsell 8B 4.5/3.25 NCS 4822-B05G							
	Corrosion class	C3 medium according to ISO/EN 12944-5							
Bearings	D-end	2-pole	6312M/C3	6313M/C3	6315M/C3	6316/C3	6316/C3	6316M/C3	6317M/C3
		4-12 -pole	6312/C3	6313/C3	6315/C3	6316/C3	6319/C3	6322/C3	6324/C3
	N-end	2-pole	6310M/C3	6312M/C3	6313M/C3	6316/C3	6316/C3	6316M/C3	6317M/C3
		4-12 -pole	6310/C3	6312/C3	6313/C3	6316/C3	6316/C3	6316/C3	6319/C3
Axially-locked bearings	Inner bearing cover	As standard, locked at D-end							
Bearing seal		Gamma-ring				V-ring			
Lubrication		Regreasable bearings							
SPM-nipples		As standard							
Rating plate	Material	Stainless steel							
Terminal box	Frame material	Cast iron, at least EN-GJL-200							
	Cover material	Cast iron, at least EN-GJL-200							
	Cover screws material	Steel 8.8, zinc electroplated and chromated							
Connections	Cable entries	2xM50x1.5				2xM63x1.5 2x Ø60		2x Ø60/80	2x Ø80
	Terminals	6 terminals for connection with cable lugs (not included)							
Fan	Material	Polypropylene. Reinforced with glass fibre.						Polypropylene. Reinforced with glass fibre or aluminum.	
Fan cover	Material	Hot dip galvanized steel							
	Paint colour shade	Blue, Munsell 8B 4.5/3.25 (* NCS 4822-B05G)							
	Corrosion class	C3 medium according to ISO/EN 12944-5							
Stator winding	Material	Copper							
	Insulation	Insulation class F							
	Winding protection	3 pcs thermistors as standard							
Rotor winding	Material	Pressure die-cast aluminum							
Balancing method		Half key balancing							
Key way		Close				Open			
Heating elements	On request	25 W	60 W			120 W			
Drain holes		Optional							
External earthing bolt		As standard							
Enclosure		IP 55							
Cooling method		IC 411							

Increased safety motors, Ex e II T3 Totally enclosed squirrel cage three phase low voltage motors, Sizes 80 - 400, 0.55 to 390 kW



www.abb.com/motors&generators

- > Motors for explosive atmospheres
- >> Increased safety motors



Mechanical design

Drain holes

Increased safety Ex e motors in frame sizes 160-450 are fitted with drain holes and plugs as standard. Plugs are of plastic material and are delivered in open position.

Drain holes and plugs are available for frame sizes 80-132 as an option. Please see variant code section.

Type of protection	Frame material	Frame size	Drain holes
Increased safety	Cast iron	80-132	optional
		160-400	open

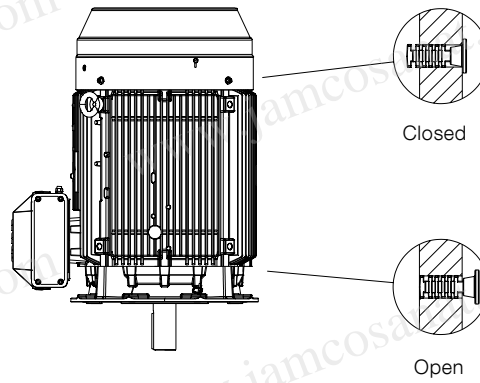
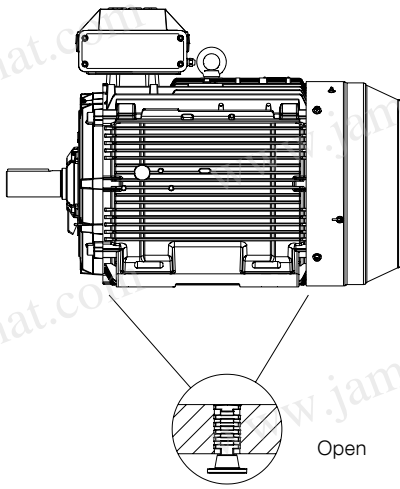

M000178

Terminal box standard delivery

Terminal boxes are mounted on top of the motor at D-end as standard. The terminal boxes of motor sizes 80-355 can be turned 4x90° and in motor sizes 400 2x180° after delivery. When ordering Ex e motors in sizes 280-400 with 4x90°, the position of the terminal box has to be defined in the order.

The degree of standard terminal box is IP55 and it complies with the requirements of this enclosure type and effectively prevents all ignition sources such as sparks, excessive overheating etc. The features of the terminal box are : no selfloosening terminals, compliance with creepage distances and clearances specified in standards.

If no ordering information on the cable is given, it is assumed to be p.v.c. -insulated non-armoured and termination parts are supplied according to the table on the following pages.

To enable the supply of suitable terminations for the motor, please state cable type, quantity, size and outer diameter when ordering.

All Ex e motors are delivered as standard with cable glands or cable sealing end units according to the below table. Different glands can be provided separately as an option. Please see Alternatives section for details.

Note: For 500 V motor information please contact ABB!

Standard delivery 400/690 V (if nothing else informed)

Motor size	Pole number	Terminal box type	Terminal box opening	45° adapter (variant code)	Threaded holes	Cable gland	Cable sealing end unit (variant code)	Cable outer diameter mm	Single core cross-section mm ² for rated power	Terminal bolt size 6 x
80-90	2-8	25	B	-	1xM25	1xM25	-	1xØ10-16	10	M5
100-132	2-8	25	B	-	2xM32	2xM32	-	2xØ16-21	10	M5
160-180	2-8	63	B	-	2xM40	2xM40	-	2xØ19-27	35	M6
200-250	2-8	160	B	-	2xM50	2xM50	-	2xØ34-45	70	M10
280	2-8	210	C	-	2xM63	2xM63	-	2xØ32-49	2x150	M12
315SM, ML	2-8	370	D	-	2xM63	2xM63	-	2xØ32-49	2x240	M12
315LKA, LKB	2-4	370	D	-	2xM63	2xM63	-	2xØ32-49	2x240	M12
315LKC	2-4	750	E	E-D (294)	-	-	medium (278)	2xØ48-60	4x240	M12
315 LKA, LKB, LKC	6-8	370	D	-	2xM63	2xM63	-	2xØ32-49	2x240	M12
355 SMA, SMB, SMC	2-4	750	E	E-D (294)	2xM63	2xM63	medium (278)	2xØ48-60	4x240	M12
355 SMC	6	750	E	E-D (294)	2xM63	2xM63	medium (278)	2xØ48-60	4x240	M12
355 SMC	8	370	D	-	2xM63	2xM63	-	2xØ32-49	2x240	M12
355 SMA, SMB	6-8	370	D	-	2xM63	2xM63	-	2xØ32-49	2x240	M12
355 ML, LK	2-4	750	E	E-D (294)	-	-	large (279)	2xØ60-80	4x240	M12
355 ML, LK	6-8	750	E	E-D (294)	-	-	medium (278)	2xØ48-60	4x240	M12
400 L, LK	2-6	750	E	E-D (294)	-	-	large (279)	2xØ60-80	4x240	M12
400 L, LK	8	750	E	E-D (294)	-	-	medium (278)	2xØ48-60	4x240	M12

Auxiliary cable entries

80-132	2-8				1xM20	1xM20		1xØ8-14		
160-400	2-8				2xM20	2xM20		1xØ8-14		

Earthing on motor

	Frame	Terminal box
80-132	M6	M6
160-180	M6	M6
200-250	M8	M8
280-315	M10	2xM10
355-400	M10	2xM10

Terminal box alternatives, cast iron frame

Optional adapters

There is a broad selection of cable termination accessories available to allow termination of one or several cables. The most common ones are explained below, for other options please contact ABB.

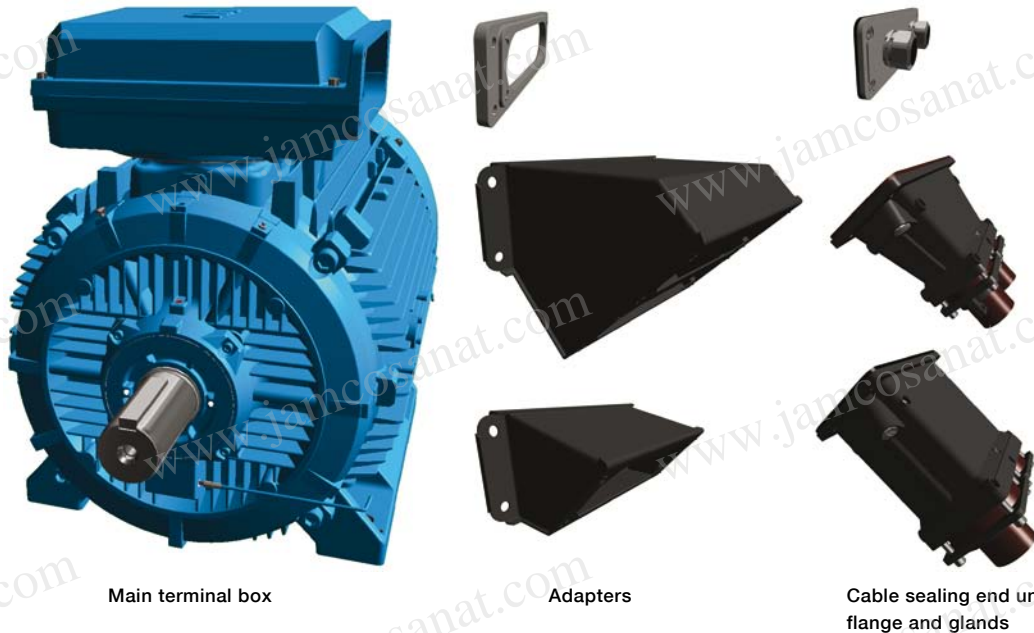

Main terminal box

Adapters

Cable sealing end units, flange and glands

M000443

How to order?

- Check first that the terminal box can allow mounting of the cable and cores (refer to motor type and terminal box type cross reference page 91).
- If very large cables are used might it be necessary to use a larger terminal box than standard. Select the right cable gland(s) or cable sealing end unit(s) depending on outer diameter of the cable(s).
- Select a appropriate adapter and gland(s) and gland plate or cable sealing end unit.
- Note that turning the terminal box to a non standard position might limit the use of some adapters.

Ordering example

Motor	145 kW, 4 pole, 400 V 50 Hz,
Cables	cables needed: 2 pieces, outer diameter 58 mm, single cross section 185mm, cables coming from below
Needed one terminal box for anticondensation heaters (220V) and another for temperature detectors, terminal box material cast iron.	
Motor	M3HP 315 MLA 4, B3
Adapter	D-D (variant code 293)
Cable sealing end unit	Variant code 278
Auxiliaries	Variant codes 451, 380, 567, 568

1. Main terminal box and maximum single core cross section

Larger than standard single core cross section is available as option according to the table below. Also one size larger terminal box can be selected. Please check also the capacity of the cable entry to make sure the cables fit.



Standard terminal box	Size of opening	Max single cross section per phase mm ²	Variant code 019 larger terminal box than standard	Size of opening with larger terminal box than standard Variant code 019	Max single cross section per phase mm ²
25	B	35	-	-	-
63	B	95	-	-	-
160	C	120	-	-	-
210	C	2 x 240	370	D	2 x 300
370	D	2 x 300	750	E	4 x 500
750	E	4 x 500	1200	E	4 x 500

The accessories for using the maximum single core cross sections are not included as standard. For this option please use variant code 300 (Increased single core cross section). Each terminal has got limited maximum cable entry size, please request if necessary.

2. Optional adapters

To allow easy termination of cables entering the terminal box from above or below is it recommended to use an angle adapter.

These can also be used to allow mounting of several cable sealing end units or gland plates on the terminal box for termination of more cables than one cable sealing end unit or gland plate can allow.

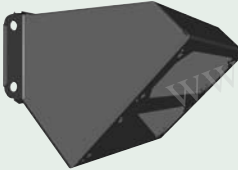
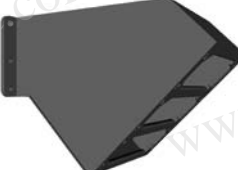
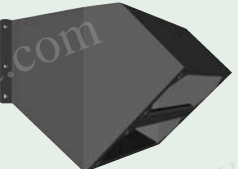
Adapter	Variant code	Opening towards terminal box	Glandplate or opening for cable sealing end unit	Material	Notes
	292 M000430	C	C	Steel	
	293 M000431	D	D	Steel	
	294 M000432	E	D	Steel	Included in std delivery with 750 type terminal box
	295 M000433	E	2 pcs E	Steel	Only possible on terminal box 1200
	296 M000434	E	3 pcs D	Steel	Only possible on terminal box 1200
	444 M000435	E	2 pcs D	Steel	Included in std delivery with 1200 type terminal box

Note: Black painted steel

3. Glandplate, maximum size of glands and material

Glandplates delivered blind or be drilled and tapped to accommodate glands to suit the cable diameter and amount of glands needed.

Standard gland plate material is siluminium, painted steel or stainless steel are available as options.

Size	Maximum size and number of glands, metric		
C	2xM90	3xM50	7xM32
D	4xM90	4xM63	7xM50
E	6xM90	7xM63	9xM50

Related variant codes:

- 729 Cable flanges without holes / Blank gland plates.
- 730 Prepared for NPT glands
- 732 Standard cable gland, Ex d IIB, armoured cable.
- 733 Standard cable gland, Ex d IIB, non-armoured cable.
- 743 Painted steel, blind
- 744 Stainless steel, blind
- 745 Painted steel with brass glands
- 746 Stainless steel with brass glands

4. Cable glands and cable sealing end units

Cable glands

Table below shows the selection of cable gland types and possible cable outer diameter of each size.

Outer diameter, mm			
	Variant code 745	Variant code 737	Variant code 704
	Painted steel flange equipped with brass cable glands	Standard cable gland Ex e with clamping device acc. to EN-Standards	EMC cable gland
Motor sizes 80-450:			
M20	8-14	8-14	8-14
M25	10-16	10-16	10-16
M32	14-21	14-21	14-21
M40	18-27	18-27	18-27
M50	26-35	26-35	26-35
M63	32-49	32-49	32-49
M75	46-60	NA	NA
M90	55-70	NA	NA



For armoured and NPT cable glands please contact ABB.

Cable sealing end unit

As an alternative to flanges and cable glands, cable sealing units can be used. These allow more space for spreading the cores for easy terminating on the terminals.

Cable sealing end units have rubber sealed entries for one or two main cables. In addition are there two M20 plugged holes for auxiliary cables.



					Accessories	
Variant code	Opening towards terminal box	Cable outer diameter mm	Cable entry auxiliary cable	Variant code 704; EMC cable gland	Variant code 231; Standard cable gland with clamping device	
 M000436 277	C	1 or 2 pcs (48-60 mm *)	2 pcs M20 plugged holes	Optional	Optional	
 M000437 278	D	1 or 2 pcs (48-60 mm *)	2 pcs M20 plugged holes	Optional	Optional	
 M000438 279	D	1 or 2 pcs (60-80 mm *)	2 pcs M20 plugged holes	Optional	Optional	

*) Depending on how the cable seal inside the cable sealing end unit is used also 40-52mm is available.

5. Auxillary terminal box

It's possible to equip the motors from frame size 160 upwards with one or several auxillary terminal boxes for connection of auxiliaries like heaters or temperature detectors.

The standard auxillary terminal box is made of aluminium and equipped with M20 glands for entry of the connection cables. As an option cast iron terminal box is available.

Connection terminals are spring loaded type for quick and easy connection. These are suitable for up to 2,5mm² wires. Auxillary terminal boxes are equipped with an earthing terminal.

As standard the first auxillary terminal box is located on RHS seen from D-end.

Small, aluminum auxiliary terminal box
(80 x 125 mm, for max 12 wires)
Earthing size M4



M000439

Large, aluminum auxiliary terminal box
(80 x 250 mm, for max 30 wires)
Earthing size M4



M000440

Cast iron auxiliary terminal box
(211 x 188 mm, for max 30 wires)
Earthing size M6



M000441

Standard cable entry size M20. Number of entries depends on the terminal box type and number of selected auxiliaries.

Related variant codes:

- 418 Separate terminal box for auxiliaries, standard material (all connections of temperature detectors and heaters will be put in same box)
- 380 Separate terminal box for temperature detectors, standard material
- 568 Separate terminal box for heating elements, standard material
- 569 Separater terminal box for brakes, standard material
- 567 Separate terminal box material: Cast iron

Dimension drawings

Increased safety motors, cast iron frame

Terminal boxes, standard design with 6 terminals

Motor sizes 80 - 132

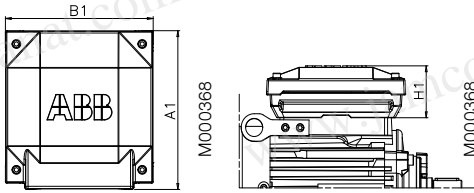

Motor sizes 160 - 180

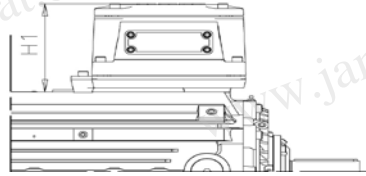

Motor sizes 200 - 250

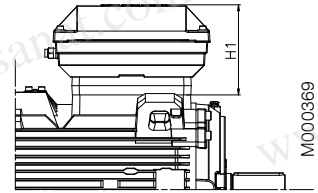

Motor sizes 280 - 315

Top- and side-mounted
Terminal boxes 210,370

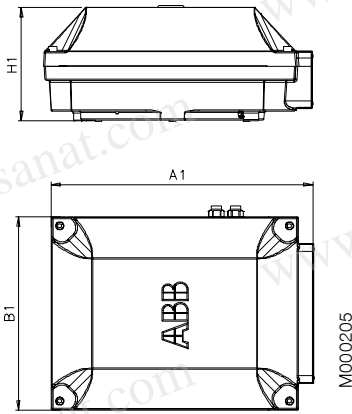

Motor sizes 355 - 400

Top-mounted
Terminal box 750 + adapter

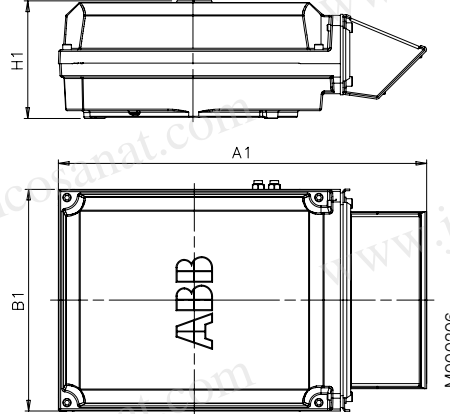

Motor sizes 355 - 400

Side-mounted
Terminal box 750

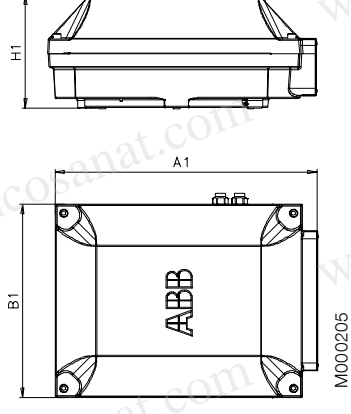

Terminal box according to EN:

Motor size	Terminal box	A1	B1	H1
80-132	25	202	188	66
160-180	63	234	234	68
200-250	160	352	319	147
280-400	210	416	306	177
	370	451	347	200
	750 top-mounted	686	413	219
	750 side-mounted	525	413	219

Terminal box according to VIK:

Motor size	Terminal box	A1	B1	H1
80-132	25	202	188	66
160-180	63	244	240	128
200-250	160	352	319	147
280-400	210	416	306	177
	370	451	347	200
	750 top-mounted	686	413	219
	750 side-mounted	525	413	219

For motor dimensions please see dimension drawings on earlier pages.

Permissible loadings on the shaft end

The following tables give the permissible radial and axial forces in Newton, assuming only radial or axial force is applied. Permissible loads of simultaneous radial and axial forces will be supplied on request.

The bearing life, L_{10} , is calculated according to ISO 281:1990/ Amd 2:2000 standard theory, which also takes the purity of the grease into consideration. An adequate lubrication is a necessary prerequisite for the table below.

The values are based on normal conditions at 50 Hz. At 60 Hz the values must be reduced by 10 %. For two-speed motors, the values must be based on the higher speed.

Motors are foot-mounted IM B3 version with force directed sideways. In some cases the strength of the shaft affects the permissible forces.

If the bearing at the D-end is replaced with a roller bearing (NU- or NJ-), higher radial forces can be handled. Roller bearings are suitable for belt drive applications.

If the radial force is applied between points X_0 and X_{max} , the permissible force F_R can be calculated from the following formula:

$$F_R = F_{X_0} - \frac{X}{E} (F_{X_0} - F_{X_{max}})$$

E = length of shaft extension in basic version

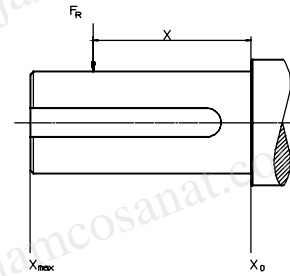

M000145

Cast iron motors, sizes 80 to 132

Permissible radial forces according to L_{10} principle

Increased safety

Motor size	Poles	Length of shaft extension E (mm)	Ball bearings 40,000 hours	
			F_{X_0} (N)	$F_{X_{max}}$ (N)
80	2	40	619	524
	4	40	780	663
	6	40	893	759
	8	40	983	834
90	2	50	561	473
	4	50	803	677
	6	50	919	775
	8	50	1011	853
100	2	60	553	457
	4	60	1050	868
	6	60	1267	1047
	8	60	1395	1153
112	2	60	553	457
	4	60	1050	868
	6	60	1267	1047
	8	60	1394	1152
132	2	80	1354	1112
	4	80	1772	1454
	6	80	2028	1665
	8	80	2234	1833

Cast iron motors, sizes 160 to 400

Permissible radial forces according to L₁₀ principle

Increased safety motors

Motor size	Poles	Length of shaft extension E (mm)	Ball bearings				Roller bearings			
			20,000 hours		40,000 hours		20,000 hours		40,000 hours	
			FX ₀ (N)	FX _{max} (N)	FX ₀ (N)	FX _{max} (N)	FX ₀ (N)	FX _{max} (N)	FX ₀ (N)	FX _{max} (N)
160	2	110	3180	2200	2500	2100	7850	2200	6400	2200
	4	110	4000	2200	3150	2200	8800	2200	7850	2200
	6	110	4600	2200	3650	2200	8800	2200	8800	2200
	8	110	4950	2100	3900	2100	8800	2100	8750	2100
180	2	110	3650	3050	2900	2400	8400	3500	6950	3500
	4	110	4600	3850	3650	3050	9700	3500	8500	3500
	6	110	5250	4400	4150	3500	9700	3500	9700	3500
	8	110	5650	3050	4500	3050	9900	3050	9900	3050
200 ML	2	110	4800	3950	3800	3150	11700	4550	9500	4550
	4	110	6050	4550	4800	3950	14400	4550	11700	4550
	6	110	6950	4550	5500	4550	16250	4550	13200	4550
	8	110	7650	4550	6050	4550	17700	4550	14400	4550
225 SM	2	110	5450	4500	4350	3550	14300	4550	11650	4550
	4	140	6900	4650	5450	4400	17650	4650	14300	4550
	6	140	7900	4650	6250	4650	19900	4650	16200	4650
	8	140	8700	4650	6900	4650	21700	4650	17650	4650
250 SM	2	140	6750	4100	5350	4100	18950	4100	15400	4100
	4	140	8550	5800	6750	5450	23350	5800	18950	5800
	6	140	9800	5800	7750	5800	26400	5800	21400	5800
	8	140	10750	5800	8550	5800	28750	5800	23350	5800
280 SM	2	140	7300	6000	5800	4900	20400	6000	16500	6000
	4	140	9200	7800	7300	6200	25100	9200	20300	9200
	6	140	10600	8900	8400	7000	28300	9200	23000	9200
	8	140	11700	9200	9200	7800	30900	9200	25100	9200
315 SM	2	140	7300	6000	5800	4950	20300	6000	16500	6000
	4	170	11400	9400	9000	7450	32500	9600	26600	9600
	6	170	13000	9600	10300	8500	37000	9600	30000	9600
	8	170	14400	9600	11400	9400	40300	9600	32700	9600
315 ML	2	140	7400	6400	5850	5050	20600	5850	16700	5850
	4	170	11500	9700	9100	7650	32700	13600	26500	13600
	6	170	13200	11100	10400	8800	36900	13600	29900	13600
	8	170	14500	12200	11500	9700	40200	13600	32600	13600
315 LK	2	140	7400	6550	5800	5150	20800	5550	16800	5550
	4	170	11500	10000	9100	7850	33100	13350	26800	13350
	6	170	13200	11400	10450	9050	37300	13350	30300	13350
	8	170	14600	12600	11550	10000	40800	13350	33100	13350
355 SM	2	140	7350	6450	5750	5050	20600	7200	16700	7200
	4	210	15200	12600	12000	9950	45500	14000	36900	14000
	6	210	17500	14000	13800	11400	51400	14000	41700	14000
	8	210	19300	14000	15250	12600	56000	14000	45500	14000
355 ML	2	140	7350	6550	5750	5100	20800	6750	16800	6750
	4	210	15300	12900	12000	10100	45900	13600	37200	13600
	6	210	17600	13600	13900	11600	51500	13600	42100	13600
	8	210	19400	13600	15300	12900	56000	13600	45900	13600
355 LK	2	140	7350	6650	5650	5150	21000	6750	17000	6750
	4	210	15200	13000	11850	10200	46000	13000	37300	13000
	6	210	17500	13000	13700	11900	52000	13000	42000	13000
	8	210	19400	13000	15200	13000	56500	13000	46000	13000
400 LK	2	170	7650	6850	4400	3900	23900	9050	19350	9050
	4	210	15600	11500	12150	10550	52500	11500	43300	11500
	6	210	17800	11500	13850	11500	60000	11500	48800	11500
	8	210	19700	11500	15350	11500	65700	11500	53200	11500
400 L	2	170	7650	6850	4400	3900	23900	9050	19350	9050
	4	210	15600	13550	12150	10550	52500	16000	43300	16000
	6	210	17800	15450	13850	12000	60000	16000	48800	16000
	8	210	19700	16000	15350	13350	65700	16000	53200	16000

Permissible axial forces according to L₁₀ principle



Cast iron motors

Mounting arrangement IM B3

Motor size	20,000 hours								40,000 hours							
	2-pole		4-pole		6-pole		8-pole		2-pole		4-pole		6-pole		8-pole	
	F _{AD} N	F _{AZ} N	F _{AD} N	F _{AZ} N	F _{AD} N	F _{AZ} N	F _{AD} N	F _{AZ} N	F _{AD} N	F _{AZ} N	F _{AD} N	F _{AZ} N	F _{AD} N	F _{AZ} N	F _{AD} N	F _{AZ} N
80	820	460	1010	650	1180	820))))))))))
90	900	380	1110	590	1260	740))))))))))
100	1330	440	1620	730	1820	940))))))))))
112	1330	440	1610	720	1820	930))))))))))
132 S ₋	1880	850	2330	1290	2650	1610))))))))))
160	2820	1910	3560	2650	4150	3240	4630	3720	2220	1310	2780	1870	3230	2320	3590	2680
180	3190	2280	4080	3170	4720	3810	5260	4350	2500	1590	3160	2250	3640	2740	4060	3150
200	4230	2960	5380	4120	6270	5000	6960	5700	3320	2060	4184	2920	4850	3590	5380	4120
225	4740	3270	6070	4600	7020	5550	7830	6360	3720	2250	4720	3250	5430	3970	6050	4590
250	6470	3370	8100	5000	9250	6150	10220	7130	5220	2130	6440	3340	7300	4210	8040	4950
280 SM ₋	4200	6250	6000	8000	5250	11250	8300	10300	2900	4900	4250	6250	5150	7150	5950	7950
315 SM ₋	4180	6200	7400	9400	8900	10900	10000	12000	2850	4850	5250	7250	6350	8350	7200	9000
315 ML ₋	4050	6050	7250	9250	8650	10650	9500	11900	2750	4750	5100	7100	6100	8100	6900	8800
315 LK ₋	4000	5950	7100	9150	8500	10500	9750	11750	2650	4650	5000	7000	5950	7950	6900	8900
355 SM ₋	3050	6850	8600	12400	10550	14350	12200	16000	1750	5550	5900	9700	7300	11100	8550	12350
355 ML ₋	2900	6700	8350	12150	10100	13900	12000	15800	1600	5400	5650	9450	6900	10700	7300	11000
355 LK ₋	2850	6650	8200	12000	9900	13700	11450	15250	1550	5350	5450	9250	6700	10500	7800	11600
400 LK ₋	2150	7150	7100	13100	8850	14850	10450	16450)	5800	4300	10300	5500	11500	6750	12750
400 L ₋	2150	7150	7100	13100	8850	14850	10450	16450)	5800	4300	10300	5500	11500	6750	12750

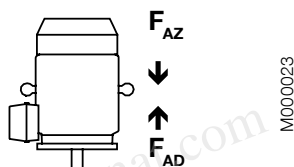

Mounting arrangement IM V1

Motor size	20,000 hours								40,000 hours							
	2-pole		4-pole		6-pole		8-pole		2-pole		4-pole		6-pole		8-pole	
	F _{AD} N	F _{AZ} N	F _{AD} N	F _{AZ} N	F _{AD} N	F _{AZ} N	F _{AD} N	F _{AZ} N	F _{AD} N	F _{AZ} N	F _{AD} N	F _{AZ} N	F _{AD} N	F _{AZ} N	F _{AD} N	F _{AZ} N
80	850	440	1060	650	1220	800))))))))))
90	940	350	1150	550	1320	690))))))))))
100	1400	390	1710	650	1940	860))))))))))
112	1410	380	1730	640	1950	850))))))))))
132 S ₋	2010	730	2520	1150	2890	1440))))))))))
160	3070	1660	4060	2320	4530	2890	4950	3350	2470	1060	3280	1530	3600	1970	3910	2310
180	3580	1980	4650	2680	5430	3340	5970	3890	2880	1280	3730	1760	4360	2260	4760	2680
200	4790	2480	6240	3550	7070	4300	7850	5020	3870	1560	5030	2340	5650	2890	6260	3430
225	5540	2670	7000	3860	8130	4700	8860	5480	4510	1650	5640	2500	6540	3100	7080	3700
250	7390	2640	9200	4080	10670	5000	11660	5970	6135	1380	7530	2410	8710	3040	9470	3780
280 SM ₋	5550	5150	7600	6550	9150	7500	10200	9000	4200	3800	5800	4750	7000	5350	7850	6700
315 SM ₋	5950	4600	9750	7500	11600	8300	13350	9900	4600	3300	7550	5300	9050	5750	10450	7000
315 ML ₋	6650	4300	10500	7050	12900	7800	13400	8300	5300	2900	8300	4900	10350	5250	11600	5400
315 LK ₋	7100	3350	11100	5850	13700	6100	14900	8300	5750	2450	8900	3700	11100	3550	12100	5450
355 SM ₋	6350	4250	13250	8600	15650	9580	17350	12500	4950	2900	10450	5850	12350	6270	13600	8900
355 ML ₋	7100	3700	14600	7950	18050	8600	21100	11650	5750	2350	11850	5150	14700	5300	17000	7600
355 LK ₋	7500	3150	15650	6600	19100	7050	21200	8700	6150	1800	12850	3800	15800	3750	17500	5000
400 LK ₋	8650	2150	16050	6400	18450	6750	20100	8350	7220)	13150	3400	15100	3400	16450	4700
400 L ₋	8650	2150	16050	6400	18450	6750	20100	8350	7220)	13150	3400	15100	3400	16450	4700

) On request

Rating plates

The rating plates are in table form giving values for speed, current and power factor for one voltage: 400V as standard. Other voltage and frequency combinations are possible and can be ordered with variant codes 002 or 209. Please see Variant code section.

The following information will be shown on the motor rating plate according to IEC 60034-30:2008:

- Lowest nominal efficiency at 100%, 75% and 50% rated load
- Efficiency level
- Year of manufacture
- Type of protection
- Apparatus group
- Temperature class
- Identification number of the certification body
- Certificate number: ATEX
- I_A/I_N
- t_E

M3HP 80-400

ABB Oy, Motors Vaasa, Finland							
CE 0081 IE2							
3 ~ Motor M3HP 225SMC 4 IMB3/IM1001							
Ex e II T3							
414141-47				2010 No. 3GF1000007			
S1				Ins.cl. F		IP 55	
V	Hz	KW	r/min	A	cos φ	I _A /I _N	t _E /s
400 D	50	43	1479	76	0.90	7.7	5
IE2-93.4%(100%)-93.6%(75%)-92.9%(50%)							
Prod.code 3GHP222230-ADG							
LCIE 01 ATEX 6023				Nmax		r/min	
6313/C3				6312/C3		390 kg	
Ex II 2G ABB IEC 60034-1							

M000738

Ordering information

Sample order

When placing an order, please state the following minimum data in the order, as in example.

The product code of the motor is composed in accordance with the following example.

Motor type	M3HP 160 MLB
Pole number	2
Mounting arrangement (IM code)	IM B3 (IM 1001)
Rated output	8 kW
Product code	3GHP161420-ADE
Variant codes if needed	

Motor size

A	B	C	D.E.F.	G														
M3HP 160 MLB 3GHP 161420 - A D H 002 etc.																		
<table border="1" style="width: 100%; border-collapse: collapse;"> <tr> <td style="width: 12.5%; text-align: center;">1</td> <td style="width: 12.5%; text-align: center;">2</td> <td style="width: 12.5%; text-align: center;">3</td> <td style="width: 12.5%; text-align: center;">4</td> <td style="width: 12.5%; text-align: center;">5</td> <td style="width: 12.5%; text-align: center;">6</td> <td style="width: 12.5%; text-align: center;">7</td> <td style="width: 12.5%; text-align: center;">8</td> <td style="width: 12.5%; text-align: center;">9</td> <td style="width: 12.5%; text-align: center;">10</td> <td style="width: 12.5%; text-align: center;">11</td> <td style="width: 12.5%; text-align: center;">12</td> <td style="width: 12.5%; text-align: center;">13</td> <td style="width: 12.5%; text-align: center;">14</td> </tr> </table>					1	2	3	4	5	6	7	8	9	10	11	12	13	14
1	2	3	4	5	6	7	8	9	10	11	12	13	14					
A Motor type		C Product code	E Voltage and frequency code	G Variant codes														
B Motor size		D Mounting arrangement code	F Generation code															

Explanation of the product code:

Positions 1 to 4

3GHP = Totally enclosed fan cooled squirrel cage motor with cast iron frame, increased safety

Positions 5 and 6

IEC-frame

08 = 80	20 = 200
09 = 90	22 = 225
10 = 100	25 = 250
11 = 112	28 = 280
13 = 132	31 = 315
16 = 160	35 = 355
18 = 180	40 = 400

Position 7

Speed (Pole pairs)

1 = 2 poles
2 = 4 poles
3 = 6 poles
4 = 8 poles

Position 8 to 10

Serial number

Position 11

- (dash)

Position 12

Mounting arrangement

A = Foot-mounted, top-mounted terminal box
R = Foot-mounted, terminal box RHS seen from D-end
L = Foot-mounted, terminal box LHS seen from D-end
B = Flange-mounted, large flange
C = Flange-mounted, small flange (sizes 90 to 132)
H = Foot- and flange-mounted, terminal box top-mounted
J = Foot- and flange-mounted, small flange with tapped holes
S = Foot- and flange-mounted, terminal box RHS seen from D-end
T = Foot- and flange-mounted, terminal box LHS seen from D-end
V = Flange-mounted, special flange
F = Foot- and flange-mounted. Special flange

Position 13

Voltage and frequency

Single-speed motors

B 380 VΔ 50 Hz
D 400 VΔ, 415 VΔ, 690 VY 50 Hz
E 500 VΔ 50 Hz
F 500 VY 50 Hz
S 230 VΔ, 400 VY, 415 VY 50 Hz
T 660 VΔ 50 Hz
U 690 VΔ 50 Hz
X Other rated voltage, connection or frequency, 690 V maximum

Position 14

Generation code

G, H...

The product code must be, if needed, followed by variant codes.

Increased safety cast iron motors Ex e II T3

Technical data for totally enclosed squirrel cage three phase motors, acc. to EN

IE2



IP 55, IC 411; Insulation class F, temperature rise class B
IE2 efficiency class according to IEC 60034-30; 2008

			Efficiency IEC 60034-2-1; 2007			Current Torque					Time tE 50Hz	Moment of inertia J = 1/4 GD ² kgm ²	Sound pressure level L _{PA} dB				
Output kW	Motor type	Product code	Speed r/min	Full load 100%	3/4 load 75%	1/2 load 50%	Power factor cos φ	I _N A	I _s I _N	T _N Nm				T _I T _N	T _b T _N		
3000 r/min = 2-poles			400 V 50 Hz			GENELEC-design											
0.75	M3HP 80 MA	3GHP 081 310-●● ³⁾															
1.1	M3HP 80 MB	3GHP 081 320-●● ³⁾															
1.5	M3HP 90 SLA	3GHP 091 010-●● ³⁾															
2.2	M3HP 90 SLC	3GHP 091 030-●● ³⁾															
3	M3HP 100 LA	3GHP 101 510-●● ³⁾															
4	M3HP 112 MB	3GHP 111 320-●● ³⁾															
5.5	M3HP 132 SMB	3GHP 131 220-●● ³⁾															
7.5	M3HP 132 SMD	3GHP 131 240-●● ³⁾															
8	M3HP 160 MLB	3GHP 161 420-●●H	2939	91.0	90.7	88.8	0.91	14.0	7.2	25.9	2.8	3.5	15	0.052	216	69	
11	M3HP 160 MLC	3GHP 161 430-●●H	2932	90.3	90.4	89.3	0.92	19.5	6.9	35.8	2.6	3.4	9	0.062	227	69	
12.5	M3HP 160 MLD	3GHP 161 440-●●H	2944	92.5	92.6	92.2	0.91	21.0	7.6	40.5	2.8	3.4	8	0.07	233	69	
15	M3HP 180 MLB	3GHP 181 420-●●H	2947	91.0	91.1	90.1	0.91	26.0	7.1	48.6	2.2	3.0	15	0.13	292	69	
18	M3HP 180 MLC	3GHP 181 430-●●H	2960	93.3	93.6	93.0	0.91	31.0	7.6	58.0	2.4	3.2	11	0.13	292	69	
22	M3HP 200 MLC	3GHP 201 430-●●G	2956	91.9	91.7	90.2	0.90	38.5	6.9	71.0	2.6	3.5	10	0.21	305	72	
25	M3HP 200 MLE	3GHP 201 450-●●G	2957	93.8	93.9	93.0	0.90	44.0	7.0	80.7	2.9	3.8	9	0.22	310	72	
30	M3HP 225 SMB	3GHP 221 220-●●G	2963	92.3	92.0	90.5	0.91	51.0	7.4	96.6	2.1	3.0	10	0.31	365	74	
36	M3HP 225 SMD	3GHP 221 240-●●G	2965	93.3	93.2	92.1	0.92	60.0	8.0	115	2.3	3.2	7	0.36	395	74	
40	M3HP 250 SMB	3GHP 251 220-●●G	2973	93.2	93.0	91.6	0.91	67.0	7.8	128	2.2	3.0	8	0.66	475	74	
47	M3HP 250 SMC	3GHP 251 230-●●G	2972	93.7	93.6	92.6	0.91	80.0	7.8	151	2.3	3.0	6	0.69	495	74	
60	¹⁾ M3HP 280 SMA	3GHP 281 210-●●G	2975	93.9	93.6	92.4	0.91	100	7.3	192	1.2	2.9	10	0.8	625	77	
75	¹⁾ M3HP 280 SMB	3GHP 281 220-●●G	2975	94.2	94.0	93.0	0.91	125	7.6	240	1.2	2.9	8	0.9	665	77	
77	¹⁾ M3HP 315 SMA	3GHP 311 210-●●G	2984	94.1	93.5	91.7	0.90	132	7.3	246	0.9	2.9	13	1.2	880	78	
80	¹⁾ M3HP 280 SMC	3GHP 281 230-●●G	2975	94.3	94.2	93.2	0.92	132	7.4	256	1.2	2.8	7	1.15	725	77	
90	¹⁾ M3HP 315 SMB	3GHP 311 220-●●G	2983	94.6	94.2	92.7	0.90	152	7.2	288	0.9	2.8	10	1.4	940	78	
120	¹⁾ M3HP 315 SMC	3GHP 311 230-●●G	2982	95.1	94.9	93.7	0.91	201	7.4	384	1.0	2.9	6	1.7	1025	78	
135	¹⁾ M3HP 315 MLA	3GHP 311 410-●●G	2983	95.3	95.1	94.1	0.92	222	8.0	432	1.2	3.0	6	2.1	1190	78	
175	¹⁾ M3HP 355 SMA	3GHP 351 210-●●G	2987	95.9	95.5	94.4	0.91	290	7.4	559	0.8	3.2	10	3.0	1600	83	
200	¹⁾ M3HP 355 SMB	3GHP 351 220-●●G	2986	96.1	95.8	94.8	0.91	333	7.3	639	0.8	3.2	7	3.4	1680	83	
220	¹⁾ M3HP 355 MLA	3GHP 351 410-●●G	2983	96.2	96.0	94.9	0.91	363	7.1	704	0.9	3.0	8	4.1	2000	83	
300	¹⁾ M3HP 355 LKA	3GHP 351 810-●●G	2986	96.7	96.6	96.0	0.92	488	7.4	959	0.9	3.2	6	4.8	2320	83	
355	²⁾ M3HP 400 LB	3GHP 401 520-●●G	2989	97.1	96.9	96.2	0.91	580	7.6	1134	0.7	3.4	7	8.2	3050	82	
355	²⁾ M3HP 400 LKB	3GHP 401 820-●●G	2989	97.1	96.9	96.2	0.91	580	7.6	1134	0.7	3.4	7	8.2	3050	82	
400	²⁾ M3HP 400 LC	3GHP 401 530-●●G	2988	97.1	97.0	96.4	0.92	645	7.5	1278	0.8	3.4	6	9.3	3300	82	
400	²⁾ M3HP 400 LKC	3GHP 401 830-●●G	2988	97.1	97.0	96.4	0.92	645	7.5	1278	0.8	3.4	6	9.3	3300	82	

¹⁾ 3dB(A) sound pressure level reduction with unidirectional fan construction. Direction of rotation must be stated when ordering, see variant codes 044 and 045

²⁾ Unidirectional fan construction as standard. Direction of rotation must be stated when ordering, see variant codes 044 and 045

³⁾ Missing data on request

The two bullets in the product code indicate choice of mounting arrangements, voltage and frequency code (see ordering information page).

I_s / I_N = Starting current
T_I / T_N = Locked rotor torque
T_b / T_N = Pull-out torque

Efficiency values are given according to IEC 60034-2-1; 2007. Please note that the values are not comparable without knowing the testing method. ABB has calculated the efficiency values according to indirect method, stray load losses (additional losses) determined from measuring.

Increased safety cast iron motors Ex e II T3

Technical data for totally enclosed squirrel cage three phase motors, acc. to EN

IE2



IP 55, IC 411; Insulation class F, temperature rise class B
IE2 efficiency class according to IEC 60034-30; 2008

Output kW	Motor type	Product code	Speed r/min	Efficiency IEC 60034-2-1; 2007			Power factor cos φ	Current					Time tE 50Hz	Moment of inertia J = 1/4 GD ² kgm ²	Weight kg	Sound pressure level L _{PA} dB
				Full load 100%	3/4 load 75%	1/2 load 50%		I _N	I _s I _N	T _N	T _l T _N	T _b T _N				
1500 r/min = 4-poles			400 V 50 Hz			CENELEC-design										
0.55	M3HP 80 MA	3GHP 082 310-••	1459	90.0	90.8	90.4	0.85	21.0	6.7	71.9	2.6	3.1	12	0.096	226	62
0.75	M3HP 80 MB	3GHP 082 320-••	1469	91.7	92.1	91.3	0.84	29.0	8.0	97.5	3.1	3.6	9	0.13	249	68
1.1	M3HP 90 SLA	3GHP 092 010-••	1469	91.3	91.9	91.3	0.85	33.0	6.2	110	2.3	2.9	7	0.21	279	66
1.5	M3HP 90 SLC	3GHP 092 030-••	1474	91.9	92.2	91.5	0.85	38.0	7.6	129	2.7	3.1	11	0.248	298	66
2.2	M3HP 100 LA	3GHP 102 510-••	1479	93.0	93.2	92.7	0.88	47.0	7.9	167	1.9	3.1	13	0.3	280	73
3	M3HP 100 LB	3GHP 102 520-••	1477	93.2	93.7	93.4	0.89	54.0	7.4	193	1.9	3.0	9	0.35	305	73
4	M3HP 112 MC	3GHP 112 330-••	1479	92.8	93.0	92.6	0.89	67.0	7.7	245	1.7	3.1	9	0.45	365	74
5.5	M3HP 132 SMB	3GHP 132 220-••	1479	93.4	93.6	92.9	0.90	76.0	7.7	277	1.8	3.1	5	0.53	390	74
7.5	M3HP 132 SMD	3GHP 132 240-••	1482	94.3	94.6	94.0	0.88	88.0	7.1	322	1.5	3.1	8	0.77	425	73
11	M3HP 160 MLC	3GHP 162 430-••H	1483	94.8	95.0	94.6	0.89	105	7.3	386	1.7	3.2	8	0.98	470	73
15	M3HP 160 MLE	3GHP 162 450-••H	1485	94.5	94.7	94.3	0.88	113	7.4	417	1.5	3.0	8	1.25	625	68
17	M3HP 180 MLB	3GHP 182 420-••H	1484	94.6	94.8	94.4	0.89	130	7.2	482	1.5	3.0	6	1.5	665	68
20	M3HP 180 MLC	3GHP 182 430-••H	1483	94.8	95.0	95.0	0.90	139	7.0	528	1.5	2.8	6	1.85	725	68
26	M3HP 200 MLA	3GHP 202 410-••G	1488	95.0	95.1	94.7	0.88	165	6.9	609	1.1	2.5	8	2.3	900	73
30	M3HP 200 MLB	3GHP 202 420-••G	1488	95.1	95.3	95.0	0.88	188	6.8	705	1.1	2.6	8	2.6	960	73
38	M3HP 225 SMB	3GHP 222 220-••G	1486	95.2	95.4	95.2	0.89	217	6.8	822	1.1	2.6	5	2.9	1000	73
43	M3HP 225 SMC	3GHP 222 230-••G	1487	95.6	95.8	95.5	0.89	245	6.9	931	1.1	2.6	5	3.5	1160	73
50	M3HP 250 SMA	3GHP 252 210-••G	1492	96.3	96.3	95.7	0.87	330	7.1	1216	1.0	2.9	9	5.9	1610	75
60	M3HP 250 SMB	3GHP 252 220-••G	1492	96.4	96.4	95.7	0.87	393	7.3	1472	1.1	3.1	6	6.9	1780	78
65	M3HP 280 SMA	3GHP 282 210-••G	1491	96.6	96.7	96.2	0.88	475	7.0	1793	1.1	3.0	5	8.4	2140	78
75	M3HP 280 SMB	3GHP 282 220-••G	1490	96.5	96.6	96.2	0.88	525	6.9	1986	1.1	2.9	7	10	2500	78
82	M3HP 280 SMC	3GHP 282 230-••G	1491	96.9	96.9	96.5	0.89	590	6.4	2241	1.2	2.5	6	15	3200	78
95	M3HP 315 SMA	3GHP 312 210-••G	1491	96.9	96.9	96.5	0.89	590	6.4	2241	1.2	2.5	6	15	3200	78
110	M3HP 315 SMB	3GHP 312 220-••G	1493	97.1	97.1	96.6	0.88	660	7.4	2494	1.0	2.7	6	17	3400	78
128	M3HP 315 SMC	3GHP 312 230-••G	1493	97.1	97.1	96.6	0.88	660	7.4	2494	1.0	2.7	6	17	3400	78
145	M3HP 315 MLA	3GHP 312 410-••G														
190	M3HP 355 SMA	3GHP 352 210-••G														
230	M3HP 355 SMB	3GHP 352 220-••G														
280	M3HP 355 MLA	3GHP 352 410-••G														
310	M3HP 355 LKA	3GHP 352 810-••G														
350	M3HP 400 LA	3GHP 402 510-••G														
350	M3HP 400 LKA	3GHP 402 810-••G														
390	M3HP 400 LC	3GHP 402 530-••G														
390	M3HP 400 LKC	3GHP 402 830-••G														

¹⁾ Missing data on request

The two bullets in the product code indicate choice of mounting arrangements, voltage and frequency code (see ordering information page).

I_s / I_N = Starting current
T_l / T_N = Locked rotor torque
T_b / T_N = Pull-out torque

Efficiency values are given according to IEC 60034-2-1; 2007. Please note that the values are not comparable without knowing the testing method. ABB has calculated the efficiency values according to indirect method, stray load losses (additional losses) determined from measuring.

Increased safety cast iron motors Ex e II T3

Technical data for totally enclosed squirrel cage three phase motors, acc. to EN

IE2



IP 55, IC 411; Insulation class F, temperature rise class B
IE2 efficiency class according to IEC 60034-30; 2008

Output kW	Motor type	Product code	Speed r/min	Efficiency IEC 60034-2-1; 2007			Power factor cos φ	Current					Time tE 50Hz	Moment of inertia J = 1/4 GD ² kgm ²	Weight kg	Sound pressure level L _{PA} dB		
				Full load 100%	3/4 load 75%	1/2 load 50%		I _N	I _s I _N	T _N	T _l T _N	T _b T _N						
1000 r/min = 6-poles			400 V 50 Hz			CENELEC-design												
0.37	M3HP	80 MA	3GHP	083 310-●●	2)													
0.55	M3HP	80 MB	3GHP	083 320-●●	2)													
0.75	M3HP	90 SLA	3GHP	093 010-●●	2)													
1.1	M3HP	90 SLC	3GHP	093 030-●●	2)													
1.5	M3HP	100 LA	3GHP	103 510-●●	2)													
2.2	M3HP	112 MB	3GHP	113 320-●●	2)													
3	M3HP	132 SMB	3GHP	133 220-●●	2)													
4	M3HP	132 SMC	3GHP	133 230-●●	2)													
5.5	M3HP	132 SMD	3GHP	133 240-●●	2)													
6.6	M3HP	160 MLA	3GHP	163 410-●●H	973	87.4	87.8	86.8	0.80	13.8	7.3	64.7	2.1	3.4	14	0.088	220	57
7.5	M3HP	160 MLB	3GHP	163 420-●●H	971	88.2	88.6	87.7	0.78	16.0	7.5	73.7	2.4	3.6	18	0.126	247	65
11	¹⁾ M3HP	160 MLC	3GHP	163 430-●●H	971	88.4	88.9	88.1	0.77	23.0	7.3	108	2.6	3.8	7	0.126	247	65
14	¹⁾ M3HP	180 MLB	3GHP	183 420-●●H	975	88.1	88.4	87.4	0.80	28.5	7.6	137	1.8	3.0	16	0.25	298	67
16.5	M3HP	200 MLB	3GHP	203 420-●●G	984	91.8	92.0	91.1	0.85	31.0	7.0	160	3.2	3.3	23	0.47	290	65
20	M3HP	200 MLC	3GHP	203 430-●●G	983	92.4	92.9	92.3	0.85	38.0	7.1	194	3.0	2.7	17	0.52	305	65
30	M3HP	225 SMC	3GHP	223 230-●●G	985	92.9	93.1	92.7	0.84	56.0	7.0	290	2.9	3.0	7	0.78	380	64
37	M3HP	250 SMB	3GHP	253 220-●●G	988	93.0	93.4	93.0	0.87	66.0	7.2	357	2.6	2.8	10	1.6	465	65
45	M3HP	280 SMA	3GHP	283 210-●●G	986	93.1	93.5	93.3	0.88	79.0	6.7	435	1.5	2.8	13	1.85	605	66
50	M3HP	280 SMB	3GHP	283 220-●●G	987	93.6	94.0	93.8	0.88	87.0	7.0	483	1.4	2.6	9	2.2	645	66
62	M3HP	280 SMC	3GHP	283 230-●●G	986	93.8	94.3	94.2	0.88	106	7.6	600	1.5	2.6	6	2.85	725	66
72	M3HP	315 SMA	3GHP	313 210-●●G	992	93.8	93.9	93.1	0.84	130	7.2	693	1.3	2.5	7	3.2	830	72
85	M3HP	315 SMB	3GHP	313 220-●●G	991	94.0	94.3	93.8	0.87	148	7.3	819	1.3	2.4	6	4.1	930	72
100	M3HP	315 SMC	3GHP	313 230-●●G	991	94.3	94.7	94.5	0.86	177	6.7	963	1.2	2.2	14	4.9	1000	72
120	M3HP	315 MLA	3GHP	313 410-●●G	991	94.8	95.0	94.6	0.86	212	7.6	1156	1.3	2.5	5	5.8	1150	72
150	M3HP	355 SMA	3GHP	353 210-●●G	993	95.5	95.5	94.9	0.84	268	6.8	1442	1.3	2.6	6	7.9	1510	75
180	M3HP	355 SMB	3GHP	353 220-●●G	994	95.7	95.7	95.0	0.86	315	7.2	1729	1.3	2.6	5	9.7	1680	75
230	M3HP	355 SMC	3GHP	353 420-●●G	993	95.9	96.0	95.5	0.85	405	7.1	2211	1.3	2.5	6	13.5	2180	75
260	M3HP	355 LKA	3GHP	353 810-●●G	993	96.0	96.1	95.5	0.85	458	7.1	2500	1.4	2.6	6	15.5	2500	75
300	M3HP	400 LA	3GHP	403 510-●●G	995	96.5	96.5	96.0	0.84	532	6.9	2879	1.3	2.5	6	17	2900	76
300	M3HP	400 LKA	3GHP	403 810-●●G	995	96.5	96.5	96.0	0.84	532	6.9	2879	1.3	2.5	6	17	2900	76
350	M3HP	400 LB	3GHP	403 520-●●G	995	96.7	96.7	96.2	0.84	620	7.4	3359	1.4	2.6	6	20.5	3150	76
350	M3HP	400 LKB	3GHP	403 820-●●G	995	96.7	96.7	96.2	0.84	620	7.4	3359	1.4	2.6	6	20.5	3150	76

¹⁾ Efficiency class IE1

²⁾ Missing data on request

The two bullets in the product code indicate choice of mounting arrangements, voltage and frequency code (see ordering information page).

I_s / I_N = Starting current

T_l / T_N = Locked rotor torque

T_b / T_N = Pull-out torque

Efficiency values are given according to IEC 60034-2-1; 2007. Please note that the values are not comparable without knowing the testing method.

ABB has calculated the efficiency values according to indirect method, stray load losses (additional losses) determined from measuring.

Increased safety cast iron motors Ex e II T3

Technical data for totally enclosed squirrel cage three phase motors, acc. to EN



IP 55, IC 411; Insulation class F, temperature rise class B

Output		Efficiency IEC 60034-2-1; 2007			Current Torque							Time tE 50Hz	Moment of inertia J = 1/4 GD ² kgm ²	Weight kg	Sound pressure level L _{PA} dB	
kW	Motor type	Product code	Speed r/min	Full load 100%	3/4 load 75%	1/2 load 50%	Power factor cos φ	I _N A	I _s I _N	T _N Nm	T _l T _N					T _b T _N
750 r/min = 8-poles		400 V 50 Hz			GENELEC-design											
0.18	M3HP 80 MA	3GHP 084 310-••														
0.25	M3HP 80 MB	3GHP 084 320-••														
0.37	M3HP 90 SLA	3GHP 094 010-••														
0.55	M3HP 90 SLC	3GHP 094 030-••														
0.75	M3HP 100 LA	3GHP 104 510-••														
1.1	M3HP 100 LB	3GHP 104 520-••														
1.5	M3HP 112 MC	3GHP 114 330-••														
2.2	M3HP 132 SMC	3GHP 134 230-••														
3	M3HP 132 SMD	3GHP 134 240-••														
3.5	M3HP 160 MLA	3GHP 164 410-••H	730	85.6	85.6	83.7	0.70	9.0	6.1	45.7	1.8	3.2	20	0.133	245	55
4.8	M3HP 160 MLB	3GHP 164 420-••H	724	85.8	85.8	83.6	0.70	12.0	5.9	63.3	2.0	3.4	20	0.133	245	55
6.6	M3HP 160 MLC	3GHP 164 430-••H	718	85.5	86.2	85.0	0.71	16.0	5.6	87.7	1.8	3.0	17	0.133	245	55
9.7	M3HP 180 MLB	3GHP 184 420-••H	722	86.6	86.7	85.4	0.79	21.0	6.0	128	1.7	2.8	20	0.245	292	63
15	M3HP 200 MLB	3GHP 204 420-••G	736	90.5	90.7	89.7	0.81	30.5	7.1	194	2.2	3.4	20	0.54	300	64
22	M3HP 225 SMC	3GHP 224 230-••G	735	91.5	91.8	91.0	0.82	43.0	6.8	285	2.1	3.3	21	0.75	375	65
27	M3HP 250 SMA	3GHP 254 210-••G	736	91.7	92.2	91.7	0.83	51.0	6.6	350	1.9	2.8	21	1.25	420	65
32	M3HP 250 SMB	3GHP 254 220-••G	737	92.4	92.7	92.0	0.83	61.0	7.0	414	2.0	2.9	13	1.52	465	65
37	M3HP 280 SMA	3GHP 284 210-••G	741	92.6	92.8	92.1	0.80	72.0	6.7	476	1.5	2.6	10	1.85	605	65
45	M3HP 280 SMB	3GHP 284 220-••G	738	92.8	93.2	93.0	0.82	85.0	6.4	582	1.3	2.6	10	2.2	645	65
55	M3HP 280 SMC	3GHP 284 230-••G	741	93.3	93.5	92.9	0.80	105	7.8	708	1.6	2.8	5	2.85	725	65
75	M3HP 315 SMB	3GHP 314 220-••G	743	94.0	94.3	94.1	0.80	145	6.5	963	1.1	2.2	10	4.1	930	62
90	M3HP 315 SMC	3GHP 314 230-••G	743	94.3	94.5	94.4	0.80	172	6.9	1156	1.2	2.3	6	4.9	1000	64
105	M3HP 315 MLA	3GHP 314 410-••G	743	94.3	94.5	94.3	0.80	200	7.2	1349	1.2	2.3	6	5.8	1150	72
132	M3HP 355 SMB	3GHP 354 220-••G	744	95.3	95.4	94.8	0.83	241	7.6	1694	1.3	2.4	7	9.7	1680	75
150	M3HP 355 SMC	3GHP 354 230-••G	744	95.5	95.5	94.9	0.80	283	7.3	1925	1.3	2.5	10	11.3	1820	75
180	M3HP 355 MLB	3GHP 354 420-••G	743	95.6	95.7	95.2	0.82	330	6.7	2313	1.2	2.4	6	13.5	2180	75
215	M3HP 355 LKB	3GHP 354 820-••G	744	95.8	95.8	95.2	0.81	400	7.5	2759	1.3	2.6	5	16.5	2600	75
230	M3HP 400 LA	3GHP 404 510-••G	745	96.3	96.3	95.7	0.82	420	7.0	2948	1.2	2.5	7	17	2900	71
230	M3HP 400 LKA	3GHP 404 810-••G	745	96.3	96.3	95.7	0.82	420	7.0	2948	1.2	2.5	7	17	2900	71
280	M3HP 400 LB	3GHP 404 520-••G	744	96.3	96.4	96.0	0.83	505	6.7	3593	1.1	2.2	6	21	3200	71
280	M3HP 400 LKB	3GHP 404 820-••G	744	96.3	96.4	96.0	0.83	505	6.7	3593	1.1	2.2	6	21	3200	71
315	M3HP 400 LC	3GHP 404 530-••G	744	96.4	96.5	96.1	0.83	566	6.8	4043	1.2	2.3	6	24	3400	71
315	M3HP 400 LKC	3GHP 404 830-••G	744	96.4	96.5	96.1	0.83	566	6.8	4043	1.2	2.3	6	24	3400	71

¹⁾ Missing data on request

The two bullets in the product code indicate choice of mounting arrangements, voltage and frequency code (see ordering information page).

I_s / I_N = Starting current
T_l / T_N = Locked rotor torque
T_b / T_N = Pull-out torque

Efficiency values are given according to IEC 60034-2-1; 2007. Please note that the values are not comparable without knowing the testing method. ABB has calculated the efficiency values according to indirect method, stray load losses (additional losses) determined from measuring.

Increased safety cast iron motors Ex e II T3

Technical data for totally enclosed squirrel cage three phase motors, acc. to VIK



IP 55, IC 411; Insulation class F, temperature rise class B

Output kW	Motor type	Product code	Speed r/min	Efficiency IEC 60034-2-1; 2007			Power factor cos φ	Current					Time tE 50Hz	Moment of inertia J = 1/4 GD ² kgm ²	Weight kg	Sound pressure level L _{PA} dB
				Full load 100%	3/4 load 75%	1/2 load 50%		I _N A	I _s I _N	T _N Nm	T _I T _N	T _b T _N				
750 r/min = 8-poles			400 V 50 Hz			CENELEC-design										
3.5	M3HP 160 MLA	3GHP 164 410-••H	730	85.7	85.7	83.8	0.70	9.0	6.1	45.7	1.8	3.2	20	0.133	245	55
4.8	M3HP 160 MLB	3GHP 164 420-••H	724	85.9	85.9	83.7	0.70	12	5.9	63.3	2.0	3.4	20	0.133	245	55
6.6	M3HP 160 MLC	3GHP 164 430-••H	718	85.5	86.3	85.0	0.72	16	5.6	87.7	1.8	3.0	17	0.133	245	55
9.7	M3HP 180 MLB	3GHP 184 420-••H	722	86.7	86.8	85.4	0.79	21	6.0	128	1.7	2.8	20	0.245	292	63
13.2	M3HP 200 MLB	3GHP 204 420-••G	734	90.1	90.7	90.1	0.83	26	6.1	171	1.8	3.0	32	0.54	300	64
16.5	M3HP 225 SMB	3GHP 224 220-••G	736	91.3	91.4	90.2	0.81	33	6.6	214	2.0	3.0	25	0.68	350	65
20	M3HP 225 SMC	3GHP 224 230-••G	736	92.0	92.4	91.7	0.82	39	6.9	259	2.1	3.3	24	0.75	375	65
27	M3HP 250 SMA	3GHP 254 210-••G	736	91.7	92.2	91.7	0.83	51	6.6	350	1.9	2.8	16	1.25	420	59
33	M3HP 280 SMA	3GHP 284 210-••G	740	92.8	93.0	92.0	0.80	64	6.9	425	1.4	2.8	12	1.85	605	65
40	M3HP 280 SMB	3GHP 284 220-••G	741	93.1	93.3	92.7	0.80	77	7.0	515	1.5	2.9	15	2.2	645	65
50	M3HP 315 SMA	3GHP 314 210-••G	742	93.5	93.6	92.8	0.82	93	7.1	643	1.2	2.8	15	3.2	830	62
68	M3HP 315 SMB	3GHP 314 220-••G	744	94.0	94.1	93.3	0.79	131	7.2	872	1.2	2.4	12	4.1	930	62
80	M3HP 315 SMC	3GHP 314 230-••G	744	94.3	94.4	93.7	0.80	152	7.7	1026	1.3	2.6	10	4.9	1000	64
95	M3HP 315 MLA	3GHP 314 410-••G	743	94.3	94.6	94.3	0.81	178	7.1	1220	1.1	2.3	7	5.8	1150	72

The two bullets in the product code indicate choice of mounting arrangements, voltage and frequency code (see ordering information page).

I_s / I_N = Starting current
T_I / T_N = Locked rotor torque
T_b / T_N = Pull-out torque

Efficiency values are given according to IEC 60034-2-1; 2007. Please note that the values are not comparable without knowing the testing method. ABB has calculated the efficiency values according to indirect method, stray load losses (additional losses) determined from measuring.

Increased safety cast iron motors variant codes

Code ¹⁾	Variant	Frame Size													
		80	90	100	112	132	160	180	200	225	250	280	315	355	400
Administration															
531	Sea freight packing	P	P	P	P	P	P	P	P	P	P	P	P	P	P
Balancing															
417	Vibration acc. to Grade B (IEC 60034-14).	P	P	P	P	P	P	P	P	P	P	P	P	P	P
423	Balanced without key	P	P	P	P	P	P	P	P	P	P	P	P	P	P
424	Full key balancing.	P	P	P	P	P	P	P	P	P	P	P	P	P	P
Bearings and Lubrication															
036	Transport lock for bearings.	NA	NA	NA	NA	NA	P	P	P	P	P	P	P	P	P
037	Roller bearing at D-end.	NA	NA	NA	NA	NA	P	P	P	P	P	P	P	P	P
040	Heat resistant grease.	S	S	S	S	S	P	P	P	P	P	P	P	P	P
041	Bearings regreasable via grease nipples.	NA	NA	NA	NA	NA	S	S	S	S	S	S	S	S	S
043	SPM compatible nipples for vibration measurement	NA	NA	NA	NA	NA	S	S	S	S	S	S	S	S	S
058	Angular contact bearing at D-end, shaft force away from bearing.	NA	NA	NA	NA	NA	P	P	P	P	P	P	P	P	P
107	Pt100 2-wire in bearings.	NA	NA	NA	NA	NA	P	P	P	P	P	P	P	P	P
128	Double PT100, 2-wire in bearings	NA	NA	NA	NA	NA	P	P	P	P	P	P	P	P	P
129	Double PT100, 3-wire in bearings	NA	NA	NA	NA	NA	P	P	P	P	P	P	P	P	P
130	Pt100 3-wire in bearings.	NA	NA	NA	NA	NA	P	P	P	P	P	P	P	P	P
194	2Z bearings greased for life at both ends.	S	S	S	S	S	P	P	P	P	P	NA	NA	NA	NA
433	Outlet grease collector	NA	NA	NA	NA	NA	NA	NA	NA	NA	NA	P	P	P	P
506	Nipples for vibration measurement : SKF Marlin Quick Connect stud CMSS-2600-3	NA	NA	NA	NA	NA	P	P	P	P	P	P	P	P	P
654	Provision for vibration sensors (M8x1)	NA	NA	NA	NA	NA	P	P	P	P	P	P	P	P	P
795	Lubrication information plate	NA	NA	NA	NA	NA	P	P	P	P	P	S	S	S	S
796	Grease nipples JIS B 1575 PT 1/8 Type A	NA	NA	NA	NA	NA	P	P	P	P	P	P	P	P	P
797	Stainless steel SPM Nipples	NA	NA	NA	NA	NA	P	P	P	P	P	P	P	P	P
798	Stainless steel grease nipples	NA	NA	NA	NA	NA	P	P	P	P	P	P	P	P	P
799	Grease nipples flat type DIN 3404, thread M10x1	NA	NA	NA	NA	NA	P	P	P	P	P	P	P	P	P
800	Grease nipples JIS B 1575 PT 1/8" pin type	NA	NA	NA	NA	NA	P	P	P	P	P	P	P	P	P
Branch standard designs															
178	Stainless steel / acid proof bolts.	S	S	S	S	S	P	P	P	P	P	P	P	P	P
204	Jacking bolts for foot mounted motors.	NA	NA	NA	NA	NA	P	P	P	P	P	P	P	S	S
209	Non-standard voltage or frequency, (special winding).	R	R	R	R	R	P	P	P	P	P	P	P	P	P
425	Corrosion protected stator and rotor core.	S	S	S	S	S	S	S	S	S	S	P	P	P	P
786	Special design shaft upwards (V3, V36, V6) for outdoor mounting.	P	P	P	P	P	P	P	P	P	P	R	R	NA	NA
Cooling system															
044	Unidirectional fan for reduced noise level. Rotation clockwise seen from D-end. Available only for 2-pole motors.	NA	NA	NA	NA	NA	NA	NA	NA	NA	NA	P	P	P	S
045	Unidirectional fan for reduced noise level. Rotation counter clockwise seen from D-end. Available only for 2-pole motors.	NA	NA	NA	NA	NA	NA	NA	NA	NA	NA	P	P	P	S
068	Light alloy metal fan	P	P	P	P	P	P	P	P	P	P	P	P	P	P
206	Steel fan	NA	NA	NA	NA	NA	P	P	P	P	P	P	P	P	P
791	Stainless steel fan cover	NA	NA	NA	NA	NA	NA	NA	P	P	P	P	P	P	P

¹⁾ Certain variant codes cannot be used simultaneously.

S = Included as standard
P = New manufacture only
M = On modification of a stocked motor; or on new manufacture, the number of number per order may be limited.
R = On request
NA = Not applicable.

Code ¹⁾	Variant	Frame Size													
		80	90	100	112	132	160	180	200	225	250	280	315	355	400
Coupling															
035	Assembly of customer supplied coupling-half.	NA	NA	NA	NA	NA	NA	NA	NA	NA	NA	P	P	P	P
Documentation															
141	Binding dimension drawing.	P	P	P	P	P	P	P	P	P	P	P	P	P	P
Drain holes															
065	Plugged existing drain holes.	NA	NA	NA	NA	NA	P	P	P	P	P	P	P	P	P
448	Draining holes with metal plugs.	NA	NA	NA	NA	NA	P	P	P	P	P	P	P	P	P
Earthing Bolt															
067	External earthing bolt.	S	S	S	S	S	S	S	S	S	S	S	S	S	S
Hazardous Environments															
272	Ex e II acc. to ATEX directive 94/9/EC , temp. class T2.	NA	NA	NA	NA	NA	P	P	P	P	P	P	P	P	P
Heating elements															
450	Heating element, 100-120V.	P	P	P	P	P	P	P	P	P	P	P	P	P	P
451	Heating element, 200-240V.	P	P	P	P	P	P	P	P	P	P	P	P	P	P
Mounting arrangements															
008	IM 2101 foot/flange mounted, IEC flange, from IM 1001 (B34 from B3).	P	P	P	P	P	NA	NA	NA	NA	NA	NA	NA	NA	NA
009	IM 2001 foot/flange mounted, IEC flange, from IM 1001 (B35 from B3).	P	P	P	P	P	P	P	P	P	P	P	P	P	P
047	IM 3601 flange mounted, IEC flange, from IM 3001 (B14 from B5).	P	P	P	P	P	NA	NA	NA	NA	NA	NA	NA	NA	NA
066	Modified for non-standard mounting position (please specify IM xxxx), (must be ordered for all mounting arrangements excluding IM B3 (1001), IM B5 (3001), IM B35 (2001), B34 (2101) & B14 (3601).	P	P	P	P	P	P	P	P	P	P	P	P	P	P
228	Flange FF 130.	P	P	P	P	NA	NA	NA	NA	NA	NA	NA	NA	NA	NA
229	Flange FT 130.	P	P	P	P	NA	NA	NA	NA	NA	NA	NA	NA	NA	NA
235	Flange FF 165.	NA	P	P	P	P	NA	NA	NA	NA	NA	NA	NA	NA	NA
236	Flange FT 165.	NA	P	P	P	P	NA	NA	NA	NA	NA	NA	NA	NA	NA
245	Flange FF 215.	NA	NA	S	S	P	NA	NA	NA	NA	NA	NA	NA	NA	NA
246	Flange FT 215.	NA	NA	P	P	P	NA	NA	NA	NA	NA	NA	NA	NA	NA
255	Flange FF 265.	NA	NA	NA	NA	S	NA	NA	NA	NA	NA	NA	NA	NA	NA
256	Flange FT 265.	NA	NA	NA	NA	P	NA	NA	NA	NA	NA	NA	NA	NA	NA
257	Flange FF 100.	P	NA	NA	NA	NA	NA	NA	NA	NA	NA	NA	NA	NA	NA
258	Flange FT 100.	P	NA	NA	NA	NA	NA	NA	NA	NA	NA	NA	NA	NA	NA
259	Flange FF 115.	P	P	NA	NA	NA	NA	NA	NA	NA	NA	NA	NA	NA	NA
260	Flange FT 115.	P	P	NA	NA	NA	NA	NA	NA	NA	NA	NA	NA	NA	NA
309	IM 1001 foot mounted, from IM 3001 (B3 from B5).	NA	NA	NA	NA	NA	NA	NA	NA	NA	NA	NA	NA	NA	NA
Painting															
114	Special paint colour, standard grade.	P	P	P	P	P	P	P	P	P	P	P	P	P	P
115	Painting system C4M acc. To ISO 12944-5: 2007	P	P	P	P	P	P	P	P	P	P	P	P	P	P
168	Primer paint only.	P	P	P	P	P	P	P	P	P	P	P	P	P	P
754	Painting system C5M acc. to ISO 12944-5:2007	P	P	P	P	P	P	P	P	P	P	P	P	P	P
755	Aluminium metallizing and painting according to NORSOK M501 revision 5, Method 2A (only available color RAL 7038)	P	P	P	P	P	P	P	P	P	P	P	P	P	P

¹⁾ Certain variant codes cannot be used simultaneously.

S = Included as standard

P = New manufacture only

M = On modification of a stocked motor; or on new manufacture, the number of number per order may be limited.

R = On request

NA = Not applicable.

Code ¹⁾	Variant	Frame Size													
		80	90	100	112	132	160	180	200	225	250	280	315	355	400
Protection															
005	Metal protective roof, vertical motor, shaft down.	P	P	P	P	P	P	P	P	P	P	P	P	P	P
072	Radial seal at D-end.	P	P	P	P	P	P	P	P	P	P	P	P	NA	NA
073	Sealed against oil at D-end.	P	P	P	P	P	P	P	P	P	P	P	P	P	P
076	Draining holes with plugs in open position.	P	P	P	P	P	S	S	S	S	S	S	S	S	S
158	Degree of protection IP65.	P	P	P	P	P	P	P	P	P	P	P	P	P	P
401	Protective roof, horizontal motor.	P	P	P	P	P	P	P	P	P	P	P	P	P	P
403	Degree of protection IP56.	P	P	P	P	P	P	P	P	P	P	P	P	P	P
434	Degree of protection IP56, open deck.	NA	NA	NA	NA	NA	P	P	P	P	P	P	P	P	P
783	Labyrinth sealing at D-end.	P	P	P	P	P	P	P	P	P	P	P	P	S	S
Rating & instruction plates															
002	Restamping voltage, frequency and output, continuous duty.	R	R	R	R	R	P	P	P	P	P	P	P	P	P
004	Additional text on std rating plate (max 12 digits on free text line).	P	P	P	P	P	P	P	P	P	P	P	P	P	P
126	Tag plate	P	P	P	P	P	P	P	P	P	P	P	P	P	P
135	Mounting of additional identification plate, stainless.	P	P	P	P	P	P	P	P	P	P	P	P	P	P
139	Additional identification plate delivered loose.	P	P	P	P	P	P	P	P	P	P	P	P	P	P
161	Additional rating plate delivered loose.	P	P	P	P	P	P	P	P	P	P	P	P	P	P
Shaft & rotor															
069	Two shaft extensions as per basic catalogue.	P	P	P	P	P	P	P	P	P	P	P	P	P	P
070	One or two special shaft extensions, standard shaft material.	P	P	P	P	P	P	P	P	P	P	P	P	P	P
164	Shaft extension with closed key-way.	S	S	S	S	S	S	S	S	S	S	P	P	P	P
165	Shaft extension with open key-way.	P	P	P	P	P	P	P	P	P	P	S	S	S	S
410	Stainless steel shaft (standard or non-standard design).	R	R	R	R	R	R	R	R	R	R	P	P	P	P
Standards and Regulations															
151	Design according to SHELL DEP 33.66.05.31-Gen. June 2007	P	P	P	P	P	P	P	P	P	P	P	P	P	P
504	Design according to Neste OY & Jacobs, specification N-114 E, rev 3, 21.03.2002 with SPM adapter	P	P	P	P	P	P	P	P	P	P	P	P	P	P
774	Design according to NORSOK (Norwegian Territorial Waters)excluding surface treatment.	P	P	P	P	P	P	P	P	P	P	P	P	P	P
775	Design according to SHELL DEP 33.66.05.31-Gen. January 1999 design.	P	P	P	P	P	P	P	P	P	P	P	P	P	P
779	SASO Export/Import Certificate (Saudi Arabia)	P	P	P	P	P	P	P	P	P	P	P	P	P	P
Stator winding temperature sensors															
435	PTC - thermistors (3 in series), 130°C, in stator winding.	S	S	S	S	S	S	S	S	S	S	S	S	S	S
440	PTC - thermistors (3 in series, 110°C & 3 in series, 130°C), in stator winding.	P	P	P	P	P	P	P	P	P	P	P	P	P	P
445	Pt-100 2-wire in stator winding, 1 per phase.	P	P	P	P	P	P	P	P	P	P	P	P	P	P
446	Pt-100 2-wire in stator winding, 2 per phase.	NA	NA	NA	NA	NA	P	P	P	P	P	P	P	P	P
502	Pt-100 3-wire in stator winding, 1 per phase.	NA	NA	NA	NA	NA	P	P	P	P	P	P	P	P	P
503	Pt-100 3-wire in stator winding, 2 per phase.	NA	NA	NA	NA	NA	P	P	P	P	P	P	P	P	P

¹⁾ Certain variant codes cannot be used simultaneously.

S = Included as standard

P = New manufacture only

M = On modification of a stocked motor; or on new manufacture, the number of number per order may be limited.

R = On request

NA = Not applicable.

Code ¹⁾	Variant	Frame Size													
		80	90	100	112	132	160	180	200	225	250	280	315	355	400
Terminal box															
021	Terminal box LHS (seen from D-end).	NA	NA	NA	NA	NA	P	P	P	P	P	P	P	P	P
022	Cable entry LHS (seen from D-end).	P	P	P	P	P	P	P	P	P	P	P	P	P	P
157	Terminal box degree of protection IP65.	P	P	P	P	P	P	P	P	P	P	P	P	P	P
180	Terminal box RHS (seen from D-end).	NA	NA	NA	NA	NA	P	P	P	P	P	P	P	P	P
277	Cable sealing end unit, size small for C-opening	NA	NA	NA	NA	NA	NA	NA	NA	NA	NA	P	NA	NA	NA
278	Cable sealing end unit, size medium for D-opening	NA	NA	NA	NA	NA	NA	NA	NA	NA	NA	NA	P	P	P
279	Cable sealing end unit, size large for D-opening	NA	NA	NA	NA	NA	NA	NA	NA	NA	NA	NA	P	P	P
292	Adapter C-C	NA	NA	NA	NA	NA	NA	NA	NA	NA	NA	P	NA	NA	NA
293	Adapter D-D	NA	NA	NA	NA	NA	NA	NA	NA	NA	NA	NA	P	P	NA
294	Adapter E-D	NA	NA	NA	NA	NA	NA	NA	NA	NA	NA	NA	P	P	P
295	Adapter E-2D	NA	NA	NA	NA	NA	NA	NA	NA	NA	NA	NA	P	P	P
300	Increased single core cross section	P	P	P	P	P	P	P	P	P	P	P	P	P	P
380	Separate terminal box for temperature detectors, std. material	NA	NA	NA	NA	NA	P	P	P	P	P	P	P	P	P
400	4 x 90 degr turnable terminal box.	S	S	S	S	S	S	S	S	S	S	S	S	NA	NA
402	Terminal box adapted for Al cables.	NA	NA	NA	NA	NA	NA	NA	NA	NA	NA	S	S	S	S
413	Extended cable connection, no terminal box.	NA	NA	NA	NA	NA	NA	NA	NA	NA	NA	P	P	P	P
418	Separate terminal box for auxiliaries, standard material.	NA	NA	NA	NA	NA	P	P	P	P	P	P	P	P	P
466	Terminal box at N-end.	NA	NA	NA	NA	NA	NA	NA	P	P	P	P	P	P	P
468	Cable entry from D-end.	P	P	P	P	P	P	P	P	P	P	P	P	P	P
469	Cable entry from N-end.	P	P	P	P	P	P	P	P	P	P	P	P	P	P
567	Separate terminal box material: Cast Iron	NA	NA	NA	NA	NA	P	P	P	P	P	P	P	P	P
568	Separate terminal box for heating elements, std. material	NA	NA	NA	NA	NA	P	P	P	P	P	P	P	P	P
569	Separate terminal box for brakes	NA	NA	NA	NA	NA	P	P	P	P	P	NA	NA	NA	NA
729	Aluminum non-drilled flange for cable glands	P	P	P	P	P	P	P	P	P	P	P	P	P	P
730	Prepared for NPT cable glands	P	P	P	P	P	P	P	P	P	P	P	P	P	P
732	Standard cable gland, Ex d IIB, armoured cable.	P	P	P	P	P	P	P	P	P	P	P	P	P	P
733	Standard cable gland, Ex d IIB, non-armoured cable.	P	P	P	P	P	P	P	P	P	P	P	P	P	P
736	Standard cable gland Ex e acc. to EN-standards.	S	S	S	S	S	S	S	S	S	S	S	S	S	S
737	Standard cable gland Ex e with clamping device acc. to EN-standards.	P	P	P	P	P	P	P	P	P	P	P	P	P	P
743	Painted non-drilled flange in steel for cable glands	P	P	P	P	P	P	P	P	P	P	P	P	P	P
744	Stainless steel non-drilled flange for cable glands.	P	P	P	P	P	P	P	P	P	P	P	P	P	P
745	Painted steel flange equipped with nickle plated brass cable glands	P	P	P	P	P	P	P	P	P	P	P	P	P	P
746	Stainless steel cable flange equipped with standard nickle plated brass cable glands	P	P	P	P	P	P	P	P	P	P	P	P	P	P
Testing															
145	Type test report from a catalogue motor, 400V 50Hz.	P	P	P	P	P	P	P	P	P	P	P	P	P	P
146	Type test with report for one motor from specific delivery batch.	P	P	P	P	P	P	P	P	P	P	P	P	P	P
148	Routine test report.	P	P	P	P	P	P	P	P	P	P	P	P	P	P
150	Customer witnessed testing. Specify test procedure with other codes.	P	P	P	P	P	P	P	P	P	P	P	P	P	P

¹⁾ Certain variant codes cannot be used simultaneously.

S = Included as standard

P = New manufacture only

M = On modification of a stocked motor; or on new manufacture, the number of number per order may be limited.

R = On request

NA = Not applicable.

Code ¹⁾	Variant	Frame Size													
		80	90	100	112	132	160	180	200	225	250	280	315	355	400
222	Torque/speed curve, type test and multi-point load test with report for one motor from specific delivery batch.	P	P	P	P	P	P	P	P	P	P	P	P	P	P
760	Vibration level test	P	P	P	P	P	P	P	P	P	P	P	P	P	P
761	Vibration spectrum test for one motor from specific delivery batch.	P	P	P	P	P	P	P	P	P	P	P	P	P	P
762	Noise level test for one motor from specific delivery batch.	P	P	P	P	P	P	P	P	P	P	P	P	P	P
763	Noise spectrum test for one motor from specific delivery batch.	P	P	P	P	P	P	P	P	P	P	P	P	P	P

¹⁾ Certain variant codes cannot be used simultaneously.

S = Included as standard
P = New manufacture only
M = On modification of a stocked motor; or on new manufacture, the number of number per order may be limited.
R = On request
NA = Not applicable.

Increased safety motors, cast iron frame

Dimension drawings

Foot-mounted motor IM 1001, IM B3

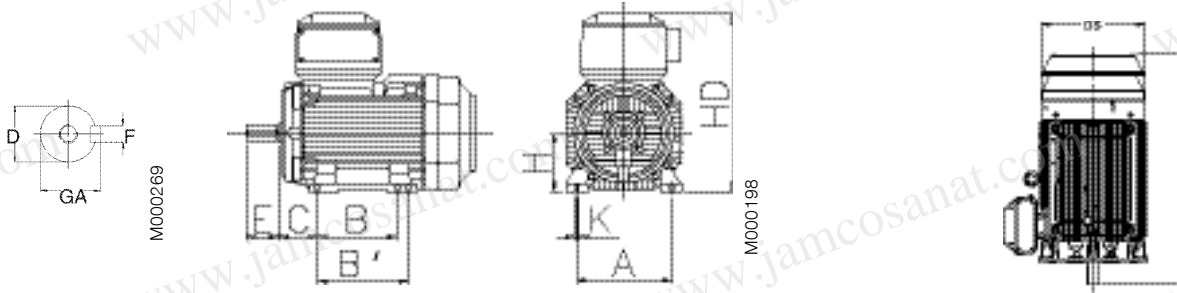

Protective roof,
variant code 005

Flange-mounted motor IM 3001, IM B5

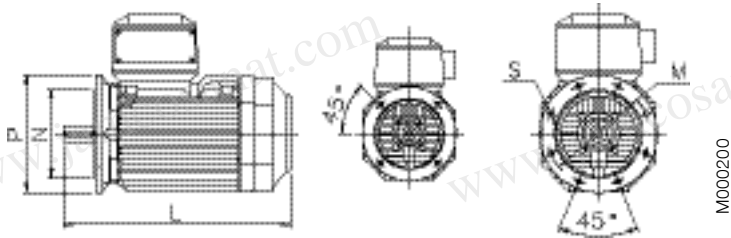

Sizes 80-200

Sizes 225-400

Motor size	IM 1001, IM B3 AND IM 3001, IM B5										IM 1001, IM B3					IM 3001, IM B5					Protective roof				
	D poles		GA poles		F poles		E poles		L max poles		O	A	B	B'	C	HD	K	H	M	N	P	S	DS	LS poles	
	2	4-8	2	4-8	2	4-8	2	4-8	2	4-8													2	4-8	
80	19	19	21.5	21.5	6	6	40	40	340	340	20	125	100	125	50	235	10	80	165	130	200	12	160	360	360
90	24	24	27	27	8	8	50	50	405	405	20	140	100	125	56	260	10	90	165	130	200	12	180	430	430
100	28	28	31	31	8	8	60	60	480	480	25	160	140	-	63	280	12	100	215	180	250	14.5	195	505	505
112	28	28	31	31	8	8	60	60	480	480	25	190	140	-	70	295	12	112	215	180	250	14.5	195	505	505
132	38	38	41	41	10	10	80	80	560	560	30	216	140	178	89	340	12	132	265	230	300	14.5	260	590	590
160	42	42	45	45	12	12	110	110	808	808	45	254	210	254	108	499	14.5	160	300	250	350	18.5	328	756	756
180	48	48	51.5	51.5	14	14	110	110	826	826	50	279	241	279	121	539	14.5	180	300	250	350	18.5	359	756	756
200	55	55	59	59	16	16	110	110	774	774	70	318	267	305	133	536	18.5	200	350	300	400	18.5	414	844	844
225	55	60	59	64	16	18	110	140	841	871	80	356	286	311	149	583	18.5	225	400	350	450	18.5	462	921	951
250	60	65	64	69	18	18	140	140	875	875	90	406	311	349	168	646	24	250	500	450	550	18.5	506	965	965
280	65	75	69	79.5	18	20	140	140	1088	1088	100	457	368	419	190	759	24	280	500	450	550	18	555	1190	1190
315 SM	65	80	69	85	18	22	140	170	1174	1204	115	508	406	457	216	852	30	315	600	550	660	23	624	1290	1320
315 ML	65	90	69	95	18	25	140	170	1285	1315	115	508	457	508	216	852	30	315	600	550	660	23	624	1401	1431
355 SM	70	100	62.5	90	20	28	140	210	1409	1479	130	610	500	560	254	958	35	355	740	680	800	23	720	1476	1546
355 ML	70	100	62.5	90	20	28	140	210	1514	1584	130	610	560	630	254	958	35	355	740	680	800	23	720	1528	1703
355 LK	70	100	62.5	90	20	28	140	210	1764	1834	130	610	710	900	254	958	35	355	740	680	800	23	720	1633	1703
400 L	80	110	85	126	22	28	170	210	1851	1891	150	710	900	1000	224	1045	35	400	940	880	1000	28	810	1860	1900
400 LK	80	100	85	106	22	28	170	210	1851	1891	150	686	710	800	280	1045	35	400	740	680	800	24	810	1860	1900

IM 3601, B14 - Available flange alternatives ; see also variant codes.

Flange size	Variant code	Flange dimensions				Motor size 80-132					S = Standard flange M = Option NA = Not possible
		P	M	N	S	80	90	100	112	132	
FT100	258	120	100	80	M6	S	NA	NA	NA	NA	
FT115	260	140	115	95	M8	P	S	NA	NA	NA	
FT130	229	160	130	110	M8	P	P	S	S	NA	
FT165	236	200	165	130	M10	NA	NA	NA	NA	S	
FT215	246	250	215	180	M12	NA	NA	P	P	P	
FT265	256	300	265	230	M12	NA	NA	NA	NA	P	
FT100	257	120	100	80	M7	S	M	NA	NA	NA	
FT115	259	140	115	95	M10	M	S	NA	NA	NA	
FT130	228	160	130	110	M10	M	M	S	S	NA	
FT165	235	200	165	130	M12	M	M	M	M	S	
FT215	245	250	215	180	M14.5	NA	NA	M	M	M	
FT265	255	300	265	230	M14.5	NA	NA	NA	NA	M	

Tolerances:

- A, B ± 0,8
- D, DA ISO k6 < Ø 50mm
- ISO m6 > Ø 50mm
- F, FA ISO h9
- H -0.5
- N ISO j6
- C, CA ± 0.8

Above table gives the main dimensions in mm. For detailed drawings please see our web-pages www.abb.com/motors&generators or contact ABB.

Increased safety motor construction

Typical exploded view of cast iron motors, frame size 315

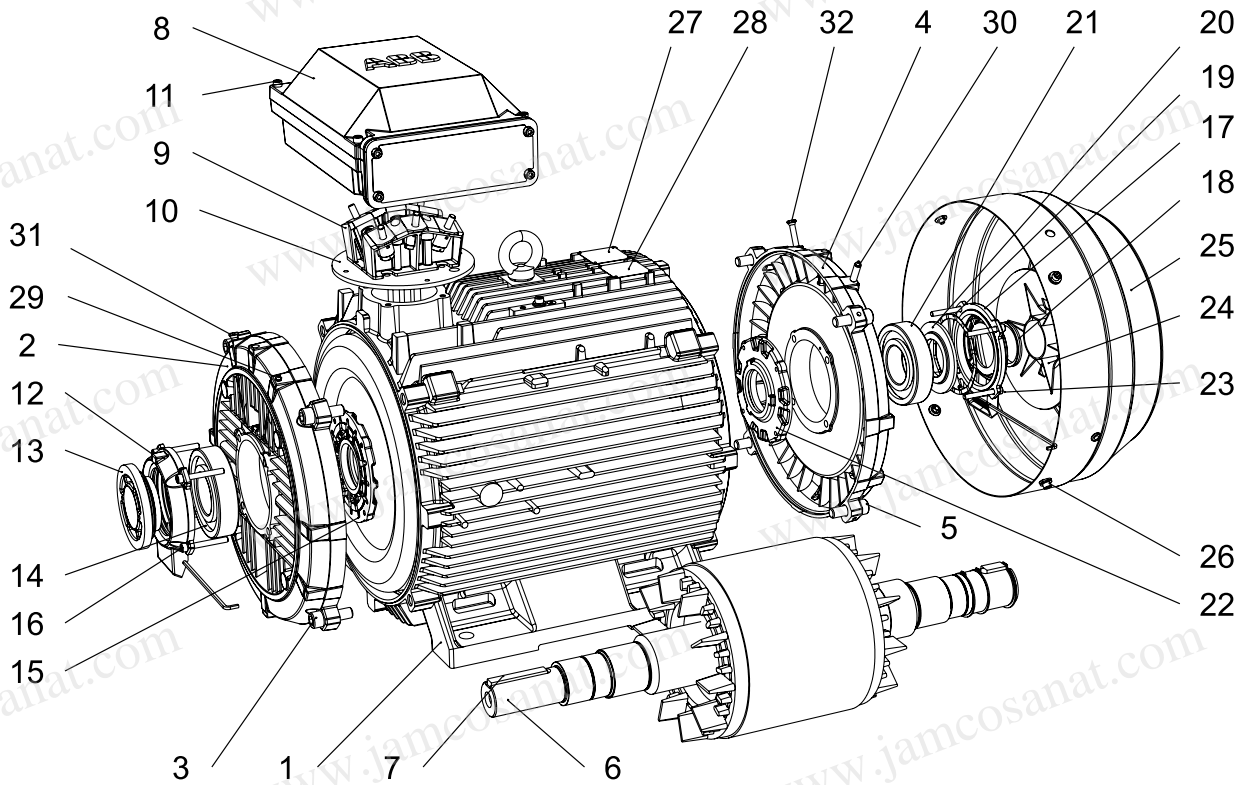

- | | | | |
|----|--|----|---------------------------------|
| 1 | Stator frame | 17 | Outer bearing cover, N-end |
| 2 | Endshield, D-end | 18 | Seal, N-end |
| 3 | Screws for endshield, D-end | 19 | Wave spring |
| 4 | Endshield, N-end | 20 | Valve disc, N-end |
| 5 | Screws for endshield, N-end | 21 | Bearing, N-end |
| 6 | Rotor with shaft | 22 | Inner bearing cover, N-end |
| 7 | Key, D-end | 23 | Screws for bearing cover, N-end |
| 8 | Terminal box | 24 | Fan |
| 9 | Terminal board | 25 | Fan cover |
| 10 | Intermediate flange | 26 | Screws for fan cover |
| 11 | Screws for terminal box cover | 27 | Rating plate |
| 12 | Outer bearing cover, D-end | 28 | Regreasing plate |
| 13 | Valve disc with labyrinth seal, D-end;
standard in 2-pole motors (V-ring in 4-8 pole) | 29 | Grease nipple, D-end |
| 14 | Bearing, D-end | 30 | Grease nipple, N-end |
| 15 | Inner bearing cover, D-end | 31 | SPM nipple, D-end |
| 16 | Screws for bearing cover, D-end | 32 | SPM nipple, N-end |

M000220

Certificate examples

L C I E

1 **ATTESTATION D'EXAMEN CE DE TYPE**

2 Appareil ou système de protection destiné à être utilisé en atmosphères explosibles (Directive 94/9/CE)

3 Numéro de l'attestation d'examen CE de type LCIE 09 ATEX 3023

4 Appareil ou système de protection :
Moteur asynchrone
Type : M3HP180... (Génération H)

5 Demandeur :
ABB Oy Motors
Strombergin Puistotie 5A
FIN - 65101 VAASA - Finland

6 Fabricant :
ABB Oy Motors
Strombergin Puistotie 5A
FIN - 65101 VAASA - Finland

7 Cet appareil ou système de protection et ses variantes éventuelles acceptées sont décrits dans l'annexe de la présente attestation et dans les documents décrits cités en référence.

8 Le LCIE, organisme notifié sous la référence 0081 conformément à l'article 9 de la directive 94/9/CE du Parlement européen et du Conseil du 23 mars 1994, certifie que cet appareil ou système de protection est conforme aux exigences essentielles de sécurité et de santé pour la conception et la construction d'appareils et de systèmes de protection destinés à être utilisés en atmosphères explosibles, données dans l'annexe II de la directive. Les résultats des vérifications et essais figurent dans le rapport confidentiel N° 91307-582851.

9 Le respect des exigences essentielles de sécurité et de santé est assuré par la conformité à :
- EN 60079-0 (2006) - EN 60079-7 (2007)
- EN 61241-0 (2006) - EN 61241-1 (2004)

10 Le signe X lorsqu'il est placé à la suite du numéro de l'attestation, indique que cet appareil ou système de protection est soumis aux conditions spéciales pour une utilisation sûre, mentionnées dans l'annexe de la présente attestation.

11 Cette attestation d'examen CE de type concerne uniquement la conception et la construction de l'appareil ou du système de protection spécifié, conformément à l'annexe III de la directive 94/9/CE. Des exigences supplémentaires de la directive sont applicables pour la fabrication et la fourniture de l'appareil ou du système de protection. Ces dernières ne sont pas couvertes par la présente attestation.

12 Le marquage de l'appareil ou du système de protection doit comporter les informations détaillées au point 15.

1 **EC TYPE EXAMINATION CERTIFICATE**

2 Equipment or protective system intended for use in potentially explosive atmospheres (Directive 94/9/EC)

3 EC type examination certificate number LCIE 09 ATEX 3023

4 Equipment or protective system :
Asynchronous motor
Type : M3HP180... (Generation H)

5 Applicant :
ABB Oy Motors
Strombergin Puistotie 5A
FIN - 65101 VAASA - Finland

6 Manufacturer :
ABB Oy Motors
Strombergin Puistotie 5A
FIN - 65101 VAASA - Finland

7 This equipment or protective system and any acceptable variation thereto are specified in the schedule to this certificate and the documents therein referred to.

8 LCIE, notified body number 0081 in accordance with article 9 of the Directive 94/9/EC of the European Parliament and the Council of 23 March 1994, certifies that the equipment or protective system has been found to comply with the essential Health and Safety Requirements relating to the design and construction of equipment and protective systems intended for use in potentially explosive atmospheres, given in Annex II to the Directive. The examination and test results are recorded in confidential report N° 91307-582851.

9 Compliance with the Essential Health and Safety Requirements has been assured by compliance with :
- EN 60079-0 (2006) - EN 60079-7 (2007)
- EN 61241-0 (2006) - EN 61241-1 (2004)

10 If the sign X is placed after the certificate number, it indicates that the equipment or protective system is subject to special conditions for safe use specified in the schedule to this certificate.

11 This EC type examination certificate relates only to the design and construction of this specified equipment or protective system in accordance with annex III to the Directive 94/9/EC. Further requirements of the directive apply to the manufacturing process and supply of this equipment or protective system. These are not covered by this certificate.

12 The marking of the equipment or protective system shall include the information as detailed at 15.

Marc GILLAUX
Responsible de certification ATEX
ATEX certification manager

Fontenay-aux-Roses, le 9 avril 2009

Scale 1/2000
The LCIE facility applies only on the French territory. This document may only be reproduced or translated without any change.

LABORATORIO OFICIAL J. M. MADARIAGA

EC-TYPE EXAMINATION CERTIFICATE SUPPLEMENT

(1) Equipment or protective system intended for use in potentially explosive atmospheres (Directive 94/9/EC)

(2) Supplement no. 5 to EC-Type Examination Certificate number: **LOM 99ATEX2011**

(3) Equipment or Protection System: Electric motor Series M3AAL 90 - 100

(4) Applicant: Asea Brown Boveri, S.A. Automation Products-Fabrica Motores

(5) Address: Isla de Buda, 55 08192 SANT QUIRZE DEL VALLES (Barcelona) SPAIN

(6) Test report no: LOM 06.241 BF

(7) Variations included in this certificate:
- Change in the manufacturer name
- New standards update: EN 60079-0: 2004 EN 60079-7: 2003
Motor characteristics remains unchanged

(8) Variations in the marking:
Ex II 2G Ex e II T2, T3

(9) Descriptive documents:
CD-ROM (marking drawings) Rev. Date: 2006/06-16

Carlos Fernández Ramón
DIRECTOR OF THE LABORATORY

Angel Vega Remesal
Head of ATEX area

Madrid, 21st July, 2006

This supplement must be an inseparable part together with the base certificate LOM 99ATEX2011 (This document may only be reproduced in its entirety and without any change). This Certificate is a translation from the original in Spanish. The LOM facility applies only on the Spanish territory. Page 1/1

EC Declaration of Conformity

The Manufacturer:
ABB Oy
Motors
P.O. Box 633
Strombergin puistotie 5A
FIN - 65101 Vaasa, Finland

hereby declares that

the products:
3-phase induction motors, series M2GP, M3JP, M3JC, M3KP, M3KC, M3GP, M3HP and M3LP; as listed on page 2 in this document, fulfil provisions of the relevant Council Directives:

Directive 94/9/EC (ATEX of 23rd March 1994)

by applying the following harmonized standards:
EN 60079-0 (2006), EN 60079-1 (2007), EN 60079-7 (2007), EN 60079-15 (2005), EN 61241-0 (2006), EN 61241-1 (2004).

ABB Oy Motors declare on it's sole responsibility,
- that the state of the art of these standards do not modify the result of the assessment carried out by LCIE which issued the EC type examination certificates according to former editions of the standard series.
- that listed motors conform to the requirements of annex I of the directive 94/9/EC clause 1.2.7 by applying the standards serie EN 60034.

Directive 2005/32/EC (EuP of 6th July 2005)

by fulfilling the requirements of the standard EN 60034-30 (March 2009) in respect of the efficiency class.

Note: When installing motors for converter supply applications additional requirements must be respected regarding the motor as well as the installation, as described in the appropriate dedicated addendum.

Signed by: _____
Title: Jouni Ikaheimo
Product Development Manager

Date: April 29th, 2010 3GZF500930-988

ABB Oy

Motors
Postal address
P.O. Box 633
FI-65101 Vaasa
FINLAND

Visiting Address
Strombergin Puistotie 5 A
FI-65320 Vaasa
FINLAND

Telephone
+358 10 22 11
Telefax
+358 10 22 47372

Internet
www.abb.fi
e-mail:
first.name.last.name
@fi.abb.com

Business Identity Code:
0763403-0
Domicile: Helsinki

2(2)

2010-04-29

Certificates: 3-phase induction motors, series M2GP, M3JP, M3KP, M3GP, M3HP, M3LP

Group & category, temperature class, protection	Motor type, IEC frame size	Certification number	Year of CE-marking	
Flameproof II 2 G Ex d II B / II C T1-T8 II 2 G Ex e II B / II C T1-T8	M3JP/M3KP 90	LCIE 04 ATEX 6150	2004	
	M3JP/M3KP 90	LCIE 04 ATEX 6151	2004	
	M3JP/M3KP 100-112	LCIE 04 ATEX 6152	2004	
	M3JP/M3KP 132	LCIE 04 ATEX 6081	2004	
	M3JP/M3KP 160	LCIE 00 ATEX 6023	2000	
	M3JP/M3KP 180	LCIE 00 ATEX 6028	2000	
	II 2 D Ex ID A21 / IP 65	M3JP/M3KP 160 Gen.H	LCIE 09 ATEX 3004X	2009
	M3JP/M3KP 180 Gen.H	LCIE 09 ATEX 3005X	2009	
	M3JP/M3KP 200	LCIE 00 ATEX 6027	2000	
	II 3 D Ex ID A22 / IP 55, IP65 (3D not for M3JP/M3KP160-180 Gen.H)	M3JP/M3KP 225	LCIE 00 ATEX 6029	2000
	M3JP/M3KP 250	LCIE 00 ATEX 6030	2000	
	M3JP/M3KP 280	LCIE 01 ATEX 6078	2001	
M3JP/M3KP 315	LCIE 01 ATEX 6079	2001		
M3JP/M3KP 355	LCIE 03 ATEX 6060	2003		
M3JP/M3KP 400	LCIE 04 ATEX 6087	2004		
Increased safety II 2 G Ex e II T2-T3 In addition for M3HP160 - 400: II 2 D Ex ID A21	M3HP 90-90	LCIE 06 ATEX 6047	2006	
	M3HP 100-112	LCIE 06 ATEX 6048	2006	
	M3HP 132	LCIE 06 ATEX 6049	2006	
	M3HP 160	LCIE 01 ATEX 6015	2001	
	M3HP 180	LCIE 01 ATEX 6016	2001	
	M3HP 160 Gen.H	LCIE 09 ATEX 3022	2009	
	M3HP 180 Gen.H	LCIE 09 ATEX 3023	2009	
	M3HP 200	LCIE 01 ATEX 6022	2001	
	M3HP 225	LCIE 01 ATEX 6023	2001	
	M3HP 250	LCIE 01 ATEX 6024	2001	
	M3HP 280	LCIE 02 ATEX 6071	2002	
	M3HP 315	LCIE 02 ATEX 6072	2002	
	M3HP 355	LCIE 03 ATEX 6022	2003	
	M3HP 400	LCIE 04 ATEX 6013	2004	
	M2GP 71-250	LCIE 05 ATEX 6160	2005	
M3GP 90 - 400	LCIE 06 ATEX 6089	2006		
Non-sparking II 3G Ex nA II T2 - T3	M3GP 160 - 180 Gen.H	LCIE 09 ATEX 1010 *	2009	
	M3GPM3LP 450	LCIE 06 ATEX 6088	2006	
Dust ignition II 2 D Ex ID A21 IP 65	M3GP 160 - 180 Gen.H	LCIE 09 ATEX 3016	2009	
Dust ignition II 3 D Ex ID A22	M3GP 160 - 180 Gen.H	LCIE 09 ATEX 1010 *	2009	
	M3GPM3LP 450	LCIE 06 ATEX 6088	2006	
Dust ignition II 2 D Ex ID A21 IP 65 or II 3 D Ex ID A22 IP 55, IP65	M2GP 71-250	LCIE 05 ATEX 6160	2005	
	M3GP 90-400	LCIE 06 ATEX 6089	2006	

1) Notified Body (ExNB) LCIE (0081), Av. Du Général Leclerc, 83, 92266 Fontenay-aux-Roses, France
2) *) Voluntary Type Examination Certificate for equipment category 3

3GZF500930-988

M000728

M000729

M000725-1

M000725-2

Increased safety motors with cast iron frame in brief, basic design

Motor size		80	90	100	112	132	160	180	
Stator	Material	Cast iron, at least EN-GJL-200							
	Paint colour shade	Blue, Munsell 8B 4.5/3.25 / NCS 4822 B05G							
	Corrosion class	C3 medium according to ISO/EN 12944-5							
Bearing end shields	Material	Cast iron, at least EN-GJL-200							
	Paint color shade	Blue, Munsell 8B 4.5/3.25 / NCS 4822 B05G							
	Corrosion class	C3 medium according to ISO/EN 12944-5							
Bearings	D-end	2-pole	6204-2Z/C3	6205-2Z/C3	6206-2Z/C3	6206-2Z/C3	6208-2Z/C3	6309/C3	6310/C3
		4-12 -pole	6204-2Z/C3	6205-2Z/C3	6206-2Z/C3	6206-2Z/C3	6208-2Z/C3	6309/C3	6310/C3
	N-end	2-pole	6204-2Z/C3	6205-2Z/C3	6206-2Z/C3	6206-2Z/C3	6208-2Z/C3	6309/C3	6309/C3
		4-12 -pole	6204-2Z/C3	6205-2Z/C3	6206-2Z/C3	6206-2Z/C3	6208-2Z/C3	6309/C3	6309/C3
Axially-locked bearings	Inner bearing cover	As standard, locked at D-end							
Bearing seal		Gamma ring as standard							
Lubrication		Permanent grease lubrication.					Regreasable bearings		
SPM-nipples		-					As standard		
Rating plate	Material	Stainless steel							
Terminal box	Frame material	Cast iron, at least EN-GJL-200							
	Cover material	Cast iron, at least EN-GJL-200							
	Cover screws material	Acidproof steel A4-80					Steel 8.8, zinc electroplated and chromated		
Connections	Cable entries	1xM25x1.5			2xM32x1.5		2xM40x1.5		
	Terminals	6 terminals for connection with cable lugs (not included)							
Fan	Material	Polyamide. Reinforced with glass fibre.					Polypropylene. Reinforced with glass fibre.		
Fan cover	Material	Steel					Hot dip galvanized steel		
	Paint colour shade	Blue, Munsell 8B 4.5/3.25 / NCS 4822 B05G							
	Corrosion class	C3 medium according to ISO/EN 12944-5							
Stator winding	Material	Copper							
	Insulation	Insulation class F							
	Winding protection	3 pcs thermistors							
Rotor winding	Material	Pressure die-cast aluminum							
Balancing method		Half key balancing							
Heating elements	On request	25 W							
Key ways		Closed key-way							
Drain holes		Not included					As standard, open on delivery		
External earthing bolt		As standard							
Enclosure		IP 55							
Cooling method		IC 411							

Increased safety motors with cast iron frame in brief, basic design

Motor size		200	225	250	280	315	355	400	
Stator	Material	Cast iron, at least EN-GJL-200							
	Paint colour shade	Blue, Munsell 8B 4.5/3.25 / NCS 4822 B05G							
	Corrosion class	C3 medium according to ISO/EN 12944-5							
Bearing end shields	Material	Cast iron, at least EN-GJL-200							
	Paint color shade	Blue, Munsell 8B 4.5/3.25 / NCS 4822 B05G							
	Corrosion class	C3 medium according to ISO/EN 12944-5							
Bearings	D-end	2-pole	6312/C3	6313/C3	6315/C3	6316/C3	6316/C3	6316M/C3	6317M/C3
		4-12 -pole	6312/C3	6313/C3	6315/C3	6316/C3	6319/C3	6322/C3	6324/C3
	N-end	2-pole	6310/C3	6312/C3	6313/C3	6316/C3	6316/C3	6316M/C3	6317M/C3
		4-12 -pole	6310/C3	6312/C3	6313/C3	6316/C3	6316/C3	6316/C3	6319/C3
Axially-locked bearings	Inner bearing cover	As standard, locked at D-end							
Bearing seal		Gamma ring				V-ring			
Lubrication		Regreasable bearings				Regreasable bearings			
SPM-nipples		As standard							
Rating plate	Material	Stainless steel							
Terminal box	Frame material	Cast iron, at least EN-GJL-200							
	Cover material	Cast iron, at least EN-GJL-200							
	Cover screws material	Steel 8.8, zinc electroplated and chromated							
Connections	Cable entries	2xM50x1.5			2xM63x1.5		2xM63x1.5	2xØ60/80	2xØ80
	Terminals	6 terminals for connection with cable lugs (not included)							
Fan	Material	Polypropylene. Reinforced with glass fibre.						Polypropylene. Reinforced with glass fibre or aluminum.	
Fan cover	Material	Hot dip galvanized steel							
	Paint color shade	Blue, Munsell 8B 4.5/3.25 / NCS 4822 B05G							
	Corrosion class	C3 medium according to ISO/EN 12944-5							
Stator winding	Material	Copper							
	Insulation	Insulation class F							
	Winding protection	3 pcs thermistors							
Rotor winding	Material	Pressure die-cast aluminum							
Balancing method		Half key balancing							
Heating elements	On request	25 W	60 W			120 W			
Key ways		Closed key way				Open key way			
Drain holes		As standard, open on delivery							
External earthing bolt		As standard							
Enclosure		IP 55							
Cooling method		IC 411							

www.jamcosanat.com

Non-sparking motors Ex nA Totally enclosed squirrel cage three phase low voltage motors, Sizes 63 - 450, 0.12 to 1000 kW



www.abb.com/motors&generators

- > Motors for explosive atmospheres
- >> Non-sparking motors

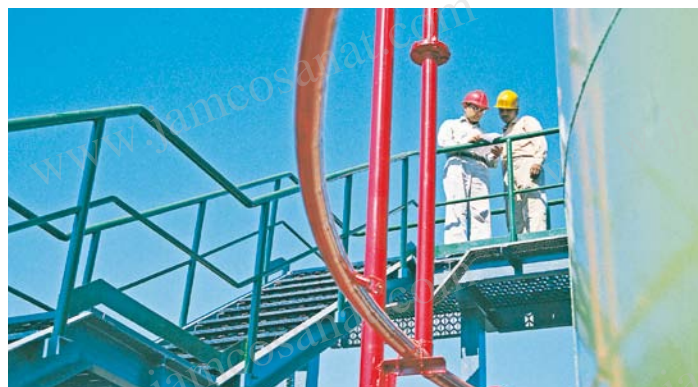

Mechanical design

Drain holes

Non-sparking Ex nA motors in frame sizes 160-450 are fitted with drain holes and plugs as standard. Plugs are of plastic material and are delivered in open position.

Drain holes and plugs are available for frame sizes 80-132 as an option. Please see variant code section.

Type of protection	Frame material	Frame size	Drain holes
Non-sparking	Cast iron	80-132	optional
		160-450	open
Aluminum		63-132	closed

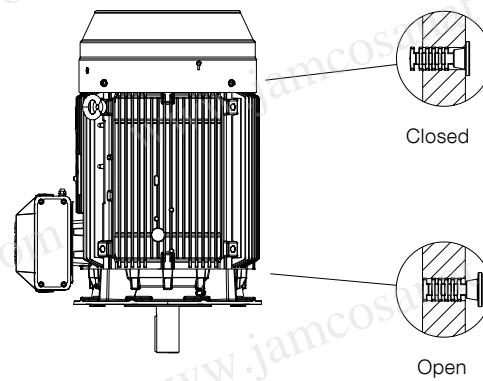
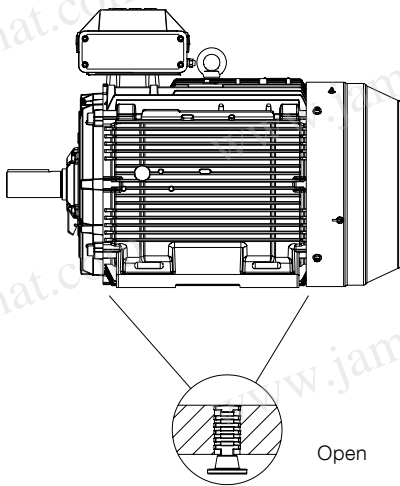

M000178

Terminal box standard delivery, cast iron frame

Terminal boxes are mounted on top of the motor at D-end as standard. The terminal boxes of motor sizes 80-355 can be turned 4x90° and in motor sizes 400 2x180° after delivery. When ordering Ex nA motors in sizes 280-400 with 4x90°, the position of the terminal box has to be defined in the order.

The degree of standard terminal box is IP55 and it complies with the requirements of this enclosure type and effectively prevents all ignition sources such as sparks, excessive overheating etc. The features of the terminal box are : no selfloosening terminals, compliance with creepage distances and clearances specified in standards.

If no ordering information on the cable is given, it is assumed to be p.v.c. -insulated non-armoured and termination parts are supplied according to the table on the following pages.

To enable the supply of suitable terminations for the motor, please state cable type, quantity, size and outer diameter when ordering.

All Ex nA motors are delivered as standard with cable glands or cable sealing end units according to the below table. Different glands can be provided separately as an option. Please see Alternatives section for details.

Note: For 500 V motor information please contact ABB!

Standard delivery 400/690 V (if nothing else is informed)

Motor size	Pole number	Terminal box type	Terminal box opening	45° adapter (variant code)	Threaded holes	Cable gland	Cable sealing end unit (variant code)	Cable outer diameter mm	Single core cross-section mm ² for rated power	Terminal bolt size 6 x
80-90	2-8	25	B	-	1xM25	1xM25	-	Ø10-16	10	M5
100-132	2-8	25	B	-	2xM32	2xM32	-	Ø16-21	10	M5
160-180	2-8	63	B	-	2xM40	2xM40	-	2xØ18-27	35	M6
200-250	2-8	160	B	-	2xM50	2xM50	-	2xØ26-35	70	M10
280	2-8	210	C	-	2xM63	2xM63	-	2xØ32-49	2x150	M12
315SM, ML	2-8	370	D	-	2xM63	2xM63	-	2xØ32-49	2x240	M12
315LKA, LKB	2-4	370	D	-	2xM63	2xM63	-	2xØ32-49	2x240	M12
315LKC	2-4	750	E	E-D (294)	-	-	medium (278)	2xØ48-60	4x240	M12
315 LKA, LKB, LKC	6-8	370	D	-	2xM63	2xM63	-	2xØ32-49	2x240	M12
355 SMA, SMB, SMC	2-4	750	E	E-D (294)	2xM63	2xM63	medium (278)	2xØ48-60	4x240	M12
355 SMC	6	750	E	E-D (294)	2xM63	2xM63	medium (278)	2xØ48-60	4x240	M12
355 SMC	8	370	D	-	2xM63	2xM63	-	2xØ32-49	2x240	M12
355 SMA, SMB	6-8	370	D	-	2xM63	2xM63	-	2xØ32-49	2x240	M12
355 ML, LK	2-4	750	E	E-D (294)	-	-	large (279)	2xØ60-80	4x240	M12
355 ML, LK	6-8	750	E	E-D (294)	-	-	medium (278)	2xØ48-60	4x240	M12
400 L, LK	2-6	750	E	E-D (294)	-	-	large (279)	2xØ60-80	4x240	M12
400 L, LK	8	750	E	E-D (294)	-	-	medium (278)	2xØ48-60	4x240	M12
450	2-4	1200	E	E-2D (295)	-	-	2x large (279)	4xØ60-80	6x240	M12
450 LA, LB, LC, LD	6-8	750	E	E-D (294)	-	-	large (279)	2xØ60-80	4x240	M12

Auxiliary cable entries

80-132	2-8	1xM20	1xM20	1xØ8-14
160-400	2-8	2xM20	2xM20	1xØ8-14

Earthings on motor

	Frame	Terminal box
80-132	M6	M6
160-180	M6	M6
200-250	M8	M8
280-315	M10	2xM10
355-400	M10	2xM10
450	M10	4xM12

Terminal box alternatives, cast iron frame

Optional adapters

There is a broad selection of cable termination accessories available to allow termination of one or several cables. The most common ones are explained below, for other options please contact ABB.

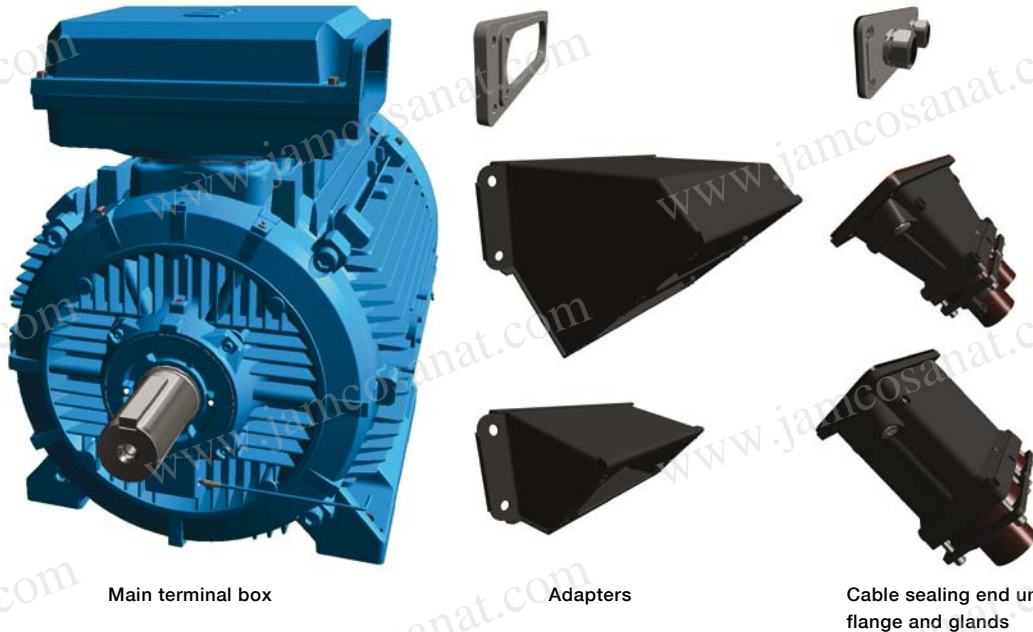

Main terminal box

Adapters

Cable sealing end units, flange and glands

M000443

How to order?

- Check first that the terminal box can allow mounting of the cable and cores (refer to motor type and terminal box type cross reference page 121).
- If very large cables are used might it be necessary to use a larger terminal box than standard. Select the right cable gland(s) or cable sealing end unit(s) depending on outer diameter of the cable(s).
- Select a appropriate adapter and gland(s) and gland plate or cable sealing end unit.
- Note that turning the terminal box to a non standard position might limit the use of some adapters.

Ordering example

Motor	200 kW, 4 pole, 400 V 50 Hz,
Cables	cables needed: 2 pieces, outer diameter 58 mm, single cross section 185mm, cables coming from below
Needed one terminal box for anticondensation heaters (220V) and another for temperature detectors, terminal box material cast iron.	
Motor	M3GP 315 MLA 4, B3
Adapter	D-D (variant code 293)
Cable sealing end unit	Variant code 278
Auxiliaries	Variant codes 451, 380, 567, 568

1. Main terminal box and maximum single core cross section

Larger than standard single core cross section is available as option according to the table below. Also one size larger terminal box can be selected. Please check also the capacity of the cable entry to make sure the cables fit.



Standard terminal box	Size of opening	Max single cross section per phase mm ²	Variant code 019 larger terminal box than standard	Size of opening with larger terminal box that standard Variant code 019	Max single cross section per phase mm ²
25	B	35	-	-	-
63	B	95	-	-	-
160	C	120	-	-	-
210	C	2 x 240	370	D	2 x 300
370	D	2 x 300	750	E	4 x 500
750	E	4 x 500	1200	E	4 x 500
1200	E	4 x 500	NA	NA	NA

The accessories for using the maximum single core cross sections are not included as standard. For this option please use variant code 300 (Increased single core cross section). Each terminal has got limited maximum cable entry size, please request if necessary.

2. Optional adapters

To allow easy termination of cables entering the terminal box from above or below is it recommended to use an angle adapter.

These can also be used to allow mounting of several cable sealing end units or gland plates on the terminal box for termination of more cables than one cable sealing end unit or gland plate can allow.

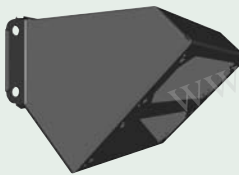
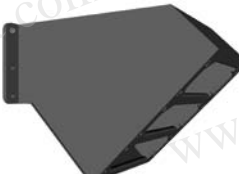
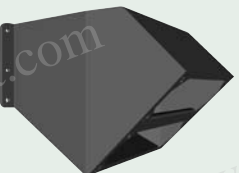
Adapter	Variant code	Opening towards terminal box	Glandplate or opening for cable sealing end unit	Material	Notes
	292 M000430	C	C	Steel	
	293 M000431	D	D	Steel	
	294 M000432	E	D	Steel	Included in std delivery with 750 type terminal box
	295 M000433	E	2 pcs E	Steel	Only possible on terminal box 1200
	296 M000434	E	3 pcs D	Steel	Only possible on terminal box 1200
	444 M000435	E	2 pcs D	Steel	Included in std delivery with 1200 type terminal box

Note: Black painted steel

3. Glandplate, maximum size of glands and material

Glandplates delivered blind or be drilled and tapped to accommodate glands to suit the cable diameter and amount of glands needed.

Standard gland plate material is siluminium, painted steel or stainless steel are available as options.

Size	Maximum size and number of glands, metric		
C	2xM90	3xM50	7xM32
D	4xM90	4xM63	7xM50
E	6xM90	7xM63	9xM50

Related variant codes:

- 729 Cable flanges without holes / Blank gland plates.
- 730 Prepared for NPT glands
- 732 Standard cable gland, Ex d IIB, armoured cable.
- 733 Standard cable gland, Ex d IIB, non-armoured cable.
- 743 Painted steel, blind
- 744 Stainless steel, blind
- 745 Painted steel with brass glands
- 746 Stainless steel with brass glands

4. Cable glands and cable sealing end units

Cable glands

Table below shows the selection of cable gland types and possible cable outer diameter of each size.

Outer diameter, mm			
	Variant code 745	Variant code 737	Variant code 704
	Painted steel flange equipped with brass cable glands	Standard cable gland Ex e with clamping device acc. to EN-Standards	EMC cable gland
Motor sizes 80-450:			
M20	8-14	8-14	8-14
M25	10-16	10-16	10-16
M32	14-21	14-21	14-21
M40	18-27	18-27	18-27
M50	26-35	26-35	26-35
M63	32-49	32-49	32-49
M75	46-60	NA	NA
M90	55-70	NA	NA



For armoured and NPT cable glands please contact ABB.

Cable sealing end unit

As an alternative to flanges and cable glands, cable sealing units can be used. These allow more space for spreading the cores for easy terminating on the terminals.

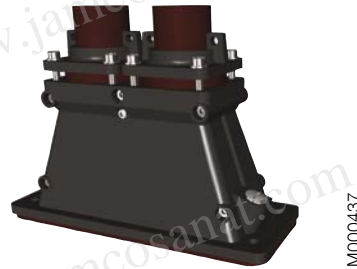
Cable sealing end units have rubber sealed entries for one or two main cables. In addition are there two M20 plugged holes for auxiliary cables.



					Accessories	
Variant code	Opening towards terminal box	Cable outer diameter mm	Cable entry auxiliary cable	Variant code 704; EMC cable gland	Variant code 231; Standard cable gland with clamping device	
 M000436 277	C	1 or 2 pcs (48-60 mm *)	2 pcs M20 plugged holes	Optional	Optional	
 M000437 278	D	1 or 2 pcs (48-60 mm *)	2 pcs M20 plugged holes	Optional	Optional	
 M000438 279	D	1 or 2 pcs (60-80 mm *)	2 pcs M20 plugged holes	Optional	Optional	

*) Depending on how the cable seal inside the cable sealing end unit is used also 40-52mm is available.

5. Auxillary terminal box

It's possible to equip the motors from frame size 160 upwards with one or several auxillary terminal boxes for connection of auxiliaries like heaters or temperature detectors.

The standard auxillary terminal box is made of aluminium and equipped with M20 glands for entry of the connection cables. As an option cast iron terminal box is available.

Connection terminals are spring loaded type for quick and easy connection. These are suitable for up to 2,5mm² wires. Auxillary terminal boxes are equipped with an earthing terminal.

As standard the first auxillary terminal box is located on RHS seen from D-end.

Small, aluminum auxiliary terminal box
(80 x 125 mm, for max. 12 wires)
Earthing size M4



Large, aluminum auxiliary terminal box
(80 x 250 mm, for max. 30 wires)
Earthing size M4



Cast iron auxiliary terminal box
(211 x 188 mm, for max. 30 wires)
Earthing M6



Standard cable entry size M20. Number of entries depends on the terminal box type and number of selected auxiliaries.

Related variant codes:

- 418 Separate terminal box for auxiliaries, standard material (all connections of temperature detectors and heaters will be put in same box)
- 380 Separate terminal box for temperature detectors, standard material
- 568 Separate terminal box for heating elements, standard material
- 569 Separater terminal box for brakes, standard material
- 567 Separate terminal box material: Cast iron

Dimension drawings

Non-sparking motors, cast iron frame

Terminal boxes, standard design with 6 terminals

Motor sizes 80 - 132

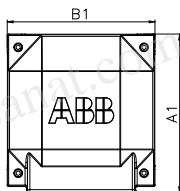

M000368

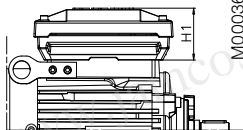

M000368

Motor sizes 160 - 180

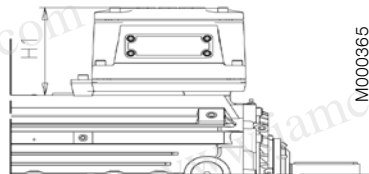

M000365

Motor sizes 200 - 250

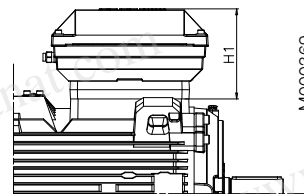

M000369

Motor sizes 280 - 315

Top- and side-mounted
Terminal boxes 210, 370

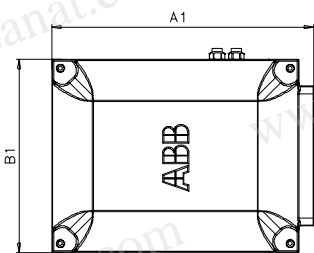

M000205

Motor sizes 355 - 450

Top-mounted
Terminal box 750 + adapter

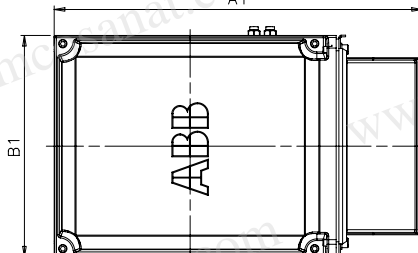
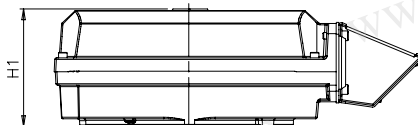

M000206

Side-mounted
Terminal box 750

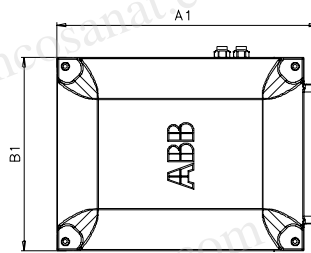

M000205

Motor sizes 450

Top-mounted
Terminal box 1200

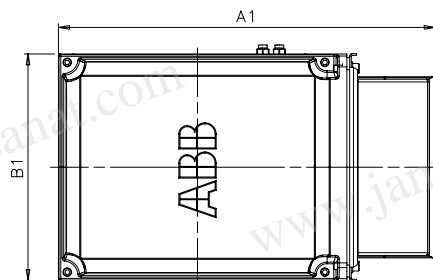

M000331

Motor size	Terminal box	A1	B1	H1
80-132	25	202	188	66
160-180	63	234	234	68
200-250	160	352	319	147
280-400	210	416	306	177
315-370	370	451	347	200
355-450	750 top-mounted	686	413	219
355-450	750 side-mounted	525	413	219
450	1200	1250	578	285
		1195	578	285
		1000	578	285

Terminal box alternatives, aluminum frame

Sizes 63 to 180

The terminal box is made of aluminum alloy and is located on top of the stator. The lower part of the box is integrated with the stator. It is provided with two knockout openings on each side. Sizes 132 SM_ and 160-180 also have a third smaller opening. Cable glands are not included.

Sizes 200 to 280

The terminal box and cover are made of deep drawn steel and mounted on top of the stator. The box is bolted to the stator and is not rotatable. The size of the box is the same for all motors.

In the basic design the terminal box is provided with two

FL 13 flange openings, one on each side. The opening on the right side, seen from the D-end, is supplied with a flange with two holes for M40 cable glands. On delivery the holes are sealed by means of plastic plugs. Cable glands are not supplied. The opening on the other side is provided with a cover flange.

The motors can also be provided with an extra large terminal box, standard for voltage code S and frame size 280. See variant code 019 under the heading "Terminal box". This will increase the dimension HD by 32 mm. The box is supplied with two FL 21 openings. The right opening is provided with a flange with two holes for M63 cable glands. The holes are sealed by means of plastic plugs. Cable glands are not supplied. The opening on the other side is provided with a cover flange. The box can also be provided with an FL 13 opening towards the N-end.

When new motors are manufactured the terminal box can be mounted on the left or the right side. See variant codes 021 and 180 under the heading "Terminal box".

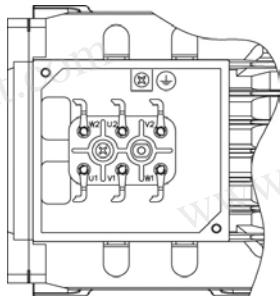

Terminal board for motor size 63

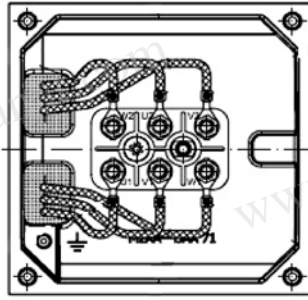

Terminal board for motor sizes 71 to 80

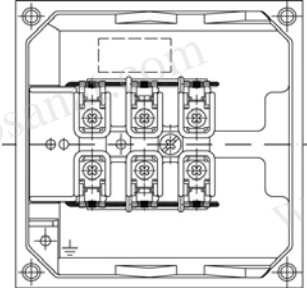

Terminal board for motor sizes 90 to 112

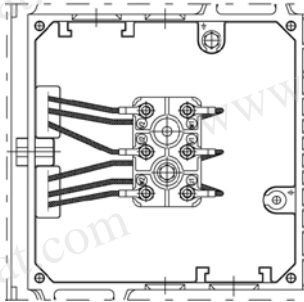

Terminal board for motor size 132

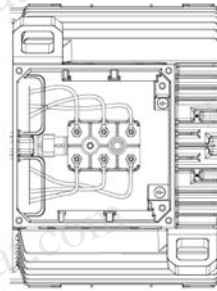

Terminal board for motor sizes 160 to 180

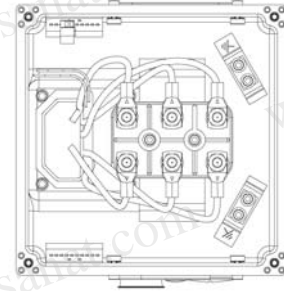

Terminal board for motor sizes 200 to 280

Connections

The terminal block is provided with six terminals for connecting Cu-cable. The terminals are marked in accordance with IEC 60034-8.

Connection openings

Motor size	Opening	Metric cable entry	Method of connection	Terminal bolt size	Maximum connectable Cu-cable area, mm ²
63	Knock-out opening	1 x M16 x 1.5 1 x Pg 11	Cable lug	M4	2.5
71-80	Knock-out opening	2 x (2 x M20)	Cable lug	M4	4
90-112	Knock-out opening	2 x (M25 + M20)	Screw terminal	M4	6
132 ¹⁾	Knock-out opening	2 x (M25 + M20)	Cable lug	M5	10
132 ²⁾	Knock-out opening	2 x (M40 x M32 + M12)	Cable lug	M6	35
160-180	Knock-out opening	2 x (2 x M40 + M16)	Cable lug	M6	35
200-250	2 x FL 13	1 x (2 x M40 + M16)	Cable lug	M10	70
280	2 x FL 21	1 x (2 x M63 + M16)	Cable lug	M10	70

¹⁾ all types except ²⁾

²⁾ SM_

Dimensions for terminal box

Code 019 Larger than standard terminal box

Motor size	Dimensions	Dimensions			
		AD	HB	HD	HE
M3AA 200 ML.		332.5	332.5	603	240
M3AA 225 SM.		353	353	578	260.5
M3AA 250 SM.		376	376	626	283.5

Code 021 Terminal box on left-hand side seen from D end

Code 180 Terminal box on right-hand side seen from D end

Motor size	Dimensions	Dimensions			
		AD	HB	HD	HE
M3AA 200 ML.		332	332	532	239
M3AA 225 SM.		354	354	579	260.5
M3AA 250 SM.		377	377	627	284

Code 467 Lower than standard terminal box without screw terminals and extended rubber connection cable 2 m.

Motor size	Dimensions		
	AD	HB	HD
160		211.5	371.5
180		226.5	406.5
200 ML.	248	248	448
225 SM.	269	269	494
250 SM.	292	292	542
280	292	292	572

Permissible loadings on the shaft end

The following tables give the permissible radial and axial forces in Newton, assuming only radial or axial force is applied. Permissible loads of simultaneous radial and axial forces will be supplied on request.

The bearing life, L_{10} , is calculated according to ISO 281:1990/ Amd 2:2000 standard theory, which also takes the purity of the grease into consideration. An adequate lubrication is a necessary prerequisite for the table below.

The values are based on normal conditions at 50 Hz. At 60 Hz the values must be reduced by 10 %. For two-speed motors, the values must be based on the higher speed.

Motors are foot-mounted IM B3 version with force directed sideways. In some cases the strength of the shaft affects the permissible forces.

If the bearing at the D-end is replaced with a roller bearing (NU- or NJ-), higher radial forces can be handled. Roller bearings are suitable for belt drive applications.

If the radial force is applied between points X_0 and X_{max} , the permissible force F_R can be calculated from the following formula:

$$F_R = F_{X_0} - \frac{X}{E} (F_{X_0} - F_{X_{max}})$$

E = length of shaft extension in basic version

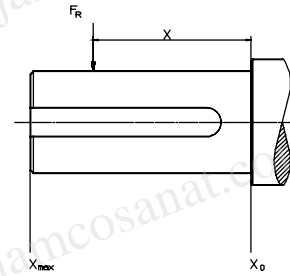

M000145

Cast iron motors, sizes 80 to 132

Permissible radial forces according to L_{10} principle

Non-sparking

Motor size	Poles	Length of shaft extension E (mm)	Ball bearings	
			F_{X_0} (N)	$F_{X_{max}}$ (N)
80	2	40	619	524
	4	40	780	663
	6	40	893	759
	8	40	983	834
90	2	50	561	473
	4	50	803	677
	6	50	919	775
	8	50	1011	853
100	2	60	553	457
	4	60	1050	868
	6	60	1267	1047
	8	60	1395	1153
112	2	60	553	457
	4	60	1050	868
	6	60	1267	1047
	8	60	1394	1152
132	2	80	1354	1112
	4	80	1772	1454
	6	80	2028	1665
	8	80	2234	1833

Cast iron motors, sizes 160 to 450

Permissible radial forces according to L₁₀ principle

Non-sparking motors

Motor size	Poles	Length of shaft extension E (mm)	Ball bearings		Roller bearings	
			40,000 hours		40,000 hours	
			FX ₀ (N)	FX _{max} (N)	FX ₀ (N)	FX _{max} (N)
160	2	110	2500	2100	6400	2200
	4	110	3150	2200	7850	2200
	6	110	3650	2200	8800	2200
	8	110	3900	2100	8750	2100
180	2	110	2900	2400	6950	3500
	4	110	3650	3050	8500	3500
	6	110	4150	3500	9700	3500
	8	110	4500	3050	9900	3050
200 ML₋	2	110	3800	3150	9500	4550
	4	110	4800	3950	11700	4550
	6	110	5500	4550	13200	4550
	8	110	6050	4550	14400	4550
225 SM₋	2	110	4350	3550	11650	4550
	4	140	5450	4400	14300	4550
	6	140	6250	4650	16200	4650
	8	140	6900	4650	17650	4650
250 SM₋	2	140	5350	4100	15400	4100
	4	140	6750	5450	18950	5800
	6	140	7750	5800	21400	5800
	8	140	8550	5800	23350	5800
280 SM₋	2	140	5800	4900	16500	6000
	4	140	7300	6200	20300	9200
	6	140	8400	7000	23000	9200
	8	140	9200	7800	25100	9200
315 SM₋	2	140	5800	4950	16500	6000
	4	170	9000	7450	26600	9600
	6	170	10300	8500	30000	9600
	8	170	11400	9400	32700	9600
315 ML₋	2	140	5850	5050	16700	5850
	4	170	9100	7650	26500	13600
	6	170	10400	8800	29900	13600
	8	170	11500	9700	32600	13600
315 LK₋	2	140	5800	5150	16800	5550
	4	170	9100	7850	26800	13350
	6	170	10450	9050	30300	13350
	8	170	11550	10000	33100	13350
355 SM₋	2	140	5750	5050	16700	7200
	4	210	12000	9950	36900	14000
	6	210	13800	11400	41700	14000
	8	210	15250	12600	45500	14000
355 ML₋	2	140	5750	5100	16800	6750
	4	210	12000	10100	37200	13600
	6	210	13900	11600	42100	13600
	8	210	15300	12900	45900	13600
355 LK₋	2	140	5650	5150	17000	6750
	4	210	11850	10200	37300	13000
	6	210	13700	11900	42000	13000
	8	210	15200	13000	46000	13000
400 LK₋	2	170	4400	3900	19350	9050
	4	210	12150	10550	43300	11500
	6	210	13850	11500	48800	11500
	8	210	15350	11500	53200	11500
400 L₋	2	170	4400	3900	19350	9050
	4	210	12150	10550	43300	16000
	6	210	13850	12000	48800	16000
	8	210	15350	13350	53200	16000
450 L₋	2	170	3500	3300	19000	7500
	4	210	13000	11600	50000	25000
	6	210	14000	13000	56000	24000
	8	210	16500	14600	62000	23000

Permissible axial forces according to L₁₀ principle

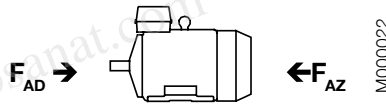

Cast iron motors, motor sizes 80 - 450

Mounting arrangement IM B3

Motor size	20,000 hours								40,000 hours							
	2-pole		4-pole		6-pole		8-pole		2-pole		4-pole		6-pole		8-pole	
	F _{AD} N	F _{AZ} N	F _{AD} N	F _{AZ} N	F _{AD} N	F _{AZ} N	F _{AD} N	F _{AZ} N	F _{AD} N	F _{AZ} N	F _{AD} N	F _{AZ} N	F _{AD} N	F _{AZ} N	F _{AD} N	F _{AZ} N
80	820	460	1010	650	1180	820	1)	1)	1)	1)	1)	1)	1)	1)	1)	1)
90	900	380	1110	590	1260	740	1)	1)	1)	1)	1)	1)	1)	1)	1)	1)
100	1330	440	1620	730	1820	940	1)	1)	1)	1)	1)	1)	1)	1)	1)	1)
112	1330	440	1610	720	1820	930	1)	1)	1)	1)	1)	1)	1)	1)	1)	1)
132 S_	1880	850	2330	1290	2650	1610	1)	1)	1)	1)	1)	1)	1)	1)	1)	1)
160	2820	1910	3560	2650	4150	3240	4630	3720	2220	1310	2780	1870	3230	2320	3590	2680
180	3190	2280	4080	3170	4720	3810	5260	4350	2500	1590	3160	2250	3640	2740	4060	3150
200	4230	2960	5380	4120	6270	5000	6960	5700	3320	2060	4184	2920	4850	3590	5380	4120
225	4740	3270	6070	4600	7020	5550	7830	6360	3720	2250	4720	3250	5430	3970	6050	4590
250	6470	3370	8100	5000	9250	6150	10220	7130	5220	2130	6440	3340	7300	4210	8040	4950
280 SM_	4200	6250	6000	8000	5250	11250	8300	10300	2900	4900	4250	6250	5150	7150	5950	7950
315 SM_	4180	6200	7400	9400	8900	10900	10000	12000	2850	4850	5250	7250	6350	8350	7200	9000
315 ML_	4050	6050	7250	9250	8650	10650	9500	11900	2750	4750	5100	7100	6100	8100	6900	8800
315 LK_	4000	5950	7100	9150	8500	10500	9750	11750	2650	4650	5000	7000	5950	7950	6900	8900
355 SM_	3050	6850	8600	12400	10550	14350	12200	16000	1750	5550	5900	9700	7300	11100	8550	12350
355 ML_	2900	6700	8350	12150	10100	13900	12000	15800	1600	5400	5650	9450	6900	10700	7300	11000
355 LK_	2850	6650	8200	12000	9900	13700	11450	15250	1550	5350	5450	9250	6700	10500	7800	11600
400 LK_	2150	7150	7100	13100	8850	14850	10450	16450	1)	5800	4300	10300	5500	11500	6750	12750
400 L_	2150	7150	7100	13100	8850	14850	10450	16450	1)	5800	4300	10300	5500	11500	6750	12750
450 L_	1800	6800	7600	13500	9000	15000	10800	16800	1)	5500	4500	10500	5600	11500	7000	12900

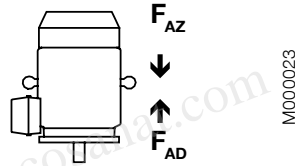

Mounting arrangement IM V1

Motor size	20,000 hours								40,000 hours							
	2-pole		4-pole		6-pole		8-pole		2-pole		4-pole		6-pole		8-pole	
	F _{AD} N	F _{AZ} N	F _{AD} N	F _{AZ} N	F _{AD} N	F _{AZ} N	F _{AD} N	F _{AZ} N	F _{AD} N	F _{AZ} N	F _{AD} N	F _{AZ} N	F _{AD} N	F _{AZ} N	F _{AD} N	F _{AZ} N
80	850	440	1060	650	1220	800	1)	1)	1)	1)	1)	1)	1)	1)	1)	1)
90	940	350	1150	550	1320	690	1)	1)	1)	1)	1)	1)	1)	1)	1)	1)
100	1400	390	1710	650	1940	860	1)	1)	1)	1)	1)	1)	1)	1)	1)	1)
112	1410	380	1730	640	1950	850	1)	1)	1)	1)	1)	1)	1)	1)	1)	1)
132 S_	2010	730	2520	1150	2890	1440	1)	1)	1)	1)	1)	1)	1)	1)	1)	1)
160	3070	1660	4060	2320	4530	2890	4950	3350	2470	1060	3280	1530	3600	1970	3910	2310
180	3580	1980	4650	2680	5430	3340	5970	3890	2880	1280	3730	1760	4360	2260	4760	2680
200	4790	2480	6240	3550	7070	4300	7850	5020	3870	1560	5030	2340	5650	2890	6260	3430
225	5540	2670	7000	3860	8130	4700	8860	5480	4510	1650	5640	2500	6540	3100	7080	3700
250	7390	2640	9200	4080	10670	5000	11660	5970	6135	1380	7530	2410	8710	3040	9470	3780
280 SM_	5550	5150	7600	6550	9150	7500	10200	9000	4200	3800	5800	4750	7000	5350	7850	6700
315 SM_	5950	4600	9750	7500	11600	8300	13350	9900	4600	3300	7550	5300	9050	5750	10450	7000
315 ML_	6650	4300	10500	7050	12900	7800	13400	8300	5300	2900	8300	4900	10350	5250	11600	5400
315 LK_	7100	3350	11100	5850	13700	6100	14900	8300	5750	2450	8900	3700	11100	3550	12100	5450
355 SM_	6350	4250	13250	8600	15650	9580	17350	12500	4950	2900	10450	5850	12350	6270	13600	8900
355 ML_	7100	3700	14600	7950	18050	8600	21100	11650	5750	2350	11850	5150	14700	5300	17000	7600
355 LK_	7500	3150	15650	6600	19100	7050	21200	8700	6150	1800	12850	3800	15800	3750	17500	5000
400 LK_	8650	2150	16050	6400	18450	6750	20100	8350	7220	1)	13150	3400	15100	3400	16450	4700
400 L_	8650	2150	16050	6400	18450	6750	20100	8350	7220	1)	13150	3400	15100	3400	16450	4700
450 L_	11500	1)	20000	4400	26000	3700	27800	5500	1)	1)	17700	1200	22200	1)	23700	1350

¹⁾ On request

Aluminum motors

Permissible radial forces according to L_{10} principle

Motors sizes 63 to 132

Motor size	No. of poles	Length of shaft extension E (mm)	Ball bearings							
			Basic design with deep groove ball bearings				Alternative design with 63-series bearings			
			25,000 hours		40,000 hours		25,000 hours		40,000 hours	
F_{X_0} (N)	$F_{X_{max}}$ (N)	F_{X_0} (N)	$F_{X_{max}}$ (N)	F_{X_0} (N)	$F_{X_{max}}$ (N)	F_{X_0} (N)	$F_{X_{max}}$ (N)			
63	2-8	23	490	400	490	400				
71	2-8	30	680	570	680	570				
80	2-8	40	930	750	930	750				
90	2-8	50	1010	810	1010	810				
100	2-8	60	2280	1800	2280	1800				
112 M	2	60	1800	1420	1620	1280	2160	1700	2160	1700
	4	60	1790	1410	1590	1250	2160	1700	2160	1700
	6	60	1910	1510	1700	1340	2160	1700	2160	1700
	8	60	1940	1530	1720	1360	2160	1700	2160	1700
112 MB	2	60	1820	1470	1640	1330	2100	1700	2100	1700
	4	60	1770	1430	1560	1260	2100	1700	2100	1700
	6	60	1880	1520	1650	1340	2100	1700	2100	1700
	8	60	1930	1560	1690	1370	1700	2100	1700	2100
132 SA	2	80	3020	2360	2740	2140	4070	3180	3670	2870
132 SB	2	80	3020	2360	2730	2130	4060	3170	3670	2870
132 SC	2	80	3030	2430	2750	2200	3990	3200	3690	2960
132 S	4	80	3120	2440	2790	2180	4090	3200	3830	2990
132 M	4	80	3080	2410	2750	2150	4100	3200	3780	2950
132 MB	4	80	3050	2440	2710	2170	3990	3200	3740	3000
132 S	6	80	3280	2560	2910	2270	4100	3200	3990	3120
132 MA	6	80	3240	2530	2880	2250	4100	3200	3970	3100
132 MB	6	80	3200	2500	2840	2220	4100	3200	3930	3070
132 MC	6	80	3010	2510	2660	2220	3840	3200	3700	3090
132 S	8	80	3370	2630	2980	2330	4100	3200	4100	3200
132 M	8	80	3310	2590	2940	2300	4100	3200	4060	3170
132 MB	8	80	3280	2630	2910	2330	3990	3200	3990	3200

Motors sizes 160 to 280

Motor size	No. of poles	Length of shaft extension E (mm)	Ball bearings				Roller bearings			
			Basic design with deep groove ball bearings				Alternative design with roller bearings			
			25,000 hours		40,000 hours		25,000 hours		40,000 hours	
F_{X_0} (N)	$F_{X_{max}}$ (N)	F_{X_0} (N)	$F_{X_{max}}$ (N)	F_{X_0} (N)	$F_{X_{max}}$ (N)	F_{X_0} (N)	$F_{X_{max}}$ (N)			
160	2	110	4760	3860	4100	3320	6580	4300	5620	4300
	4	110	5180	4200	4380	3545	7340	4300	6180	4300
	6	110	5160	4180	4360	3540	7780	4300	6500	4300
	8	110	6280	4300	5320	4300	8860	4300	7440	4300
180	2	110	6060	4960	5280 ¹⁾	4305 ¹⁾	7600	5500	6560	5500
	4	110	4800	3940	4020	3300	7280	5500	6140	5500
	6	110	6280	5140	5280	4380	8680	5500	7280	5500
	8	110	6960	5500	5880	4800	9440	5500	7920	5500
200	2	110	7800	6500	6760 ²⁾	5640 ²⁾	10360	8640	8880	7400
	4	110	8400	7020	7180	5980	11560	9550	9800	8180
	6	110	8960	7480	7600	6340	12480	9550	10520	8780
	8	110	10480	8740	8940	7400	14100	9550	11920	9550
225	2	110	8520	7180	7360 ³⁾	6200 ³⁾	12320	10380	10560	8900
	4	140	8380	6780	7200	5820	13380	10250	11320	9160
	6	140	10960	8860	9360	7560	15860	10250	13420	10250
	8	140	12100	9780	10340	8360	17220	10250	14580	10250
250	2	140	10480 ⁴⁾	8500 ⁴⁾	9080 ⁴⁾	7360 ⁴⁾	16220	10900	13960	10900
	4	140	10840	8780	9380	7600	18020	13800	15320	13800
	6	140	12600	10220	10700	8680	20240	13800	17140	13800
	8	140	14660	11880	12540	10160	22680	13800	19220	13800
280	2	140	6780	5500	5680	4600	16280	13200	14000	11360
	4	140	8060	6540	6640	5380	19480	15780	16540	13400
	6	140	8980	7280	7360	5960	21920	17760	18580	15060
	8	140	9180	7460	7460	6060	22240	18020	18860	15300

¹⁾ The maximum lifetime of the grease is 38 000 h

²⁾ The maximum lifetime of the grease is 27 000 h

³⁾ The maximum lifetime of the grease is 23 000 h

⁴⁾ The maximum lifetime of the grease is 16 000 h

Permissible axial forces according to L_{10} principle

The following tables give the permissible axial forces in Newton, assuming zero radial force. The values are based on normal conditions at 50 Hz with standard bearings and calculated bearing lives of 20,000 and 40,000 hours.

At 60 Hz the values are to be reduced by 10%.

For two-speed motors, the values are to be based on the higher speed. The permissible loads of simultaneous radial and axial forces will be supplied on request.

Given axial forces F_{AD} , assumes D-bearing locked by means of locking ring. Without locking ring the F_{AD} forces should be reduced to 70% of list value.

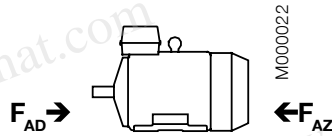

Aluminum motors, motor sizes 63 - 280

Mounting arrangement IM B3

Motor size	20,000 hours								40,000 hours							
	2-pole		4-pole		6-pole		8-pole		2-pole		4-pole		6-pole		8-pole	
	F_{AD}	F_{AZ}	F_{AD}	F_{AZ}	F_{AD}	F_{AZ}	F_{AD}	F_{AZ}	F_{AD}	F_{AZ}	F_{AD}	F_{AZ}	F_{AD}	F_{AZ}	F_{AD}	F_{AZ}
63	480	125	565	165	580	190	590	195	420	105	470	115	490	145	590	205
71	625	325	780	480	890	590	985	685	515	215	630	330	710	410	780	480
80	810	470	1015	675	1170	830	1300	960	650	315	810	470	925	595	1015	675
90	885	485	1170	650	1270	870	1410	1010	720	320	945	425	1005	605	1110	710
100	1620	1120	2065	1565	2390	1890	2660	2160	1280	780	1615	1115	1860	1360	2065	1565
112 M	-	-	-	-	-	-	2655	2155	-	-	-	-	-	-	2060	1560
112 MB	1615	1115	2060	1560	2385	1885	2655	2155	1275	775	1610	1110	1860	1360	2060	1560
132 M	-	-	2245	1645	-	-	2875	2270	-	-	1760	1160	-	-	2240	1640
132 MA	-	-	2245	1645	2595	1995	-	-	-	-	1760	1160	2025	1425	-	-
132 MC	-	-	-	-	2580	1980	-	-	-	-	-	-	2010	1410	-	-
132 MBA	-	-	2235	1635	-	-	-	-	-	-	1750	1150	-	-	-	-
132 S	-	-	-	-	2600	2000	2885	2285	-	-	-	-	2030	1435	2245	1645
132 SA	-	-	-	-	-	-	-	-	-	-	-	-	-	-	-	-
132 SB	1770	1170	-	-	-	-	-	-	1400	800	-	-	-	-	-	-
132 SBB	1760	1160	-	-	-	-	-	-	1395	795	-	-	-	-	-	-
132 SC	1760	1160	-	-	-	-	-	-	1395	795	-	-	-	-	-	-
132 SMA	-	-	-	-	-	-	-	-	-	-	-	-	-	-	-	-
132 SMB	2220	1620	2840	2240	-	-	-	-	1740	1140	2205	1605	-	-	-	-
132 SMC	2220	1620	-	-	-	-	-	-	1740	1140	-	-	-	-	-	-
132 SMD	-	-	2830	2200	-	-	-	-	-	-	2230	1595	-	-	-	-
132 SME	2210	1610	-	-	-	-	-	-	1730	1130	-	-	-	-	-	-
160	4160	4160	4740	4740	4840	4840	5980	5980	3425	3425	3920	3920	4000	4000	4920	4920
180	5480	5480	4360	4360	5980	5980	6000	6620	4600 ¹⁾	4600 ¹⁾	3540	3540	4940	4940	5460	5460
200	5000	6880	5000	7660	5000	8300	5000	9880	5000 ²⁾	5700 ²⁾	5000	6340	5000	6880	5000	8160
225	5000	7380	5000	7600	5000	10140	5000	11420	5000 ³⁾	6120 ³⁾	5000	6220	5000	8420	5000	9460
250	6000 ⁴⁾	9020 ⁴⁾	6000	9800	6000	11520	6000	13700	6000 ⁴⁾	7500 ⁴⁾	6000	8040	6000	9520	6000	11380
280	5260	5260	6500	6500	7500	7500	7740	7740	4220	4220	5160	5160	6040	6040	6180	6180

¹⁾ The maximum lifetime of the grease is 38 000 h

²⁾ The maximum lifetime of the grease is 27 000 h

³⁾ The maximum lifetime of the grease is 23 000 h

⁴⁾ The maximum lifetime of the grease is 16 000 h

Permissible axial forces according to L₁₀ principle

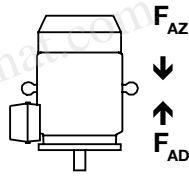

M000023

Aluminum motors, motor sizes 63 - 280

Mounting arrangement IM B5

Motor size	20,000 hours								40,000 hours							
	2-pole		4-pole		6-pole		8-pole		2-pole		4-pole		6-pole		8-pole	
	F _{AD} N	F _{AZ} N	F _{AD} N	F _{AZ} N	F _{AD} N	F _{AZ} N	F _{AD} N	F _{AZ} N	F _{AD} N	F _{AZ} N	F _{AD} N	F _{AZ} N	F _{AD} N	F _{AZ} N	F _{AD} N	F _{AZ} N
63	495	115	585	155	600	180	-	-	440	95	490	105	550	115	-	-
71	640	315	800	470	925	570	1020	665	530	200	650	320	745	390	815	455
80	845	450	1075	640	1225	795	1350	925	690	290	865	430	980	550	1070	645
90	945	450	1245	600	1360	815	1485	960	775	280	1020	375	1095	550	1185	660
100	1710	1060	2180	1485	2510	1815	2780	2080	1370	715	1735	1035	1980	1285	2185	1485
112 M	-	-	-	-	-	-	2790	2070	-	-	-	-	-	-	2195	1475
112 MB	1725	1040	2210	1460	2540	1785	2810	2055	1385	700	1110	1010	2010	1260	2210	1460
132 M	-	-	2460	1505	-	-	3130	2115	-	-	1970	1015	-	-	2490	1470
132 MA	-	-	2460	1505	2815	1850	-	-	-	-	1970	1015	2245	1280	-	-
132 MC	-	-	-	-	2885	1780	-	-	-	-	-	-	2315	1210	-	-
132 MBA	-	-	2495	1465	-	-	-	-	-	-	2010	980	-	-	-	-
132 S	-	-	-	-	2780	1885	3100	2145	-	-	-	-	2210	1315	2460	1505
132 SA	-	-	-	-	-	-	-	-	-	-	-	-	-	-	-	-
132 SB	1910	1075	-	-	-	-	-	-	1540	705	-	-	-	-	-	-
132 SBB	1950	1050	-	-	-	-	-	-	1580	670	-	-	-	-	-	-
132 SC	1945	1045	-	-	-	-	-	-	1575	670	-	-	-	-	-	-
132 SMA	-	-	-	-	-	-	-	-	-	-	-	-	-	-	-	-
132 SMB	2435	1480	3150	2035	-	-	-	-	1950	995	2515	1400	-	-	-	-
132 SMC	2445	1470	-	-	-	-	-	-	1960	985	-	-	-	-	-	-
132 SMD	-	-	3195	1995	-	-	-	-	-	-	2560	1355	-	-	-	-
132 SME	2490	1425	-	-	-	-	-	-	2005	940	-	-	-	-	-	-
160	4560	3810	5260	4310	5400	4420	6560	5580	3860	3110	4440	3490	4540	3560	5460	4480
180	5920	5115	5080	3860	6000	5445	6000	6120	5060 ¹⁾	4255 ¹⁾	4240	3020	5600	4385	6000	4900
200	5000	6350	5000	6950	5000	7505	5000	9215	5000 ²⁾	5230 ²⁾	5000	5650	5000	6025	5000	7435
225	5000	6770	5000	6795	5000	9270	5000	10595	5000 ³⁾	5490 ³⁾	5000	5475	5000	7490	5000	8535
250	6000 ⁴⁾	8335 ⁴⁾	6000	8820	6000	10275	6000	12645	6000 ⁴⁾	6755 ⁴⁾	6000	7120	6000	8235	6000	10205
280	6400	4400	7920	5400	8500	6180	8500	6435	5420	3420	6640	4120	7840	4640	7980	4775

¹⁾ The maximum lifetime of the grease is 38 000 h.

²⁾ The maximum lifetime of the grease is 27 000 h.

³⁾ The maximum lifetime of the grease is 23 000 h.

⁴⁾ The maximum lifetime of the grease is 16 000 h.

Rating plates

The rating plates are in table form giving values for speed, current and power factor for cast iron motors: 400V-415V-690V as standard. For aluminum motors there are one or 2 voltages in use ; 230V-400V depending on the frame size. Other voltage and frequency combinations are possible and can be ordered with variant codes 002 or 209. Please see Variant code section.

The following information will be shown on the motor rating plate according to IEC 60034-30:2008:

- Lowest nominal efficiency at 100%, 75% and 50% rated load
- Efficiency level
- Year of manufacture
- Type of protection
- Apparatus group
- Temperature class
- Identification number of the certification body
- Certificate number : for cast iron motors both ATEX and IECEx are stamped on the rating plate as standard. For aluminum motors self certification.

M3GP 80-450

ABB Oy, Motors Vaasa, Finland						
CE 0081 IE2		Ex II 2D				
3 ~ Motor M3GP 225SMC 4 IMB3/IM1001						
Ex tD A21 T125						
414141-46		2010		No. 3GF1000006		
		Ins.cl. F		IP 65		
V	Hz	kW	r/min	A	cos φ	Duty
690 Y	50	45	1477	45	0.88	S1
400 D	50	45	1477	78	0.88	S1
415 D	50	45	1479	77	0.86	S1
IE2 - 94.1% (100%) - 94.6% (75%) - 94.4% (50%)						
Prod. code 3GGP222230-ADG453						
LCIE 06 ATEX 6089 / IECEx LCI 07.0001						
		Nmax		r/min		
6313/C3		6312/C3		405 kg		
		ABB		IEC 60034-1		

M000741

M3AAN 63-80

Asea Brown Boveri, S.A. C/ Illa de Buda, 55. 08192 Sant Quirze del Vallès (Barcelona), Spain						
IE2		Ex II 3G CE				
3~Motor M3AAN 80 C 2 IM3001 Ex nA II T3						
3GAA081313-BSE		No. 3GE102208P4236		Cl. F IP 55		
6204-2Z/C3		6203-2Z/C3		2010 11 kg		
V	Hz	r/min	kW	A	Cos φ	
230 D	50	2880	1,1	3,9	0,81	
400 Y	50	2880	1,1	2,3	0,81	
IE2-82,1(100%)-82,0(75%)-79,2(50%)						IEC 60034-1

M000705

M3AAN 90-132

Asea Brown Boveri, S.A. IE2 CE						
C/ Illa de Buda, 55. 08192 Sant Quirze del Vallès (Barcelona), Spain						
3~ Motor M3AAN 112 MB 2 CL. F IP 55 IEC60034-1						
3GAA111312-BDE		Nº 3GE101711P2312				
V	Hz	r/min	kW	A	Cos φ	
400 D	50	2885	4,0	7,6	0,88	
IE2-86,1(100%)-87,0(75%)-88,0(50%)						
Ex II 3G		2010		30 kg		
6306-2Z/C3		6205-2Z/C3				
Ex nA II T3						

M000706

Ordering information

Sample order

When placing an order, please state the following minimum data in the order, as in example.

The product code of the motor is composed in accordance with the following example.

Motor type	M3GP 160 MLA
Pole number	2
Mounting arrangement (IM code)	IM B3 (IM 1001)
Rated output	11 kW
Product code	3GGP161410-ADH
Variant codes if needed	

Motor size

A	B	C	D.E.F.	G														
M3GP 160 MLA 3GGP 161 410 - A D H 002 etc.																		
<table border="1" style="margin: auto;"> <tr> <td style="width: 15px; text-align: center;">1</td> <td style="width: 15px; text-align: center;">2</td> <td style="width: 15px; text-align: center;">3</td> <td style="width: 15px; text-align: center;">4</td> <td style="width: 15px; text-align: center;">5</td> <td style="width: 15px; text-align: center;">6</td> <td style="width: 15px; text-align: center;">7</td> <td style="width: 15px; text-align: center;">8</td> <td style="width: 15px; text-align: center;">9</td> <td style="width: 15px; text-align: center;">10</td> <td style="width: 15px; text-align: center;">11</td> <td style="width: 15px; text-align: center;">12</td> <td style="width: 15px; text-align: center;">13</td> <td style="width: 15px; text-align: center;">14</td> </tr> </table>					1	2	3	4	5	6	7	8	9	10	11	12	13	14
1	2	3	4	5	6	7	8	9	10	11	12	13	14					
A Motor type		C Product code	E Voltage and frequency code	G Variant codes														
B Motor size		D Mounting arrangement code	F Generation code															

Explanation of the product code:

Positions 1 to 4

3GGP = Totally enclosed fan cooled squirrel cage motor with cast iron frame, non-sparking

3GAA = Totally enclosed fan cooled squirrel cage motor with aluminum frame, non-sparking

Positions 5 and 6

IEC-frame

06 = 63	20 = 200
07 = 71	22 = 225
08 = 80	25 = 250
09 = 90	28 = 280
10 = 100	31 = 315
11 = 112	35 = 355
13 = 132	40 = 400
16 = 160	45 = 450
18 = 180	

Position 7

Speed (Pole pairs)

1 = 2 poles
2 = 4 poles
3 = 6 poles
4 = 8 poles
5 = 10 poles

Position 8 to 10

Serial number

Position 11

- (dash)

Position 12

Mounting arrangement

A = Foot-mounted, top-mounted terminal box

R = Foot-mounted, terminal box RHS seen from D-end

L = Foot-mounted, terminal box LHS seen from D-end

B = Flange-mounted, large flange

C = Flange-mounted, small flange (sizes 71 to 112)

H = Foot- and flange-mounted, terminal box top-mounted

J = Foot- and flange-mounted, small flange with tapped holes

S = Foot- and flange-mounted, terminal box RHS seen from D-end

T = Foot- and flange-mounted, terminal box LHS seen from D-end

V = Flange-mounted, special flange

F = Foot- and flange-mounted. Special flange

Position 13

Voltage and frequency

Single-speed motors

B 380 VΔ 50 Hz

D 400 VΔ, 415 VΔ, 690 VY 50 Hz

E 500 VΔ 50 Hz

F 500 VY 50 Hz

S 230 VΔ, 400 VY, 415 VY 50 Hz

T 660 VΔ 50 Hz

U 690 VΔ 50 Hz

X Other rated voltage, connection or frequency, 690 V maximum

Position 14

Generation code

G, H...

The product code must be, if needed, followed by variant codes.

Non-sparking premium efficiency cast iron motors Ex nA

Technical data for totally enclosed squirrel cage three phase motors

IE3

IP 55 - IC 411 - Insulation class F, temperature rise class B
IE3 efficiency class according to IEC 60034-30; 2008



Output kW	Motor type	Product code	Speed r/min	Efficiency IEC 60034-2-1; 2007			Power factor cos φ	Current		Torque			Moment of inertia J = 1/4 GD ² kgm ²	Weight kg	Sound pressure level L _{PA} dB		
				Full load 100%	3/4 load 75%	1/2 load 50%		I _N A	I _s A	T _N Nm	T _I Nm	T _b Nm					
3000 r/min = 2-poles			400 V 50 Hz			GENELEC-design											
30	M4GP	200 MLE	3GGP	201 450-••J	2957	94.1	94.3	93.7	0.87	52.8	7.7	96.8	2.9	3.3	0.22	310	75
37	M4GP	200 MLF	3GGP	201 460-••J	2958	94.6	94.8	94.3	0.86	65.6	8.3	119	3.2	3.5	0.22	310	75
45	M4GP	225 SME	3GGP	221 250-••J	2970	95.2	95.2	94.6	0.88	77.5	8.0	144	3.0	3.4	0.34	406	76
55	M4GP	250 SMD	3GGP	251 240-••J	2977	95.5	95.7	95.2	0.91	91.3	8.1	176	2.6	2.7	0.68	493	75
75	M4GP	280 SMB	3GGP	281 220-••K	2979	95.5	95.4	94.6	0.87	130	7.3	240	2.1	2.9	0.9	665	77
90	M4GP	280 SMC	3GGP	281 230-••K	2981	95.7	95.6	94.8	0.88	154	8.0	288	2.5	3.1	1.15	725	77
110	M4GP	315 SMB	3GGP	311 220-••K	2982	95.9	95.7	95.0	0.87	190	6.7	352	1.9	2.6	1.4	940	77
132	M4GP	315 SMC	3GGP	311 230-••K	2984	95.9	95.9	95.3	0.88	225	7.9	422	2.4	3.0	1.7	1025	77
160	M4GP	315 MLA	3GGP	311 410-••K	2982	96.1	96.1	95.8	0.90	267	7.3	512	2.2	2.7	2.1	1190	77
200	M4GP	315 MLB	3GGP	311 420-••K	2982	96.2	96.2	96.0	0.90	333	6.8	640	1.9	2.6	2.2	1220	77
200	¹⁾ M4GP	355 SMA	3GGP	351 210-••K	2984	96.2	96.1	95.5	0.89	337	7.6	640	2.0	3.1	3.0	1600	83
250	M4GP	315 LKB	3GGP	311 820-••K	2981	96.3	96.3	96.2	0.91	411	7.9	800	2.5	2.7	2.9	1540	77
250	¹⁾ M4GP	355 SMB	3GGP	351 220-••K	2983	96.3	96.3	95.9	0.90	416	7.6	800	2.2	3.0	3.4	1680	83
315	¹⁾ M4GP	355 SMC	3GGP	351 230-••K	2984	96.4	96.4	95.9	0.89	529	7.8	1008	2.3	2.8	3.6	1750	83
355	¹⁾ M4GP	355 MLA	3GGP	351 410-••K	2982	96.5	96.5	96.3	0.90	589	7.5	1136	2.3	2.6	4.1	2000	83
1500 r/min = 4-poles			400 V 50 Hz			High-output design											
30	M4GP	200 MLE	3GGP	202 450-••J	1478	94.2	94.6	94.5	0.86	53.4	7.8	193	3.2	2.9	0.37	316	61
37	M4GP	225 SME	3GGP	222 250-••J	1482	94.6	95.0	94.8	0.88	64.1	7.6	238	2.9	3.3	0.55	410	67
45	M4GP	225 SMF	3GGP	222 260-••J	1479	94.8	95.2	95.0	0.87	78.7	8.0	290	3.2	3.4	0.59	416	67
55	M4GP	250 SMC	3GGP	252 230-••J	1483	95.3	95.4	95.0	0.86	96.8	7.3	354	2.7	3.4	0.98	495	66
75	M4GP	280 SMB	3GGP	282 220-••K	1486	95.7	95.8	95.3	0.85	133	7.4	481	2.5	2.8	1.5	665	66
90	M4GP	280 SMC	3GGP	282 230-••K	1487	95.9	96.0	95.5	0.85	159	7.9	577	2.9	3.0	1.85	725	66
110	M4GP	315 SMC	3GGP	312 230-••K	1490	96.3	96.3	95.7	0.85	193	7.8	704	2.4	3.1	2.9	1000	68
132	M4GP	315 SMD	3GGP	312 240-••K	1490	96.4	96.4	95.9	0.85	232	7.9	845	2.6	3.2	3.2	1065	68
160	M4GP	315 MLB	3GGP	312 420-••K	1489	96.4	96.4	96.1	0.86	278	7.9	1026	2.7	3.0	3.9	1220	68
200	M4GP	315 LKB	3GGP	312 820-••K	1490	96.5	96.5	96.3	0.87	343	7.6	1281	2.5	2.9	5	1520	74
200	M4GP	355 SMA	3GGP	352 210-••K	1490	96.5	96.5	96.3	0.87	343	7.3	1281	2.1	2.7	5.9	1610	74
250	M4GP	315 LKC	3GGP	312 830-••K	1491	96.6	96.6	96.4	0.87	429	7.8	1601	2.3	3.0	5.5	1600	74
250	M4GP	355 SMB	3GGP	352 220-••K	1491	96.6	96.6	96.3	0.87	429	7.8	1601	2.5	2.9	6.9	1780	74
315	M4GP	355 SMC	3GGP	352 230-••K	1491	96.7	96.7	96.3	0.85	553	7.4	2017	2.8	2.9	7.2	1820	74
355	M4GP	355 MLA	3GGP	352 410-••K	1491	96.7	96.7	96.4	0.86	616	7.9	2273	2.7	2.9	8.4	2140	74

¹⁾ 3dB(A) sound pressure level reduction with unidirectional fan construction. Direction of rotation must be stated when ordering, see variant codes 044 and 045

The two bullets in the product code indicate choice of mounting arrangements, voltage and frequency code (see ordering information page).

I_s / I_N = Starting current
T_I / T_N = Locked rotor torque
T_b / T_N = Pull-out torque

Efficiency values are given according to IEC 60034-2-1; 2007. Please note that the values are not comparable without knowing the testing method. ABB has calculated the efficiency values according to indirect method, stray load losses (additional losses) determined from measuring.

Non-sparking premium efficiency cast iron motors Ex nA

Technical data for totally enclosed squirrel cage three phase motors

IE3

IP 55 - IC 411 - Insulation class F, temperature rise class B
IE3 efficiency class according to IEC 60034-30; 2008



Output kW	Motor type	Product code	Speed r/min	Efficiency IEC 60034-2-1; 2007			Power factor cos φ	Current			Torque			Moment of inertia J = 1/4 GD ² kgm ²	Weight kg	Sound pressure level L _{PA} dB
				Full load 100%	3/4 load 75%	1/2 load 50%		I _N A	I _s I _N	T _N Nm	T _l T _N	T _b T _N				
1000 r/min = 6-poles		400 V 50 Hz		GENELEC-design												
18.5	M4GP	200 MLC	3GGP 203 430-••J	987	92.5	92.8	92.4	0.84	34.3	8.1	178	3.2	3.4	0.49	305	61
22	M4GP	200 MLD	3GGP 203 440-••J	986	92.9	93.3	92.9	0.84	40.6	8.2	213	3.3	3.4	0.54	314	61
30	M4GP	225 SME	3GGP 223 250-••J	989	94.0	94.2	93.8	0.85	54.1	7.9	289	2.5	3.2	0.92	410	61
37	M4GP	250 SMD	3GGP 253 240-••J	990	94.4	94.8	94.6	0.84	67.3	8.2	356	3.3	3.3	1.74	500	65
45	M4GP	280 SMB	3GGP 283 220-••K	991	94.8	94.9	94.2	0.86	79.6	6.9	433	2.4	2.6	2.2	680	65
55	M4GP	280 SMC	3GGP 283 230-••K	990	95.1	95.1	94.7	0.86	97.0	6.8	530	2.4	2.6	2.85	725	65
75	M4GP	315 SMC	3GGP 313 230-••K	993	95.3	95.3	94.8	0.84	135	7.0	721	2.2	2.8	4.9	1000	67
90	M4GP	315 SMD	3GGP 313 240-••K	994	95.5	95.5	94.9	0.83	163	7.2	864	2.4	2.9	4.9	1040	67
110	M4GP	315 MLB	3GGP 313 420-••K	993	95.5	95.5	95.1	0.84	197	6.9	1057	2.3	2.7	6.3	1200	68
132	M4GP	315 LKA	3GGP 313 810-••K	993	95.7	95.7	95.4	0.83	239	6.9	1269	2.4	2.7	7.3	1410	68
160	M4GP	315 LKC	3GGP 313 830-••K	994	95.9	95.9	95.5	0.83	290	7.4	1537	2.7	2.9	9.2	1600	68
160	M4GP	355 SMB	3GGP 353 220-••K	995	95.9	95.9	95.5	0.83	290	7.0	1535	2.1	2.7	9.7	1680	73
200	M4GP	355 SMC	3GGP 353 230-••K	995	96.0	96.0	95.7	0.83	362	7.3	1919	2.3	2.8	11.3	1820	73
250	M4GP	355 MLB	3GGP 353 420-••K	995	96.0	96.0	95.8	0.83	452	7.1	2399	2.3	2.7	13.5	2180	73
315	M4GP	355 LKA	3GGP 353 810-••K	994	96.0	96.0	95.8	0.83	570	6.9	3026	2.3	2.6	15.5	2500	76
355	M4GP	355 LKB	3GGP 353 820-••K	995	96.0	96.0	95.6	0.80	667	7.7	3407	2.7	2.9	16.5	2600	76

The two bullets in the product code indicate choice of mounting arrangements, voltage and frequency code (see ordering information page).

I_s / I_N = Starting current
 T_l / T_N = Locked rotor torque
 T_b / T_N = Pull-out torque

Efficiency values are given according to IEC 60034-2-1; 2007. Please note that the values are not comparable without knowing the testing method. ABB has calculated the efficiency values according to indirect method, stray load losses (additional losses) determined from measuring.

Non-sparking aluminum motors Ex nA

Technical data for totally enclosed squirrel cage three phase motors

IE2



IP 55 - IC 411 - Insulation class F, temperature rise class B
IE2 efficiency class according to IEC 60034-30; 2008

Output kW	Motor type	Product code	Speed r/min	Efficiency IEC 60034-2-1; 2007			Power factor cos φ	Current		Torque			Moment of inertia J = 1/4 GD ² kgm ²	Weight kg	Sound pressure level L _{PA} dB	
				Full load 100%	3/4 load 75%	1/2 load 50%		I _N A	I _s A	T _N Nm	T _l Nm	T _b Nm				
3000 r/min = 2-poles			400 V 50 Hz			CENELEC-design										
0.18	M3AAN	63 A	3GAA 061 311-••C	2820	75.0	72.0	66.1	0.62	0.55	4.2	0.6	3.5	3.1	0.00013	3.9	54
0.25	M3AAN	63 B	3GAA 061 312-••C	2810	78.6	77.0	69.6	0.69	0.66	4.5	0.84	3.6	3.3	0.00016	4.4	54
0.37	M3AAN	71 A	3GAA 071 311-••E	2800	71.6	72.3	70.2	0.76	0.98	5.1	1.26	3.0	2.9	0.00035	4.9	58
0.55	M3AAN	71 B	3GAA 071 312-••E	2790	78.4	79.8	78.7	0.78	1.29	5.3	1.88	2.9	2.8	0.00045	5.9	58
0.75	M3AAN	80 B	3GAA 081 312-••E	2845	80.1	79.7	76.6	0.73	1.85	7.5	2.5	3.7	3.9	0.0009	10.5	60
1.1	M3AAN	80 C	3GAA 081 313-••E	2880	82.1	82.0	79.2	0.81	2.3	7.6	3.6	2.8	3.6	0.0012	11	60
1.5	M3AAN	90 L	3GAA 091 312-••E	2900	84.1	85.0	83.5	0.86	2.9	7.6	4.9	2.5	3.3	0.0024	16	60
2.2	M3AAN	90 LB	3GAA 091 313-••E	2875	84.6	85.7	85.5	0.85	4.4	6.9	7.3	2.8	3.2	0.0027	18	63
3	M3AAN	100 LB	3GAA 101 312-••E	2930	87.9	87.9	86.6	0.86	5.7	8.7	9.7	3.3	4.0	0.005	25	62
4	M3AAN	112 MB	3GAA 111 312-••E	2885	86.1	87.0	88.0	0.88	7.6	7.6	13.2	2.5	2.8	0.0062	30	68
5.5	M3AAN	132 SB	3GAA 131 312-••E	2915	88.0	88.5	87.6	0.82	11.0	7.9	18.0	2.6	3.6	0.016	42	73
7.5	M3AAN	132 SC	3GAA 131 313-••E	2915	88.5	88.7	88.1	0.87	14.0	7.6	24.5	2.2	3.2	0.022	56	73
11	M3AA	160 MLA	3GAA 161 031-••G	2938	90.7	91.5	91.1	0.91	19.2	7.5	35.7	2.4	3.1	0.044	91	69
15	M3AA	160 MLB	3GAA 161 036-••G	2934	91.5	92.5	92.2	0.91	26.0	7.5	48.8	2.5	3.3	0.053	105	69
18.5	M3AA	160 MLC	3GAA 161 037-••G	2932	92.0	93.1	93.1	0.92	31.5	7.5	60.2	2.9	3.4	0.063	123	69
22	M3AA	180 MLA	3GAA 181 031-••G	2952	92.2	92.7	92.2	0.87	39.5	7.7	71.1	2.8	3.3	0.076	132	69
30	M3AA	200 MLA	3GAA 201 035-••G	2956	93.1	93.5	92.9	0.90	51.6	7.7	96.9	2.7	3.1	0.178	210	72
37	M3AA	200 MLB	3GAA 201 036-••G	2959	93.4	93.7	93.0	0.90	63.5	8.2	119	3.0	3.3	0.196	225	72
45	M3AA	225 SMA	3GAA 221 031-••G	2961	93.6	93.9	93.1	0.88	78.8	6.7	145	2.5	2.5	0.244	263	74
55	M3AA	250 SMA	3GAA 251 031-••G	2967	94.1	94.4	93.8	0.88	95.8	6.8	177	2.2	2.7	0.507	304	75
75	M3AA	280 SMA	3GAA 281 031-••G	2968	94.5	94.8	94.3	0.89	128	7.1	241	2.5	2.8	0.583	389	75
90	¹⁾ M3AA	280 SMB	3GAA 281 032-••G	2971	95.0	95.2	94.8	0.89	153	7.8	289	2.6	3.2	0.644	425	75
3000 r/min = 2-poles			400 V 50 Hz			High-output design										
0.75	²⁾ M3AAN	71 C	3GAA 071 003-••E	2785	76.6	77.1	76.4	0.80	1.76	5.3	2.5	3.2	3.2	0.00056	6.5	58
1.5	¹⁾²⁾ M3AAN	80 C	3GAA 081 003-••E	2830	80.7	82.0	80.0	0.83	3.2	5.8	5.0	2.6	3.0	0.0011	11	60
2.7	¹⁾²⁾ M3AAN	90 LB	3GAA 091 003-••E	2860	81.0	81.2	79.0	0.86	5.5	7.0	9.0	2.6	3.0	0.0027	18	68
4	¹⁾²⁾ M3AAN	100 LB	3GAA 101 002-••E	2900	84.3	83.9	83.7	0.86	7.9	7.5	13.1	2.7	3.6	0.005	25	68
5.5	¹⁾²⁾ M3AAN	112 MB	3GAA 111 102-••E	2850	86.4	87.0	87.4	0.90	10.2	7.2	18.4	3.4	3.4	0.0062	30	68
9.2	¹⁾²⁾ M3AAN	132 SBB	3GAA 131 004-••E	2875	87.0	88.0	86.5	0.92	16.5	7.2	30.5	2.5	3.0	0.018	52	68
11	M3AAN	132 SMB	3GAA 131 315-••E	2900	90.3	90.8	90.4	0.87	20.2	8.5	36.2	2.7	3.7	0.01865	77	68
11	¹⁾²⁾ M3AAN	132 SC	3GAA 131 003-••E	2890	88.7	89.5	89.3	0.89	20.1	8.1	36.3	2.8	3.4	0.018	52	68
15	M3AAN	132 SMC	3GAA 131 316-••E	2905	90.4	90.7	89.8	0.84	28.5	9.1	49.3	3.3	4.0	0.02	81	69
18.5	M3AAN	132 SME	3GAA 131 317-••E	2895	91.1	92.2	92.4	0.89	32.9	9.7	61.0	3.2	4.3	0.02559	93	68
22	¹⁾²⁾ M3AAN	132 SME	3GAA 131 008-••E	2890	90.2	91.0	90.9	0.85	41.4	9.7	72.6	3.9	3.8	0.02559	91	69
30	M3AA	180 MLB	3GAA 181 032-••G	2950	92.8	93.5	93.3	0.88	53.0	7.9	97.1	2.8	3.3	0.092	149	69
45	M3AA	200 MLC	3GAA 201 033-••G	2957	93.3	93.8	93.2	0.88	79.1	8.1	145	3.1	3.3	0.196	225	72
55	M3AA	225 SMB	3GAA 221 032-••G	2961	93.9	94.3	93.6	0.88	96.0	6.5	177	2.4	2.5	0.274	286	74
75	M3AA	250 SMB	3GAA 251 032-••G	2970	94.6	94.9	94.4	0.89	128	7.6	241	2.8	3.1	0.583	351	75

¹⁾ Temperature rise class F

²⁾ Efficiency class IE1

The two bullets in the product code indicate choice of mounting arrangements, voltage and frequency code (see ordering information page).

I_s / I_N = Starting current
 T_l / T_N = Locked rotor torque
 T_b / T_N = Pull-out torque

Efficiency values are given according to IEC 60034-2-1; 2007. Please note that the values are not comparable without knowing the testing method. ABB has calculated the efficiency values according to indirect method, stray load losses (additional losses) determined from measuring.

Non-sparking aluminum motors Ex nA

Technical data for totally enclosed squirrel cage three phase motors

IE2



IP 55 - IC 411 - Insulation class F, temperature rise class B
IE2 efficiency class according to IEC 60034-30; 2008

Output kW	Motor type	Product code	Efficiency IEC 60034-2-1; 2007						Current					Moment of inertia J = 1/4 GD ² kgm ²	Weight kg	Sound pressure level L _{PA} dB
			Speed r/min	Full load 100%	3/4 load 75%	1/2 load 50%	Power factor cos φ	I _N A	I _s A	T _N Nm	T _l Nm	T _b Nm				
1500 r/min = 4-poles			400 V 50 Hz						GENELEC-design							
0.12	M3AAN	63 A	3GAA 062 311-••C	1400	65.5	60.4	51.7	0.57	0.46	3.1	0.81	2.7	2.8	0.00019	4.0	40
0.18	M3AAN	63 B	3GAA 062 312-••C	1380	67.3	63.9	56.7	0.62	0.62	3.1	1.24	2.5	2.6	0.00026	4.5	40
0.25	M3AAN	71 A	3GAA 072 311-••E	1365	65.1	66.0	62.7	0.76	0.72	4.0	1.74	2.0	2.1	0.00066	5.2	45
0.37	M3AAN	71 B	3GAA 072 312-••E	1355	69.7	71.9	71.1	0.79	0.96	3.8	2.6	2.0	2.2	0.0008	5.9	45
0.55	M3AAN	80 A	3GAA 082 311-••E	1375	74.1	75.9	75.0	0.78	1.37	4.5	3.8	1.9	2.2	0.0013	8.5	50
0.75	M3AAN	80 D	3GAA 082 314-••E	1415	79.9	80.4	78.6	0.75	1.8	5.8	5.0	2.6	2.8	0.0016	12	50
1.1	M3AAN	90 LB	3GAA 092 314-••E	1435	83.7	84.1	83.0	0.78	2.4	6.6	7.3	2.9	3.2	0.0043	16	50
1.5	M3AAN	90 LD	3GAA 092 315-••E	1435	84.2	84.1	81.9	0.76	3.3	7.0	9.9	3.1	3.5	0.0048	17	50
2.2	M3AAN	100 LC	3GAA 102 313-••E	1450	87.1	86.8	84.8	0.78	4.6	7.3	14.4	2.8	3.4	0.009	25	54
3	M3AAN	100 LD	3GAA 102 314-••E	1445	85.7	86.1	85.1	0.79	6.3	7.0	19.8	2.4	3.0	0.011	28	63
4	M3AAN	112 MB	3GAA 112 312-••E	1445	86.7	86.5	85.2	0.75	8.8	7.3	26.4	3.1	3.4	0.0126	34	64
5.5	M3AAN	132 M	3GAA 132 312-••E	1465	89.0	89.8	89.1	0.79	11.2	6.3	35.8	1.9	2.6	0.038	48	66
7.5	M3AAN	132 MA	3GAA 132 314-••E	1460	89.1	89.9	89.5	0.79	15.3	6.4	49.0	1.8	2.6	0.048	59	63
11	M3AA	160 MLA	3GAA 162 031-••G	1466	90.4	91.6	91.3	0.84	20.9	6.8	71.6	2.2	2.8	0.081	99	62
15	M3AA	160 MLB	3GAA 162 032-••G	1470	91.4	92.4	92.2	0.83	28.5	7.1	97.4	2.6	3.0	0.099	118	62
18.5	M3AA	180 MLA	3GAA 182 031-••G	1477	91.9	92.9	92.7	0.84	34.5	7.2	119	2.6	2.9	0.166	146	62
22	M3AA	180 MLB	3GAA 182 032-••G	1475	92.4	93.3	93.2	0.84	40.9	7.3	142	2.6	3.0	0.195	163	62
30	M3AA	200 MLA	3GAA 202 031-••G	1480	93.2	94.0	93.7	0.84	55.3	7.4	193	2.8	3.0	0.309	218	63
37	M3AA	225 SMA	3GAA 222 031-••G	1479	93.4	93.9	93.4	0.84	68.0	7.1	238	2.6	2.9	0.356	240	66
45	M3AA	225 SMB	3GAA 222 032-••G	1480	93.9	94.3	93.9	0.85	81.3	7.5	290	2.8	3.2	0.44	273	66
55	M3AA	250 SMA	3GAA 252 031-••G	1480	94.4	95.0	94.7	0.85	98.9	7.0	354	2.6	2.9	0.765	314	67
72	M3AA	280 SMA	3GAA 282 031-••G	1479	94.4	95.0	94.7	0.85	129	7.4	464	2.9	3.1	0.866	389	67
1500 r/min = 4-poles			400 V 50 Hz						High-output design							
0.55	M3AAN	71 C	3GAA 072 003-••E	1375	69.0	69.3	68.5	0.76	1.51	4.2	3.8	2.4	2.4	0.0011	6.5	45
0.95 ¹⁾²⁾	M3AAN	80 C	3GAA 082 003-••E	1395	76.0	76.9	76.3	0.80	2.2	5.2	6.5	2.5	2.6	0.0023	10.5	50
1.1 ¹⁾²⁾	M3AAN	80 C	3GAA 082 004-••E	1395	76.7	77.5	77.9	0.79	2.6	5.0	7.5	2.5	2.5	0.0023	10.5	50
1.85 ¹⁾²⁾	M3AAN	90 L	3GAA 092 003-••E	1390	79.3	78.5	78.7	0.80	4.2	4.5	12.7	2.2	2.4	0.0043	16	50
2.2 ¹⁾²⁾	M3AAN	90 LB	3GAA 092 004-••E	1390	80.0	80.9	79.5	0.83	4.7	4.5	15.1	2.2	2.4	0.0048	17	50
4 ¹⁾²⁾	M3AAN	100 LC	3GAA 102 003-••E	1420	83.2	83.3	81.7	0.82	8.4	5.5	26.8	2.5	2.8	0.009	25	60
5.5 ¹⁾²⁾	M3AAN	112 MB	3GAA 112 102-••E	1420	85.1	85.5	84.5	0.80	11.6	6.0	36.9	2.7	3.1	0.0126	34	64
9.2 ¹⁾	M3AAN	132 MBA	3GAA 132 004-••E	1455	89.8	90.5	89.5	0.84	17.6	7.5	60.3	2.1	2.8	0.048	59	59
11	M3AAN	132 SMB	3GAA 132 315-••E	1460	90.4	91.0	90.1	0.79	22.2	7.7	71.9	2.1	3.1	0.0433	83	65
15	M3AAN	132 SMD	3GAA 132 316-••E	1455	90.6	91.3	91.1	0.77	31.0	7.1	98.4	2.4	2.9	0.0517	92	67
18.5 ¹⁾²⁾	M3AAN	132 SMD	3GAA 132 007-••E	1445	89.4	90.0	89.5	0.78	38.2	6.7	122	2.3	2.6	0.05166	92	69
18.5	M3AA	160 MLC	3GAA 162 033-••G	1469	91.4	92.5	92.3	0.84	34.7	7.6	120	3.0	3.2	0.11	127	62
22	M3AA	160 MLD	3GAA 162 034-••G	1463	91.6	93.0	93.2	0.85	40.7	6.9	143	2.5	2.9	0.125	140	62
37	M3AA	200 MLB	3GAA 202 032-••G	1479	93.4	94.4	94.4	0.85	67.2	7.1	238	2.6	2.9	0.343	234	63
55	M3AA	225 SMC	3GAA 222 033-••G	1478	94.0	94.7	94.5	0.85	99.3	7.4	355	2.9	3.1	0.474	287	66
68	M3AA	250 SMB	3GAA 252 032-••G	1481	94.7	95.0	94.8	0.84	123	7.9	438	3.1	3.5	0.866	350	67

¹⁾ Temperature rise class F
²⁾ Efficiency class IE1

The two bullets in the product code indicate choice of mounting arrangements, voltage and frequency code (see ordering information page).

I_s / I_N = Starting current
T_l / T_N = Locked rotor torque
T_b / T_N = Pull-out torque

Efficiency values are given according to IEC 60034-2-1; 2007. Please note that the values are not comparable without knowing the testing method. ABB has calculated the efficiency values according to indirect method, stray load losses (additional losses) determined from measuring.

Non-sparking aluminum motors Ex nA

Technical data for totally enclosed squirrel cage three phase motors

IE2



IP 55 - IC 411 - Insulation class F, temperature rise class B
IE2 efficiency class according to IEC 60034-30; 2008

Output kW	Motor type	Product code	Speed r/min	Efficiency IEC 60034-2-1; 2007			Power factor cos φ	Current		Torque			Moment of inertia J = 1/4 GD ² kgm ²	Weight kg	Sound pressure level L _{PA} dB	
				Full load 100%	3/4 load 75%	1/2 load 50%		I _N A	I _s I _N	T _N Nm	T _l T _N	T _b T _N				
1000 r/min = 6-poles			400 V 50 Hz			CENELEC-design										
0.09	M3AAN	63 A	3GAA 063 311-••C	910	47.1	42.5	32.1	0.56	0.49	2.1	0.94	2.1	2.1	0.0002	4.0	38
0.12	M3AAN	63 B	3GAA 063 312-••C	910	57.5	54.0	46.2	0.58	0.51	2.1	1.25	2.1	2.1	0.00027	4.5	38
0.18	M3AAN	71 A	3GAA 073 311-••E	895	60.4	60.0	55.0	0.73	0.58	3.1	1.92	1.9	2.0	0.00092	5.5	42
0.25	M3AAN	71 B	3GAA 073 312-••E	895	64.0	63.6	59.5	0.71	0.79	3.3	2.6	2.2	2.2	0.0012	6.5	42
0.37	M3AAN	80 A	3GAA 083 311-••E	910	69.9	71.4	68.8	0.73	1.04	3.6	3.8	1.6	2.0	0.002	9.0	47
0.55	M3AAN	80 B	3GAA 083 312-••E	905	72.1	73.4	71.2	0.69	1.59	3.3	5.8	1.8	1.9	0.0026	10	47
0.75	M3AAN	90 LB	3GAA 093 313-••E	930	77.6	76.2	75.6	0.71	1.96	4.0	7.7	2.0	2.3	0.0048	18	44
1.1 ²⁾	M3AAN	90 LD	3GAA 093 314-••E	930	78.1	78.6	76.4	0.66	3.0	4.0	11.2	1.9	2.3	0.0056	20	44
1.5	M3AAN	100 LC	3GAA 103 312-••E	945	80.3	81.4	80.7	0.73	3.6	3.9	15.1	1.7	2.0	0.009	26	49
2.2 ²⁾	M3AAN	112 MB	3GAA 113 312-••E	940	81.8	83.1	82.5	0.73	5.3	4.4	22.3	1.8	2.2	0.01	28	56
3	M3AAN	132 S	3GAA 133 311-••E	960	83.3	83.6	81.7	0.65	7.9	4.3	29.8	1.6	2.3	0.031	39	57
4	M3AAN	132 MA	3GAA 133 312-••E	960	84.9	85.3	83.9	0.68	10.0	4.6	39.7	1.5	2.2	0.038	46	61
5.5	M3AAN	132 MC	3GAA 133 314-••E	965	86.1	86.1	84.3	0.67	13.7	6.2	54.4	2.5	2.8	0.049	59	61
7.5	M3AA	160 MLA	3GAA 163 031-••G	975	88.6	89.9	89.7	0.79	15.4	7.4	73.4	1.7	3.2	0.087	98	59
11	M3AA	160 MLB	3GAA 163 032-••G	972	89.3	90.7	90.6	0.79	22.5	7.5	108	1.9	2.9	0.114	125	59
15	M3AA	180 MLA	3GAA 183 031-••G	981	90.5	91.4	91.0	0.77	31.0	6.5	146	1.8	2.8	0.192	162	59
18.5	M3AA	200 MLA	3GAA 203 031-••G	988	91.6	92.3	91.7	0.80	36.4	6.7	178	2.3	2.9	0.382	196	63
22	M3AA	200 MLB	3GAA 203 032-••G	987	92.0	93.0	92.8	0.82	42.0	6.6	212	2.2	2.8	0.448	218	63
30	M3AA	225 SMA	3GAA 223 031-••G	986	92.7	93.3	92.9	0.83	56.2	7.0	290	2.6	2.9	0.663	266	63
37	M3AA	250 SMA	3GAA 253 031-••G	989	93.1	93.8	93.4	0.82	69.9	6.8	357	2.4	2.7	1.13	294	63
45 ¹⁾	M3AA	280 SMA	3GAA 283 031-••G	988	92.9	93.7	93.6	0.83	84.2	6.8	434	2.4	2.6	1.369	378	63
1000 r/min = 6-poles			400 V 50 Hz			High-output design										
0.37	M3AAN	71 C	3GAA 073 003-••E	870	61.5	61.2	59.0	0.72	1.2	3.1	4.0	2.5	2.4	0.0015	7	44
0.75 ¹⁾²⁾	M3AAN	80 C	3GAA 083 003-••E	905	70.1	70.3	69.1	0.76	2.0	3.9	7.9	2.5	2.4	0.0031	11	47
1.3 ¹⁾²⁾	M3AAN	90 LB	3GAA 093 003-••E	910	74.4	72.6	68.7	0.71	3.5	4.0	13.6	1.9	2.2	0.0048	18	44
2.2 ¹⁾²⁾	M3AAN	100 LC	3GAA 103 002-••E	940	78.0	74.0	71.2	0.71	5.7	4.5	22.3	1.9	2.3	0.009	26	49
3 ¹⁾²⁾	M3AAN	112 MB	3GAA 113 102-••E	920	79.7	80.5	80.3	0.75	7.2	3.8	31.1	1.9	2.2	0.0126	32	76
15 ²⁾	M3AA	160 MLC	3GAA 163 033-••G	967	88.7	90.5	90.5	0.76	32.1	6.3	148	2.0	2.9	0.131	138	59
30 ¹⁾²⁾	M3AA	200 MLC	3GAA 203 033-••G	985	91.6	92.8	92.5	0.82	57.6	6.9	290	2.3	2.8	0.531	245	63
37	M3AA	225 SMB	3GAA 223 034-••G	985	93.1	94.0	94.0	0.83	69.1	6.6	358	2.3	2.6	0.821	300	63
45	M3AA	250 SMB	3GAA 253 032-••G	989	93.4	94.1	93.9	0.83	83.7	7.0	434	2.5	2.7	1.369	341	63

¹⁾ Temperature rise class F

²⁾ Efficiency class IE1

The two bullets in the product code indicate choice of mounting arrangements, voltage and frequency code (see ordering information page).

I_s / I_N = Starting current

T_l / T_N = Locked rotor torque

T_b / T_N = Pull-out torque

Efficiency values are given according to IEC 60034-2-1; 2007. Please note that the values are not comparable without knowing the testing method. ABB has calculated the efficiency values according to indirect method, stray load losses (additional losses) determined from measuring.

Non-sparking aluminum motors Ex nA

Technical data for totally enclosed squirrel cage three phase motors



IP 55 - IC 411 - Insulation class F, temperature rise class B

Output kW	Motor type	Product code	Efficiency IEC 60034-2-1; 2007			Current					Torque		Moment of inertia J = 1/4 GD ² kgm ²	Weight kg	Sound pressure level L _{PA} dB	
			Speed r/min	Full load 100%	3/4 load 75%	1/2 load 50%	Power factor cos φ	I _N A	I _s I _N	T _N Nm	T _I T _N	T _b T _N				
750 r/min = 8-poles			400 V 50 Hz			GENELEC-design										
0.09	M3AAN	71 A	3GAA 074 001-••E	660	49.4	46.0	38.5	0.59	0.44	2.0	1.3	2.4	2.3	0.00092	5.5	40
0.12	M3AAN	71 B	3GAA 074 002-••E	670	51.4	47.5	39.9	0.56	0.6	2.1	1.71	2.8	2.4	0.0012	6.5	43
0.18	M3AAN	80 A	3GAA 084 001-••E	685	63.5	62.0	56.3	0.62	0.65	2.8	2.5	1.6	2.0	0.0018	8.5	45
0.25	M3AAN	80 B	3GAA 084 002-••E	685	67.1	67.2	63.4	0.63	0.85	2.8	3.4	1.4	1.9	0.0024	9.5	50
0.37	M3AAN	90 S	3GAA 094 001-••E	695	59.4	56.3	49.1	0.54	1.66	2.7	5.0	1.6	2.1	0.0032	13	52
0.55	M3AAN	90 L	3GAA 094 002-••E	660	59.1	59.5	55.2	0.58	2.3	2.1	7.9	1.5	1.6	0.0043	16	52
0.75	M3AAN	100 LA	3GAA 104 001-••E	720	70.7	67.1	59.9	0.47	3.2	3.9	9.9	2.8	3.6	0.0069	20	46
1.1	M3AAN	100 LB	3GAA 104 002-••E	695	76.0	76.5	74.6	0.66	3.1	3.4	15.1	1.7	2.2	0.0082	23	53
1.5	M3AAN	112 M	3GAA 114 101-••E	690	74.4	75.9	74.1	0.70	4.1	3.2	20.7	1.4	1.9	0.01	28	55
2.2	M3AAN	132 S	3GAA 134 001-••E	715	82.9	83.0	80.8	0.62	6.1	3.4	29.3	1.3	1.9	0.0038	46	56
3	M3AAN	132 M	3GAA 134 002-••E	715	79.9	80.8	79.1	0.64	8.4	3.2	40.0	1.2	1.8	0.0045	53	58
4	M3AA	160 MLA	3GAA 164 031-••G	728	84.1	85.1	83.7	0.67	10.2	5.4	52.4	1.5	2.6	0.068	84	59
5.5	M3AA	160 MLB	3GAA 164 032-••G	726	84.7	86.0	84.9	0.67	13.9	5.6	72.3	1.4	2.6	0.085	98	59
7.5	M3AA	160 MLC	3GAA 164 033-••G	727	86.1	87.3	86.6	0.65	19.3	4.7	98.5	1.5	2.8	0.132	137	59
11	M3AA	180 MLA	3GAA 184 031-••G	731	86.8	88.4	87.8	0.67	27.3	4.4	143	1.8	2.6	0.214	175	59
15	M3AA	200 MLA	3GAA 204 031-••G	737	90.2	91.3	90.9	0.74	32.4	5.3	194	2.0	2.4	0.45	217	60
18.5	M3AA	225 SMA	3GAA 224 031-••G	739	91.0	92.0	91.5	0.73	40.1	5.2	239	2.0	2.3	0.669	266	63
22	M3AA	225 SMB	3GAA 224 032-••G	738	91.6	92.4	92.0	0.74	46.8	5.5	284	2.0	2.3	0.722	279	63
30	M3AA	250 SMA	3GAA 254 031-••G	742	92.4	92.9	92.3	0.71	66.0	5.8	386	2.6	2.4	1.404	340	63
37	M3AA	280 SMA	3GAA 284 031-••G	740	92.3	93.0	92.7	0.74	78.1	5.6	477	2.4	2.3	1.505	403	63
750 r/min = 8-poles			400 V 50 Hz			High-output design										
0.18	¹⁾ M3AAN	71 C	3GAA 074 003-••E	660	47.2	44.8	45.0	0.66	0.83	2.2	2.6	2.3	2.2	0.0015	7	40
0.37	¹⁾ M3AAN	80 C	3GAA 084 003-••E	700	57.5	56.0	55.0	0.62	1.49	3.3	5.0	2.5	2.5	0.0031	11	45
0.75	¹⁾ M3AAN	90 LB	3GAA 094 003-••E	680	63.1	59.8	53.0	0.60	2.8	3.0	10.5	1.8	2.0	0.0048	18	43
1.5	¹⁾ M3AAN	100 LC	3GAA 104 003-••E	670	70.0	65.2	63.8	0.70	4.4	3.3	21.3	1.8	2.2	0.009	26	46
2	¹⁾ M3AAN	112 MB	3GAA 114 102-••E	685	73.2	72.5	70.0	0.69	5.7	3.4	27.8	2.1	2.3	0.0126	32	52

¹⁾ Temperature rise class F

The two bullets in the product code indicate choice of mounting arrangements, voltage and frequency code (see ordering information page).

I_s / I_N = Starting current
T_I / T_N = Locked rotor torque
T_b / T_N = Pull-out torque

Efficiency values are given according to IEC 60034-2-1; 2007. Please note that the values are not comparable without knowing the testing method. ABB has calculated the efficiency values according to indirect method, stray load losses (additional losses) determined from measuring.

Non-sparking cast iron motors variant codes

Code ¹⁾	Variant	Frame size														
		80	90	100	112	132	160	180	200	225	250	280	315	355	400	450
Administration																
531	Sea freight packing	M	M	M	M	M	M	M	M	M	M	M	M	M	P	P
Balancing																
417	Vibration acc. to Grade B (IEC 60034-14). Note: not available for 450 frame size 2-pole	P	P	P	P	P	P	P	P	P	P	P	P	P	P	R
423	Balanced without key	P	P	P	P	P	P	P	P	P	P	P	P	P	P	P
424	Full key balancing.	P	P	P	P	P	P	P	P	P	P	P	P	P	P	P
Bearings and Lubrication																
036	Transport lock for bearings.	NA	NA	NA	NA	NA	M	M	M	M	M	M	M	M	P	P
037	Roller bearing at D-end.	NA	NA	NA	NA	NA	M	M	M	M	M	M	M	M	P	P
040	Heat resistant grease.	S	S	S	S	S	P	P	P	P	P	P	P	P	P	P
041	Bearings regreasable via grease nipples.	NA	NA	NA	NA	NA	S	S	S	S	S	S	S	S	S	S
043	SPM compatible nipples for vibration measurement	NA	NA	NA	NA	NA	S	S	S	S	S	S	S	S	S	S
058	Angular contact bearing at D-end, shaft force away from bearing.	NA	NA	NA	NA	NA	P	P	P	P	P	P	P	P	P	P
059	Angular contact bearing at N-end, shaft force towards bearing.	NA	NA	NA	NA	NA	P	P	P	P	P	P	P	P	P	P
060	Angular contact bearing at D-end, shaft force towards bearing.	NA	NA	NA	NA	NA	NA	NA	NA	NA	NA	P	P	P	P	P
061	Angular contact bearing at N-end, shaft force away from bearing.	NA	NA	NA	NA	NA	NA	NA	NA	NA	NA	P	P	P	P	P
107	Pt100 2-wire in bearings.	NA	NA	NA	NA	NA	P	P	P	P	P	P	P	P	P	P
128	Double PT100, 2-wire in bearings	NA	NA	NA	NA	NA	P	P	P	P	P	P	P	P	P	P
129	Double PT100, 3-wire in bearings	NA	NA	NA	NA	NA	P	P	P	P	P	P	P	P	P	P
130	Pt100 3-wire in bearings.	NA	NA	NA	NA	NA	P	P	P	P	P	P	P	P	P	P
194	2Z bearings greased for life at both ends.	S	S	S	S	S	M	M	M	M	M	NA	NA	NA	NA	NA
433	Outlet grease collector	NA	NA	NA	NA	NA	NA	NA	NA	NA	NA	P	P	P	P	P
506	Nipples for vibration measurement : SKF Marlin Quick Connect stud CMSS-2600-3	NA	NA	NA	NA	NA	P	P	P	P	P	P	P	P	P	P
654	Provision for vibration sensors (M8x1)	NA	NA	NA	NA	NA	P	P	P	P	P	P	P	P	P	P
795	Lubrication information plate	NA	NA	NA	NA	NA	M	M	M	M	M	S	S	S	S	S
796	Grease nipples JIS B 1575 PT 1/8 Type A	NA	NA	NA	NA	NA	P	P	P	P	P	P	P	P	P	P
797	Stainless steel SPM Nipples	NA	NA	NA	NA	NA	P	P	P	P	P	P	P	P	P	P
798	Stainless steel grease nipples	NA	NA	NA	NA	NA	P	P	P	P	P	P	P	P	P	P
799	Grease nipples flat type DIN 3404, thread M10x1	NA	NA	NA	NA	NA	M	M	M	M	M	M	M	M	P	P
800	Grease nipples JIS B 1575 PT 1/8" pin type	NA	NA	NA	NA	NA	P	P	P	P	P	P	P	P	P	P
Branch standard designs																
178	Stainless steel / acid proof bolts.	S	S	S	S	S	M	M	M	M	M	M	M	M	P	P
204	Jacking bolts for foot mounted motors.	NA	NA	NA	NA	NA	P	P	P	P	P	P	P	S	S	S
209	Non-standard voltage or frequency, (special winding).	P	P	P	P	P	P	P	P	P	P	P	P	P	P	P
396	Motor designed for ambient temperature -20°C to -40°C, with space heaters (code 450/451 must be added).	P	P	P	P	P	P	P	P	P	P	P	P	P	P	P
397	Motor designed for ambient temperature -40°C to -55°C, with space heaters (code 450/451 must be added).	P	P	P	P	P	P	P	P	P	P	P	P	P	P	P

¹⁾ Certain variant codes cannot be used simultaneously.

S = Included as standard
P = New manufacture only
M = On modification of a stocked motor; or on new manufacture, the number of number per order may be limited.
R = On request
NA = Not applicable.

Code ¹⁾	Variant	Frame size														
		80	90	100	112	132	160	180	200	225	250	280	315	355	400	450
398	Motor designed for ambient temperature -20°C to -40°C.	P	P	P	P	P	P	P	P	P	P	P	P	P	P	P
399	Motor designed for ambient temperature -40°C to -55°C.	P	P	P	P	P	P	P	P	P	P	P	P	P	P	P
425	Corrosion protected stator and rotor core.	S	S	S	S	S	S	S	S	S	S	P	P	P	P	P
786	Special design shaft upwards (V3, V36, V6) for outdoor mounting.	P	P	P	P	P	P	P	P	P	P	R	R	NA	NA	NA
Cooling system																
044	Unidirectional fan for reduced noise level. Rotation clockwise seen from D-end. Available only for 2-pole motors.	NA	NA	NA	NA	NA	NA	NA	NA	NA	NA	P	P	P	S	S
045	Unidirectional fan for reduced noise level. Rotation counter clockwise seen from D-end. Available only for 2-pole motors.	NA	NA	NA	NA	NA	NA	NA	NA	NA	NA	P	P	P	S	S
068	Light alloy metal fan	M	M	M	M	M	M	M	M	M	M	M	M	M	P	P
183	Separate motor cooling (fan axial, N-end).	NA	NA	NA	NA	NA	P	P	P	P	P	P	P	P	P	P
206	Steel fan	NA	NA	NA	NA	NA	P	P	P	P	P	P	P	P	P	NA
422	Separate motor cooling (fan top, N-end).	NA	NA	NA	NA	NA	NA	NA	NA	NA	NA	P	P	P	P	P
791	Stainless steel fan cover	NA	NA	NA	NA	NA	NA	NA	NA	P	P	P	P	P	P	P
Coupling																
035	Assembly of customer supplied coupling-half.	NA	NA	NA	NA	NA	NA	NA	NA	NA	NA	P	P	P	P	P
Documentation																
141	Binding dimension drawing.	M	M	M	M	M	M	M	M	M	M	M	M	M	P	P
Drain holes																
065	Plugged existing drain holes.	NA	NA	NA	NA	NA	M	M	M	M	M	M	M	M	P	P
448	Draining holes with metal plugs.	NA	NA	NA	NA	NA	P	P	P	P	P	P	P	P	P	P
Earthing Bolt																
067	External earthing bolt.	S	S	S	S	S	S	S	S	S	S	S	S	S	S	S
Hazardous Environments																
452	DIP/Ex tD acc. to ATEX directive 94/9/EC , T= 125 °C, cat. 3D, IP55	M	M	M	M	M	M	M	M	M	M	M	M	M	P	P
453	DIP/Ex tD acc. to ATEX directive 94/9/EC , T= 125 °C, cat. 2D, IP65	M	M	M	M	M	M	M	M	M	M	M	M	P	P	NA
454	DIP/Ex tD acc. to ATEX directive 94/9/EC , T= 125 °C, cat. 3D, IP65	M	M	M	M	M	M	M	M	M	M	P	P	P	P	NA
456	Ex nA design, fulfilling IEC 60079-15, with certificate.	M	M	M	M	M	M	M	M	M	M	P	P	P	P	P
480	Ex nA II acc. to ATEX directive 94/9/EC, temp. class T3.	S	S	S	S	S	S	S	S	S	S	S	S	S	S	S
804	DIP/Ex tD, IEC 61241, T125 °C, IP55 (zone 22).	M	M	M	M	M	M	M	M	M	M	M	M	M	P	NA
805	DIP/Ex tD, IEC 61241, T125 °C, IP65 (zone 21).	P	P	P	P	P	M	M	M	M	M	P	P	P	P	NA
806	DIP/Ex tD, IEC 61241, T125 °C, IP65 (zone 22).	P	P	P	P	P	M	M	M	M	M	P	P	P	P	NA
807	CSA design, Class I, Div 2 Group A, B, C, D T3	NA	NA	NA	NA	NA	NA	NA	P	P	P	P	P	P	P	P
814	Ex tD (DIP) motors, temperature class T 150C.	M	M	M	M	M	M	M	M	M	M	M	M	P	P	P
Heating elements																
450	Heating element, 100-120V.	M	M	M	M	M	M	M	M	M	M	M	M	M	P	P
451	Heating element, 200-240V.	M	M	M	M	M	M	M	M	M	M	M	M	M	P	P
Insulation system																
014	Winding insulation class H.	P	P	P	P	P	P	P	P	P	P	P	P	P	P	P
405	Special winding insulation for frequency converter supply.	P	P	P	P	P	P	P	P	P	P	P	P	P	P	P

¹⁾ Certain variant codes cannot be used simultaneously.

S = Included as standard
P = New manufacture only
M = On modification of a stocked motor; or on new manufacture, the number of number per order may be limited.
R = On request
NA = Not applicable.

Code ¹⁾	Variant	Frame size														
		80	90	100	112	132	160	180	200	225	250	280	315	355	400	450
Mounting arrangements																
008	IM 2101 foot/flange mounted, IEC flange, from IM 1001 (B34 from B3).	M	M	M	M	M	NA	NA	NA	NA	NA	NA	NA	NA	NA	
009	IM 2001 foot/flange mounted, IEC flange, from IM 1001 (B35 from B3).	M	M	M	M	M	M	M	M	M	M	M	M	M	P	P
047	IM 3601 flange mounted, IEC flange, from IM 3001 (B14 from B5).	M	M	M	M	M	NA	NA	NA	NA	NA	NA	NA	NA	NA	
066	Modified for specified mounting position differing from IM B3 (1001), IM B5 (3001), B14 (3601), IM B35 (2001) & IM B34 (2101)	M	M	M	M	M	M	M	M	M	M	M	M	M	P	P
228	Flange FF 130.	P	P	P	P	NA	NA	NA	NA	NA	NA	NA	NA	NA	NA	
229	Flange FT 130.	M	P	NA	NA	NA	NA	NA	NA	NA	NA	NA	NA	NA	NA	
305	Additional lifting lugs.	NA	NA	NA	NA	NA	NA	NA	NA	NA	NA	P	P	P	P	
Painting																
111	Painting system C3M acc. to ISO 12944-5:2007	S	S	S	S	S	S	S	S	S	S	S	S	S	S	NA
114	Special paint colour, standard grade.	M	M	M	M	M	M	M	M	M	M	M	M	M	P	P
115	Painting system C4M acc. To ISO 12944-5: 2007	P	P	P	P	P	P	P	P	P	P	P	P	P	P	P
168	Primer paint only.	P	P	P	P	P	P	P	P	P	P	P	P	P	P	P
754	Painting system C5M acc. to ISO 12944-5:2007	P	P	P	P	P	P	P	P	P	P	P	P	P	P	P
755	Aluminium metallizing and painting according to NORSOK M501 revision 5, Method 2A (only available color RAL 7038)	P	P	P	P	P	P	P	P	P	P	P	P	P	P	P
Protection																
005	Metal protective roof, vertical motor, shaft down.	M	M	M	M	M	M	M	M	M	M	M	M	M	P	P
072	Radial seal at D-end.	M	M	M	M	M	M	M	M	M	M	M	M	P	P	P
073	Sealed against oil at D-end.	P	P	P	P	P	P	P	P	P	P	P	P	P	P	P
076	Draining holes with plugs in open position.	P	P	P	P	P	S	S	S	S	S	S	S	S	S	S
158	Degree of protection IP65.	M	M	M	M	M	M	M	M	M	M	M	M	M	P	P
401	Protective roof, horizontal motor.	P	P	P	P	P	P	P	P	P	P	P	P	P	P	P
403	Degree of protection IP56.	M	M	M	M	M	M	M	M	M	M	M	M	M	P	P
434	Degree of protection IP56, open deck.	NA	NA	NA	NA	NA	P	P	P	P	P	P	P	P	P	R
783	Labyrinth sealing at D-end.	P	P	P	P	P	P	P	P	P	P	P	P	P	S	S
Rating & instruction plates																
002	Restamping voltage, frequency and output, continuous duty.	M	M	M	M	M	M	M	M	M	M	M	M	M	P	P
004	Additional text on std rating plate (max 12 digits on free text line).	P	P	P	P	P	P	P	P	P	P	P	P	P	P	P
095	Restamping output (maintained voltage, frequency), intermittent duty.	P	P	P	P	P	P	P	P	P	P	P	P	P	P	P
126	Tag plate	P	P	P	P	P	P	P	P	P	P	P	P	P	P	P
135	Mounting of additional identification plate, stainless.	M	M	M	M	M	M	M	M	M	M	M	M	M	P	P
139	Additional identification plate delivered loose.	M	M	M	M	M	M	M	M	M	M	M	M	M	P	P
161	Additional rating plate delivered loose.	M	M	M	M	M	M	M	M	M	M	M	M	M	P	P
163	Frequency converter rating plate. Rating data according to quotation.	M	M	M	M	M	M	M	M	M	M	M	M	M	P	P

¹⁾ Certain variant codes cannot be used simultaneously.

S = Included as standard
P = New manufacture only
M = On modification of a stocked motor; or on new manufacture, the number of number per order may be limited.
R = On request
NA = Not applicable.

Code ¹⁾	Variant	Frame size													
		80	90	100	112	132	160	180	200	225	250	280	315	355	400
Shaft & rotor															
069	Two shaft extensions as per basic catalogue.	P	P	P	P	P	P	P	P	P	P	P	P	P	P
070	One or two special shaft extensions, standard shaft material.	P	P	P	P	P	P	P	P	P	P	P	P	P	P
164	Shaft extension with closed key-way.	S	S	S	S	S	S	S	S	S	S	P	P	P	NA
165	Shaft extension with open key-way.	P	P	P	P	P	P	P	P	P	P	S	S	S	S
410	Stainless steel shaft (standard or non-standard design).	R	R	R	R	R	R	R	R	R	R	P	P	P	P
Standards and Regulations															
151	Design according to SHELL DEP 33.66.05.31-Gen. June 2007	M	M	M	M	M	M	M	M	M	M	P	P	P	P
421	VIK design (Verband der Industriellen Energie- und Kraftwirtschaft e.V.).	P	P	P	P	P	P	P	M	M	M	P	P	P	R
482	Design according to Neste OY & Jacobs, specification N-114 E, rev 3, 21.03.2002	P	P	P	P	P	P	P	P	P	P	P	P	P	P
504	Design according to Neste OY & Jacobs, specification N-114 E, rev 3, 21.03.2002 with SPM adapter	P	P	P	P	P	P	P	P	P	P	P	P	P	P
505	VIK design with ABB standard shaft dimensions (Verband der Industriellen Energie- und Kraftwirtschaft e.V.).	P	P	P	P	P	P	P	P	P	P	P	P	P	NA
540	China energy label	M	M	M	M	M	M	M	M	M	M	M	M	NA	NA
756	EDF - UTO First type qualification	NA	NA	NA	NA	NA	P	P	P	P	P	NA	NA	NA	NA
757	EDF - UTO	NA	NA	NA	NA	NA	P	P	P	P	P	NA	NA	NA	NA
774	Design according to NORSOK (Norwegian Territorial Waters)excluding surface treatment.	P	P	P	P	P	P	P	P	P	P	P	P	P	P
775	Design according to SHELL DEP 33.66.05.31-Gen. January 1999 design.	M	M	M	M	M	M	M	M	M	M	M	M	P	NA
778	GOST Export/Import Certificate (Russia). (must be orderd with variant code 456)	P	P	P	P	P	P	P	P	P	P	P	P	P	P
779	SASO Export/Import Certificate (Saudi Arabia)	P	P	P	P	P	M	M	M	M	M	M	M	P	P
782	Fulfilling CQST Certification requirements (China)	M	M	M	M	M	M	M	M	M	M	M	M	P	P
788	Documentation for Korean KOSHA certification	P	P	P	P	P	M	M	M	M	M	M	M	P	NA
802	GOST Kazakhstan certified	P	P	P	P	P	P	P	P	P	P	P	P	P	NA
Stator winding temperature sensors															
120	KTY 84-130 (1 per phase) in stator winding.	NA	NA	NA	NA	NA	P	P	P	P	P	P	P	P	P
328	PTC - thermistors (3 in series), 120°C, in stator winding	M	M	M	M	M	M	M	M	M	M	M	M	M	P
435	PTC - thermistors (3 in series), 130°C, in stator winding.	M	M	M	M	M	M	M	M	M	M	M	M	M	P
436	PTC - thermistors (3 in series), 150°C, in stator winding.	NA	NA	NA	NA	NA	NA	NA	NA	NA	NA	S	S	S	S
439	PTC - thermistors (2x3 in series), 150°C, in stator winding.	P	P	P	P	P	M	M	M	M	M	M	M	M	P
441	PTC - thermistors (3 in series, 130°C & 3 in series, 150°C), in stator winding.	P	P	P	P	P	P	P	P	P	P	P	P	P	P
445	Pt-100 2-wire in stator winding, 1 per phase	P	P	P	P	P	P	P	P	P	P	P	P	P	P
446	Pt-100 2-wire in stator winding, 2 per phase	NA	NA	NA	NA	NA	P	P	P	P	P	P	P	P	P
502	Pt-100 3-wire in stator winding, 1 per phase.	NA	NA	NA	NA	NA	P	P	P	P	P	P	P	P	P
503	Pt-100 3-wire in stator winding, 2 per phase.	NA	NA	NA	NA	NA	P	P	P	P	P	P	P	P	P

¹⁾ Certain variant codes cannot be used simultaneously.

S = Included as standard
P = New manufacture only
M = On modification of a stocked motor; or on new manufacture, the number of number per order may be limited.
R = On request
NA = Not applicable.

Code ¹⁾	Variant	Frame size													
		80	90	100	112	132	160	180	200	225	250	280	315	355	400
Terminal box															
019	Larger than standard terminal box.	NA	NA	NA	NA	NA	NA	NA	NA	NA	NA	P	P	P	NA
021	Terminal box LHS (seen from D-end).	NA	NA	NA	NA	NA	P	P	P	P	P	P	P	P	NA
022	Cable entry LHS (seen from D-end).	M	M	M	M	M	M	M	M	M	M	M	M	P	P
157	Terminal box degree of protection IP65.	M	M	M	M	M	M	M	M	M	M	M	M	P	NA
180	Terminal box RHS (seen from D-end).	NA	NA	NA	NA	NA	P	P	P	P	P	P	P	P	NA
277	Cable sealing end unit, size small for C-opening	NA	NA	NA	NA	NA	NA	NA	NA	NA	NA	P	NA	NA	NA
278	Cable sealing end unit, size medium for D-opening	NA	NA	NA	NA	NA	NA	NA	NA	NA	NA	P	P	P	P
279	Cable sealing end unit, size large for D-opening	NA	NA	NA	NA	NA	NA	NA	NA	NA	NA	P	P	P	P
292	Adapter C-C	NA	NA	NA	NA	NA	NA	NA	NA	NA	NA	P	NA	NA	NA
293	Adapter D-D	NA	NA	NA	NA	NA	NA	NA	NA	NA	NA	P	P	NA	NA
294	Adapter E-D	NA	NA	NA	NA	NA	NA	NA	NA	NA	NA	P	P	P	P
295	Adapter E-2D	NA	NA	NA	NA	NA	NA	NA	NA	NA	NA	P	P	P	S
296	Adapter E-3D	NA	NA	NA	NA	NA	NA	NA	NA	NA	NA	NA	NA	NA	P
300	Increased single core cross section	P	P	P	P	P	P	P	P	P	P	P	P	P	P
380	Separate terminal box for temperature detectors, std. material	NA	NA	NA	NA	NA	P	P	P	P	P	P	P	P	P
400	4 x 90 degr turnable terminal box.	S	S	S	S	S	S	S	S	S	S	S	S	NA	NA
402	Terminal box adapted for Al cables.	NA	NA	NA	NA	NA	NA	NA	NA	NA	NA	S	S	S	S
413	Extended cable connection, no terminal box.	NA	NA	NA	NA	NA	P	P	P	P	P	P	P	P	NA
418	Separate terminal box for auxiliaries, standard material.	NA	NA	NA	NA	NA	P	P	P	P	P	P	P	P	P
447	Top mounted separate terminal box for monitoring equipment.	NA	NA	NA	NA	NA	NA	NA	NA	NA	NA	M	M	M	NA
466	Terminal box at N-end.	NA	NA	NA	NA	NA	NA,R	NA,R	P	P	P	P	P	P	P
468	Cable entry from D-end.	M	M	M	M	M	M	M	M	M	M	M	M	P	NA
469	Cable entry from N-end.	M	M	M	M	M	M	M	M	M	M	M	M	P	NA
567	Separate terminal box material: Cast Iron	NA	NA	NA	NA	NA	P	P	P	P	P	P	P	P	P
568	Separate terminal box for heating elements, std. material	NA	NA	NA	NA	NA	P	P	P	P	P	P	P	P	P
569	Separate terminal box for brakes	NA	NA	NA	NA	NA	P	P	P	P	P	NA	NA	NA	NA
728	Standard cable gland, Ex d IIB, armoured cable, double sealing.	P	P	P	P	P	P	P	P	P	P	P	P	P	P
730	Prepared for NPT cable glands	P	P	P	P	P	P	P	P	P	P	P	P	P	P
732	Standard cable gland, Ex d IIB, armoured cable.	M	M	M	M	M	M	M	M	M	M	M	M	P	P
733	Standard cable gland, Ex d IIB, non-armoured cable.	P	P	P	P	P	P	P	P	P	P	P	P	P	P
734	Standard cable gland, Ex d IIC, armoured cable.	M	M	M	M	M	M	M	M	M	M	M	M	P	P
736	Standard cable gland Ex e acc. to EN-standards.	S	S	S	S	S	S	S	S	S	S	S	S	S	S
737	Standard cable gland Ex e with clamping device acc. to EN-standards.	P	P	P	P	P	P	P	P	P	P	P	P	P	P
741	Motor equipped with Ex e terminal box (EN 50019).	P	P	P	P	P	P	P	P	P	P	P	P	P	P
743	Painted non-drilled flange in steel for cable glands	M	M	M	M	M	M	M	M	M	M	M	M	M	P
744	Stainless steel non-drilled flange for cable glands.	M	M	M	M	M	M	M	M	M	M	M	M	M	P
745	Painted steel flange equipped with nickle plated brass cable glands	M	M	M	M	M	M	M	M	M	M	M	M	M	P
746	Stainless steel cable flange equipped with standard nickle plated brass cable glands	P	P	P	P	P	P	P	P	P	P	P	P	P	P

¹⁾ Certain variant codes cannot be used simultaneously.

S = Included as standard
P = New manufacture only
M = On modification of a stocked motor; or on new manufacture, the number of number per order may be limited.
R = On request
NA = Not applicable.

Code ¹⁾	Variant	Frame size														
		80	90	100	112	132	160	180	200	225	250	280	315	355	400	450
Testing																
145	Type test report from a catalogue motor, 400V 50Hz.	M	M	M	M	M	M	M	M	M	M	M	M	M	P	P
146	Type test with report for one motor from specific delivery batch.	P	P	P	P	P	P	P	P	P	P	P	P	P	P	P
148	Routine test report.	M	M	M	M	M	M	M	M	M	M	M	M	M	P	P
150	Customer witnessed testing. Specify test procedure with other codes.	P	P	P	P	P	P	P	P	P	P	P	P	P	P	P
222	Torque/speed curve, type test and multi-point load test with report for one motor from specific delivery batch.	P	P	P	P	P	P	P	P	P	P	P	P	P	P	P
760	Vibration level test	M	M	M	M	M	M	M	M	M	M	M	M	M	P	P
761	Vibration spectrum test for one motor from specific delivery batch.	P	P	P	P	P	P	P	P	P	P	P	P	P	P	P
762	Noise level test for one motor from specific delivery batch.	P	P	P	P	P	P	P	P	P	P	P	P	P	P	P
763	Noise spectrum test for one motor from specific delivery batch.	P	P	P	P	P	P	P	P	P	P	P	P	P	P	P
764	Test for one motor from specific delivery batch with ABB frequency converter available at ABB test field. ABB standard test procedure.	P	P	P	P	P	P	P	P	P	P	P	P	P	P	P
Variable speed drives																
181	Rating plate with ABB standard loadability values for VSD operation. Other auxiliaries for VSD operation to be selected as necessary.	M	M	M	M	M	M	M	M	M	M	M	M	M	P	P
470	Prepared for hollow shaft pulse tacho (L&L equivalent).	NA	NA	NA	NA	NA	P	P	P	P	P	P	P	P	P	P
479	Mounting of other type of pulse tacho with shaft extension, tacho not included.	NA	NA	NA	NA	NA	P	P	P	P	P	P	P	P	P	P
680	2048 pulse tacho, Ex d, tD, L&L 841910001	NA	NA	NA	NA	NA	P	P	P	P	P	P	P	P	P	P
701	Insulated bearing at N-end.	NA	NA	NA	NA	NA	NA	NA	NA	NA	NA	M	M	M	P	P
704	EMC cable gland.	P	P	P	P	P	P	P	P	P	P	P	P	P	P	P
747	1024 pulse tacho, Ex d, tD, L&L 841910002	NA	NA	NA	NA	NA	P	P	P	P	P	P	P	P	P	P
Y/Δ starting																
117	Terminals for Y/Δ start at both speeds (two speed windings).	NA	NA	NA	NA	NA	R	R	R	R	R	P	P	R	R	R
118	Terminals for Y/Δ start at high speed (two speed windings).	NA	NA	NA	NA	NA	R	R	R	R	R	P	P	R	R	R
119	Terminals for Y/Δ start at low speed (two speed windings).	NA	NA	NA	NA	NA	R	R	R	R	R	P	P	R	R	R

¹⁾ Certain variant codes cannot be used simultaneously.

S = Included as standard
P = New manufacture only
M = On modification of a stocked motor; or on new manufacture, the number of number per order may be limited.
R = On request
NA = Not applicable.

Non-sparking aluminum motors variant codes

Code ¹⁾	Variant	Frame size												
		63	71	80	90	100	112	132	160	180	200	225	250	280
Balancing														
417	Vibration acc. to Grade B (IEC 60034-14).	NA	NA	NA	P	P	P	P	R	P	R	R	R	R
423	Balanced without key.	NA	NA	NA	P	P	P	P	R	R	R	R	R	R
424	Full key balancing.	NA	NA	NA	P	P	P	P	P	P	P	P	P	P
Bearings and Lubrication														
036	Transport lock for bearings.	NA	NA	NA	M	M	M	M	M	M	M	M	M	M
037	Roller bearing at D-end.	NA	NA	NA	P	P	P	P	M	M	M	M	M	M
039	Cold resistant grease.	M	M	M	M	M	M	M	R	R	R	R	R	M
040	Heat resistant grease.	M	M	M	M	M	M	M	S	S	S	S	S	S
041	Bearings regreasable via grease nipples.	NA	NA	NA	P	P	P	P	M	M	S	S	S	S
043	SPM compatible nipples for vibration measurement	NA	NA	NA	R	R	R	R	M	M	M	M	M	M
057	2RS bearings at both ends.	M	M	M	M	M	M	M	M	M	M	M	M	M
058	Angular contact bearing at D-end, shaft force away from bearing.	NA	NA	NA	M	M	M	M	M	M	M	M	M	M
059	Angular contact bearing at N-end, shaft force towards bearing.	NA	NA	NA	M	M	M	M	M	M	M	M	M	M
061	Angular contact bearing at N-end, shaft force away from bearing.	NA	NA	NA	NA	NA	NA	NA	NA	NA	P	NA	NA	NA
188	63-series bearings.	NA	NA	NA	M	S	M	M	S	S	S	S	S	S
194	ZZ bearings greased for life at both ends.	S	S	S	NA	NA	NA	NA	S	S	R	R	R	R
195	Bearings greased for life.	S	S	S	NA	NA	NA	NA	S	S	R	R	R	R
796	Grease nipples JIS B 1575 PT 1/8 Type A	NA	NA	NA	NA	NA	NA	NA	M	M	M	M	M	M
797	Stainless steel SPM Nipples	NA	NA	NA	R	R	R	R	M	M	M	M	M	M
798	Stainless steel grease nipples	NA	NA	NA	NA	NA	NA	NA	M	M	M	M	M	M
Branch standard designs														
071	Cooling Tower duty	NA	NA	NA	NA	NA	R	R	P	P	P	P	P	P
142	"Manilla connection".	NA	NA	NA	P	P	P	P	P	P	P	P	P	P
178	Stainless steel / acid proof bolts.	M	M	M	M	M	M	M	M	M	M	M	M	M
199	Extreme heavy duty design.	NA	NA	NA	NA	NA	NA	NA	M	M	M	M	M	M
209	Non-standard voltage or frequency, (special winding).	P	P	P	P	P	P	P	P	P	P	P	P	P
217	Cast iron D-end shield (on aluminum motor).	NA	NA	NA	M	M	M	M	M	M	M	M	M	S
232	Cast iron N-end shield (on aluminium motor).	NA	NA	NA	NA	NA	NA	NA	R	R	R	R	R	R
425	Corrosion protected stator and rotor core.	P	P	P	P	P	P	P	P	P	P	P	P	P
Cooling system														
053	Metal fan cover.	S	M	M	M	M	M	M	S	S	S	S	S	S
068	Light alloy metal fan	R	M	M	M	M	M	M	M	M	M	M	M	M
075	Cooling method IC418 (without fan).	R	R	R	P	P	P	P	M	M	M	M	M	M
183	Separate motor cooling (fan axial, N-end).	NA	M	M	M	M	M	P	M	M	M	M	M	M
189	Separate motor cooling, IP44, 400V, 50Hz (fan axial, N-end).	NA	NA	NA	NA	NA	NA	NA	M	M	M	M	M	M
Documentation														
141	Binding dimension drawing.	R	R	R	R	R	R	R	M	M	M	M	M	M

¹⁾ Certain variant codes cannot be used simultaneously.

S = Included as standard

P = New manufacture only

M = On modification of a stocked motor; or on new manufacture, the number of number per order may be limited.

R = On request

NA = Not applicable.

Code ¹⁾	Variant	Frame size												
		63	71	80	90	100	112	132	160	180	200	225	250	280
Drain holes														
065	Plugged existing drain holes.	M	M	M	M	M	M	M	M	M	M	M	M	M
Earthing Bolt														
067	External earthing bolt.	M	M	M	M	M	M	M	M	M	M	M	M	M
Hazardous Environments														
273	Ex e II acc. to ATEX directive 94/9/EC, temp. class T3.	P	P	P	P	P	P	P	P	NA	NA	NA	NA	NA
452	DIP/Ex tD acc. to ATEX directive 94/9/EC, T= 125 °C, cat. 3D, IP55	M	M	M	M	M	M	M	M	M	M	M	M	M
453	DIP/Ex tD acc. to ATEX directive 94/9/EC, T= 125 °C, cat. 2D, IP65	P	P	P	P	P	M	M	M	M	M	M	M	M
454	DIP/Ex tD acc. to ATEX directive 94/9/EC, T= 125 °C, cat. 3D, IP65	NA	NA	NA	NA	NA	NA	NA	M	M	M	M	M	M
456	Ex nA design, fulfilling IEC 60079-15, with certificate.	NA	NA	NA	NA	NA	NA	NA	M	M	M	M	M	NA
480	Ex nA II acc. to ATEX directive 94/9/EC, temp. class T3.	M	M	M	M	M	M	M	M	M	M	M	M	M
804	DIP/Ex tD, IEC 61241, T125 °C, IP55 (zone 22).	NA	NA	NA	NA	NA	NA	NA	M	M	M	M	M	NA
805	DIP/Ex tD, IEC 61241, T125 °C, IP65 (zone 21).	NA	NA	NA	NA	NA	NA	NA	M	M	M	M	M	NA
Heating elements														
450	Heating element, 100-120V.	M	M	M	M	M	M	M	M	M	M	M	M	M
451	Heating element, 200-240V.	M	M	M	M	M	M	M	M	M	M	M	M	M
Insulation system														
014	Winding insulation class H.	R	R	R	P	P	P	P	P	P	P	P	P	P
405	Special winding insulation for frequency converter supply.	R	R	R	P	P	P	P	P	P	P	P	P	P
406	Winding for supply >690<=1000 Volts.	NA	NA	NA	NA	NA	NA	NA	R	R	P	P	P	P
Mounting arrangements														
007	IM 3001 flange mounted, IEC flange, from IM 1001 (B5 from B3).	NA	NA	NA	NA	NA	NA	NA	NA	NA	M	M	M	M
008	IM 2101 foot/flange mounted, IEC flange, from IM 1001 (B34 from B3).	M	M	M	M	M	M	M	M	NA	NA	NA	NA	NA
009	IM 2001 foot/flange mounted, IEC flange, from IM 1001 (B35 from B3).	M	M	M	M	M	M	M	M	M	M	M	M	M
047	IM 3601 flange mounted, IEC flange, from IM 3001 (B14 from B5).	M	M	M	M	M	M	M	M	NA	NA	NA	NA	NA
048	IM 3001 flange mounted, IEC flange, from IM 3601 (B5 from B14).	M	M	M	M	M	M	M	NA	NA	NA	NA	NA	NA
066	Modified for non-standard mounting position (please specify IM xxxx), (must be ordered for all mounting arrangements excluding IM B3 (1001), IM B5 (3001), IM B35 (2001), B34 (2101) & B14 (3601).	M	M	M	M	M	M	M	M	M	M	M	M	M
200	Flange ring holder.	NA	M	M	M	M	M	M	R	R	R	R	R	R
218	Flange ring FT 85.	NA	M	M	M	NA	NA	NA	NA	NA	NA	NA	NA	NA
219	Flange ring FT 100.	NA	M	M	M	NA	NA	NA	NA	NA	NA	NA	NA	NA
220	Flange ring FF 100.	NA	M	M	M	NA	NA	NA	NA	NA	NA	NA	NA	NA

¹⁾ Certain variant codes cannot be used simultaneously.

S = Included as standard
P = New manufacture only
M = On modification of a stocked motor; or on new manufacture, the number of number per order may be limited.
R = On request
NA = Not applicable.

Code ¹⁾	Variant	Frame size												
		63	71	80	90	100	112	132	160	180	200	225	250	280
223	Flange ring FF 115.	NA	M	M	M	NA	NA	NA	NA	NA	NA	NA	NA	NA
224	Flange ring FT 115.	NA	M	M	M	M	M	NA	NA	NA	NA	NA	NA	NA
226	Flange ring FF 130.	NA	M	M	M	M	M	NA	NA	NA	NA	NA	NA	NA
227	Flange ring FT 130.	NA	M	M	M	M	M	NA	NA	NA	NA	NA	NA	NA
229	Flange FT 130.	NA	NA	NA	NA	M	M	NA	NA	NA	NA	NA	NA	NA
233	Flange ring FF 165.	NA	M	M	M	M	M	NA	NA	NA	NA	NA	NA	NA
234	Flange ring FT 165.	NA	M	M	M	M	M	NA	NA	NA	NA	NA	NA	NA
235	Flange FF 165.	NA	NA	NA	M	NA	NA	NA	NA	NA	NA	NA	NA	NA
243	Flange ring FF 215.	NA	NA	NA	NA	M	M	M	NA	NA	NA	NA	NA	NA
244	Flange ring FT 215.	NA	NA	NA	NA	M	M	M	NA	NA	NA	NA	NA	NA
245	Flange FF 215.	NA	NA	NA	NA	M	M	NA	NA	NA	NA	NA	NA	NA
255	Flange FF 265.	NA	NA	NA	NA	NA	NA	M	NA	NA	NA	NA	NA	NA
260	Flange FT 115.	NA	NA	NA	M	NA	NA	NA	NA	NA	NA	NA	NA	NA
306	IM 1001 foot mounted, from IM 3601 (B3 from B14).	M	M	M	M	M	M	M	NA	NA	NA	NA	NA	NA
307	IM 2101 foot/flange mounted, IEC flange, from IM 3601 (B34 from B14).	M	M	M	M	M	M	M	NA	NA	NA	NA	NA	NA
308	IM 2001 foot/flange mounted, IEC flange, from IM 3601 (B35 from B14).	M	M	M	M	M	M	M	NA	NA	NA	NA	NA	NA
309	IM 1001 foot mounted, from IM 3001 (B3 from B5).	M	M	M	M	M	M	M	NA	NA	NA	NA	NA	NA
310	IM 2101 foot/flange mounted, IEC flange, from IM 3001 (B34 from B5).	M	M	M	M	M	M	M	NA	NA	NA	NA	NA	NA
311	IM 2001 foot/flange mounted, IEC flange, from IM 3001 (B35 from B5).	M	M	M	M	M	M	M	NA	NA	NA	NA	NA	NA
312	IM 1001 foot mounted, from IM 2101 (B3 from B34).	M	M	M	M	M	M	M	NA	NA	NA	NA	NA	NA
315	IM 2001 foot/flange mounted, IEC flange, from IM 2101 (B35 from B34).	M	M	M	M	M	M	M	NA	NA	NA	NA	NA	NA
316	IM 1001 foot mounted, from IM 2001 (B3 from B35).	M	M	M	M	M	M	M	NA	NA	NA	NA	NA	NA
319	IM 2101 foot/flange mounted, IEC flange, from IM 2001 (B34 from B35).	M	M	M	M	M	M	M	NA	NA	NA	NA	NA	NA
Painting														
114	Special paint colour, standard grade.	M	P	P	M	M	M	M	M	M	M	M	M	M
168	Primer paint only.	NA	NA	NA	P	P	P	P	NA	NA	NA	NA	NA	NA
Protection														
005	Metal protective roof, vertical motor, shaft down.	M	M	M	M	M	M	M	M	M	M	M	M	M
072	Radial seal at D-end.	M	M	M	M	M	M	M	M	M	M	M	M	M
073	Sealed against oil at D-end.	NA	NA	NA	NA	NA	NA	NA	NA	NA	NA	NA	M	NA
158	Degree of protection IP65.	M	M	M	M	M	M	M	M	M	M	M	M	M
211	Weather protected, IP xx W.	NA	NA	NA	P	P	P	M	M	M	M	M	M	M
403	Degree of protection IP56.	M	M	M	M	M	M	M	M	M	M	M	M	M
404	Degree of protection IP56, without fan and fan cover.	NA	NA	NA	P	P	P	P	NA	NA	NA	NA	NA	NA
784	Gamma-seal at D-end.	NA	NA	NA	M	M	M	M	M	M	M	M	M	M
Rating & instruction plates														
002	Restamping voltage, frequency and output, continuous duty.	M	M	M	M	M	M	M	M	M	M	M	M	M

¹⁾ Certain variant codes cannot be used simultaneously.

S = Included as standard

P = New manufacture only

M = On modification of a stocked motor; or on new manufacture, the number of number per order may be limited.

R = On request

NA = Not applicable.

Code ¹⁾	Variant	Frame size												
		63	71	80	90	100	112	132	160	180	200	225	250	280
003	Individual serial number.	M	M	M	M	M	M	M	M	M	M	M	M	M
004	Additional text on std rating plate (max 12 digits on free text line).	NA	NA	NA	M	M	M	M	M	M	M	M	M	M
095	Restamping output (maintained voltage, frequency), intermittent duty.	M	M	M	M	M	M	M	M	M	M	M	M	M
098	Stainless rating plate.	M	M	M	M	M	M	M	M	M	M	M	M	M
135	Mounting of additional identification plate, stainless.	M	M	M	M	M	M	M	R	R	R	R	R	R
138	Mounting of additional identification plate, aluminium.	M	M	M	M	M	M	M	M	M	M	M	M	M
139	Additional identification plate delivered loose.	M	M	M	M	M	M	M	M	M	M	M	M	M
160	Additional rating plate affixed.	P	P	P	M	M	M	M	M	M	M	M	M	M
161	Additional rating plate delivered loose.	M	M	M	M	M	M	M	M	M	M	M	M	M
163	Frequency converter rating plate. Rating data according to quotation.	R	R	R	R	R	R	R	M	M	M	M	M	M
198	Aluminum rating plate.	S	S	S	S	S	S	M	S	S	S	S	S	S
Shaft & rotor														
069	Two shaft extensions as per basic catalogue.	NA	NA	NA	P	P	P	P	P	P	P	P	P	P
070	One or two special shaft extensions, standard shaft material.	NA	NA	NA	P	P	P	P	R	R	R	R	R	R
131	Motor delivered with half key (Key not exceeding shaft diameter)	NA	NA	NA	M	M	M	M	M	M	M	M	M	M
165	Shaft extension with open key-way.	NA	NA	NA	P	P	P	P	P	P	P	P	P	P
410	Stainless steel shaft (standard or non-standard design).	NA	NA	NA	P	P	P	P	R	R	R	R	R	R
Standards and Regulations														
010	Fulfilling CSA Safety Certificate.	NA	NA	NA	P	P	P	NA	M	M	M	M	M	M
011	Fulfilling CSA Energy Efficiency Verification (code 010 included).	NA	NA	NA	NA	NA	NA	NA	M	M	M	M	M	M
778	GOST Export/Import Certificate (Russia).	NA	NA	NA	M	M	M	M	M	M	M	M	M	M
779	SASO Export/Import Certificate (Saudi Arabia)	NA	NA	NA	NA	NA	NA	NA	M	M	M	M	M	M
Stator winding temperature sensors														
121	Bimetal detectors, break type (NCC), (3 in series), 130°C, in stator winding.	M	M	M	M	M	M	M	M	M	M	M	M	M
122	Bimetal detectors, break type (NCC), (3 in series), 150°C, in stator winding.	M	M	M	M	M	M	M	M	M	M	M	M	M
123	Bimetal detectors, break type (NCC), (3 in series), 170°C, in stator winding.	M	M	M	M	M	M	M	M	M	M	M	M	M
124	Bimetal detectors, break type (NCC), (3 in series), 140°C, in stator winding.	NA	NA	NA	NA	NA	NA	NA	M	M	M	M	M	M
125	Bimetal detectors, break type (NCC), (2x3 in series), 150°C, in stator winding.	NA	NA	NA	M	M	M	M	M	M	M	M	M	M
127	Bimetal detectors, break type (NCC), (3 in series, 130°C & 3 in series, 150°C), in stator winding.	NA	NA	NA	M	M	M	M	M	M	M	M	M	M
321	Bimetal detectors, closing type (NO), (3 in parallel), 130°C, in stator winding.	M	M	M	M	M	M	M	R	R	R	R	R	R
322	Bimetal detectors, closing type (NO), (3 in parallel), 150°C, in stator winding.	M	M	M	M	M	M	M	R	R	R	R	R	R
323	Bimetal detectors, closing type (NO), (3 in parallel), 170°C, in stator winding.	NA	NA	NA	P	P	P	P	R	R	R	R	R	R

¹⁾ Certain variant codes cannot be used simultaneously.

S = Included as standard
P = New manufacture only
M = On modification of a stocked motor; or on new manufacture,
the number of number per order may be limited.
R = On request
NA = Not applicable.

Code ¹⁾	Variant	Frame size												
		63	71	80	90	100	112	132	160	180	200	225	250	280
325	Bimetal detectors, closing type (NO), (2x3 in parallel), 150°C, in stator winding.	NA	NA	NA	P	P	M	M	R	R	R	R	R	R
327	Bimetal detectors, closing type (NO), (3 in parallel, 130°C & 3 in parallel, 150°C), in stator winding.	NA	NA	NA	P	P	M	M	R	R	R	R	R	R
435	PTC - thermistors (3 in series), 130°C, in stator winding.	M	M	M	M	M	M	M	M	M	M	M	M	M
436	PTC - thermistors (3 in series), 150°C, in stator winding.	M	M	M	M	M	M	M	-	-	S	S	S	S
437	PTC - thermistors (3 in series), 170°C, in stator winding.	M	M	M	P	P	M	M	M	M	M	M	M	M
439	PTC - thermistors (2x3 in series), 150°C, in stator winding.	NA	NA	NA	M	M	M	M	M	M	M	M	M	M
440	PTC - thermistors (3 in series, 110°C & 3 in series, 130°C), in stator winding.	NA	NA	NA	P	P	P	P	R	R	R	R	R	R
441	PTC - thermistors (3 in series, 130°C & 3 in series, 150°C), in stator winding.	NA	NA	NA	M	M	M	M	M	M	M	M	M	M
442	PTC - thermistors (3 in series, 150°C & 3 in series, 170°C), in stator winding.	NA	NA	NA	P	P	M	M	M	M	M	M	M	M
445	Pt-100 2-wire in stator winding, 1 per phase	NA	NA	NA	R	R	M	M	M	M	M	M	M	M
446	Pt-100 2-wire in stator winding, 2 per phase	NA	NA	NA	R	R	R	R	M	M	M	M	M	M
Terminal box														
015	Motor supplied in D connection.	M	M	M	M	M	M	M	M	M	M	M	M	M
016	9 terminals in terminal box	NA	NA	NA	P	P	P	P	NA	NA	NA	NA	NA	NA
017	Motor supplied in Y connection.	M	M	M	P	P	NA	NA	M	M	M	M	M	M
019	Larger than standard terminal box.	NA	NA	NA	NA	NA	NA	NA	M	M	M	M	M	NA
021	Terminal box LHS (seen from D-end).	NA	NA	NA	NA	NA	NA	NA	NA	NA	P	P	P	P
022	Cable entry LHS (seen from D-end).	NA	NA	NA	NA	NA	NA	NA	S	S	R	R	R	R
136	Extended cable connection, standard terminal box.	NA	NA	NA	P	P	P	P	R	R	R	R	R	R
137	Extended cable connection, low terminal box, "Flying leads".	P	P	P	P	P	P	P	R	R	R	R	R	R
180	Terminal box RHS (seen from D-end).	NA	NA	NA	NA	NA	NA	NA	M	M	M	M	M	P
230	Standard metal cable glands.	M	M	M	M	M	M	M	M	M	M	M	M	M
375	Standard plastic cable gland	M	M	M	M	M	M	M	NA	NA	NA	NA	NA	NA
376	Two standard plastic cable glands	M	M	M	M	M	M	M	NA	NA	NA	NA	NA	NA
400	4 x 90 degr turnable terminal box.	NA	NA	NA	NA	NA	NA	NA	R	R	NA	NA	NA	NA
402	Terminal box adapted for AI cables.	NA	NA	NA	NA	NA	NA	NA	NA	NA	P	P	P	P
413	Extended cable connection, no terminal box.	NA	NA	NA	NA	NA	NA	NA	NA	NA	R	R	R	R
418	Separate terminal box for auxiliaries, standard material.	NA	NA	NA	NA	R	R	R	M	M	M	M	M	M
467	Lower than standard terminal box and rubber extended cable. Cable length 2m.	NA	NA	NA	NA	NA	NA	NA	P	P	P	P	P	P
729	Aluminum non-drilled flange for cable glands	NA	NA	NA	NA	NA	NA	NA	NA	NA	M	M	M	M
731	Two standard metal cable glands.	M	M	M	M	M	M	M	M	M	M	M	M	M
739	Prepared for metric cable glands according to DIN 42925, draft aug. 1999.	NA	NA	NA	NA	NA	NA	NA	S	S	M	M	M	P
740	Prepared for PG cable glands.	NA	NA	NA	NA	NA	NA	NA	M	M	M	M	M	M
Testing														
140	Test confirmation.	M	M	M	M	M	M	M	M	M	M	M	M	M

¹⁾ Certain variant codes cannot be used simultaneously.

S = Included as standard

P = New manufacture only

M = On modification of a stocked motor; or on new manufacture, the number of number per order may be limited.

R = On request

NA = Not applicable.

Code ¹⁾	Variant	Frame size													
		63	71	80	90	100	112	132	160	180	200	225	250	280	
145	Type test report from a catalogue motor, 400V 50Hz.	M	M	M	M	M	M	M	M	M	M	M	M	M	
146	Type test with report for one motor from specific delivery batch.	M	M	M	M	M	M	M	M	M	M	M	M	M	
147	Type test with report for motor from specific delivery batch, customer witnessed.	M	M	M	M	M	M	M	M	M	M	M	M	M	
148	Routine test report.	M	M	M	M	M	M	M	M	M	M	M	M	M	
153	Reduced test for classification society.	M	M	M	M	M	M	M	M	M	M	M	M	M	
221	Type test and multi-point load test with report for one motor from specific delivery batch.	M	M	M	M	M	M	M	M	M	M	M	M	M	
222	Torque/speed curve, type test and multi-point load test with report for one motor from specific delivery batch.	NA	NA	NA	P	P	P	P	M	M	M	M	M	M	
760	Vibration level test	M	M	M	P	P	P	P	M	M	M	M	M	M	
762	Noise level test for one motor from specific delivery batch.	M	M	M	P	P	P	P	M	M	M	M	M	M	
763	Noise spectrum test for one motor from specific delivery batch.	NA	NA	NA	P	P	NA	NA	R	R	R	R	R	R	
Variable speed drives															
470	Prepared for hollow shaft pulse tacho (L&L equivalent).	R	R	R	R	R	R	R	M	M	M	M	M	M	
472	1024 pulse tacho (L&L 861007455-1024).	R	R	R	R	R	R	P	M	M	M	M	M	M	
473	2048 pulse tacho (L&L 861007455-2048).	R	R	R	R	R	R	R	M	M	M	M	M	M	
474	Separate motor cooling (fan axial, N-end) and prepared for hollow shaft tacho (L&L equivalent).	R	R	R	R	R	R	R	M	M	M	M	M	M	
476	Separate motor cooling (fan axial, N-end) and 1024 pulse tacho (L&L 861007455-1024).	R	R	R	R	R	R	P	M	M	M	M	M	M	
477	Separate motor cooling (fan axial, N-end) and 2048 pulse tacho (L&L 861007455-2048).	R	R	R	R	R	R	R	M	M	M	M	M	M	
570	Prepared for hollow shaft pulse tacho (L&L 503).	R	R	R	NA	NA	R	R	M	M	M	M	M	M	
572	1024 pulse tacho (L&L 503).	R	R	R	NA	NA	NA	NA	M	M	M	M	M	M	
573	2048 pulse tacho (L&L 503).				NA	NA	NA	NA	M	M	M	M	M	M	
574	Separate motor cooling (fan axial, N-end) and prepared for hollow shaft tacho (L&L 503).	R	R	R	NA	NA	NA	NA	M	M	M	M	M	M	
576	Separate motor cooling (fan axial, N-end) and 1024 pulse tacho (L&L 503).	R	R	R	NA	NA	NA	NA	M	M	M	M	M	M	
577	Separate motor cooling (fan axial, N-end) and 2048 pulse tacho (L&L 503).	R	R	R	NA	NA	NA	NA	M	M	M	M	M	M	
578	Separate motor cooling, IP44, 400V, 50Hz (fan axial, N-end) and prepared for hollow shaft tacho (L&L 503).	NA	NA	NA	NA	NA	NA	NA	M	M	M	M	M	M	
580	Separate motor cooling, IP44, 400V, 50Hz (fan axial, N-end) and 1024 pulse tacho (L&L 503).	NA	NA	NA	NA	NA	NA	NA	M	M	M	M	M	M	
581	Separate motor cooling, IP44, 400V, 50Hz (fan axial, N-end) and 2048 pulse tacho (L&L 503).	NA	NA	NA	NA	NA	R	R	M	M	M	M	M	M	

¹⁾ Certain variant codes cannot be used simultaneously.

S = Included as standard
P = New manufacture only
M = On modification of a stocked motor; or on new manufacture, the number of number per order may be limited.
R = On request
NA = Not applicable.

Code ¹⁾	Variant	Frame size													
		63	71	80	90	100	112	132	160	180	200	225	250	280	
661	1024 Pulse tacho mounted, Hohner series 59, 11-30V	NA	R	R	P	P	P	P	NA	NA	NA	NA	NA	NA	
662	2048 Pulse tacho mounted, Hohner series 59, 11-30V	NA	R	R	P	P	P	P	NA	NA	NA	NA	NA	NA	
701	Insulated bearing at N-end.	NA	NA	NA	NA	NA	NA	NA	NA	NA	M	M	M	M	
704	EMC cable gland.	NA	NA	NA	M	M	M	M	M	M	M	M	M	M	
Y/Δ starting															
117	Terminals for Y/Δ start at both speeds (two speed windings).	NA	NA	NA	P	P	P	P	NA	NA	NA	NA	NA	P	
118	Terminals for Y/Δ start at high speed (two speed windings).	P	P	P	P	P	P	P	NA	NA	NA	NA	NA	NA	

¹⁾ Certain variant codes cannot be used simultaneously.

S = Included as standard

P = New manufacture only

M = On modification of a stocked motor; or on new manufacture, the number of number per order may be limited.

R = On request

NA = Not applicable.

Non-sparking motors, cast iron frame

Dimension drawings

Foot-mounted motor IM 1001, IM B3

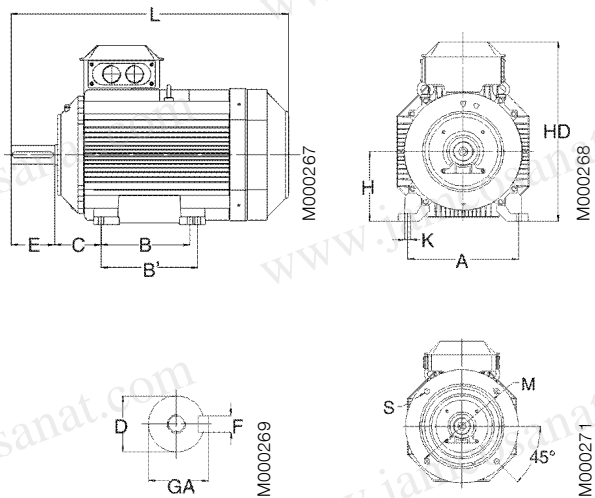

Sizes 71-200

Flange-mounted motor IM 3001, IM B5

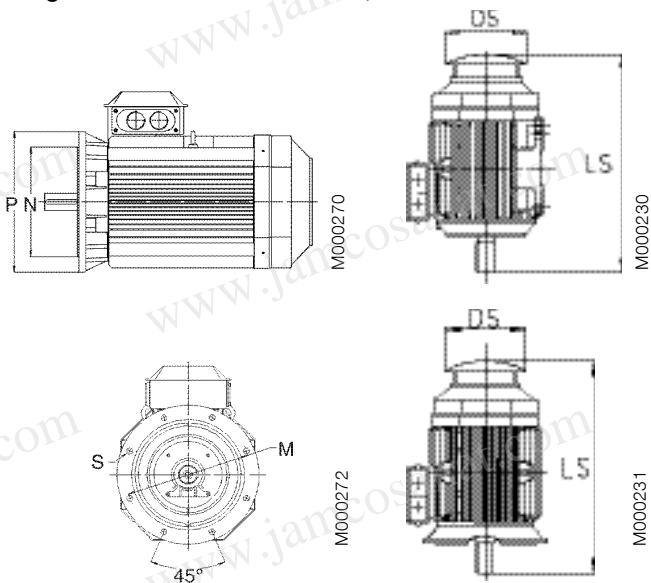

Sizes 225-400

Protective roof,
variant code 005

Motor size	IM 1001, IM B3 AND IM 3001, IM B5										IM 1001, IM B3					IM 3001, IM B5					Protective roof				
	D poles		GA poles		F poles		E poles		L max poles		O	A	B	B'	C	HD	K	H	M	N	P	S	DS	LS poles	
	2	4-8	2	4-8	2	4-8	2	4-8	2	4-8	2	4-8	2	4-8	2	4-8	2	4-8	2	4-8	2	4-8	2	4-8	
80	19	19	21.5	21.5	6	6	40	40	340	340	20	125	100	125	50	235	10	80	165	130	200	12	160	360	360
90	24	24	27	27	8	8	50	50	405	405	20	140	100	125	56	260	10	90	165	130	200	12	180	430	430
100	28	28	31	31	8	8	60	60	480	480	25	160	140	-	63	280	12	100	215	180	250	14.5	195	505	505
112	28	28	31	31	8	8	60	60	480	480	25	190	140	-	70	295	12	112	215	180	250	14.5	195	505	505
132	38	38	41	41	10	10	80	80	560	560	30	216	140	178	89	340	12	132	265	230	300	14.5	260	590	590
160	42	42	45	45	12	12	110	110	808	808	45	254	210	254	108	499	14.5	160	300	250	350	18.5	328	756	756
180	48	48	51.5	51.5	14	14	110	110	826	826	50	279	241	279	121	539	14.5	180	300	250	350	18.5	359	756	756
200	55	55	59	59	16	16	110	110	774	774	70	318	267	305	133	536	18.5	200	350	300	400	18.5	414	844	844
225	55	60	59	64	16	18	110	140	841	871	80	356	286	311	149	583	18.5	225	400	350	450	18.5	462	921	951
250	60	65	64	69	18	18	140	140	875	875	90	406	311	349	168	646	24	250	500	450	550	18.5	506	965	965
280	65	75	69	79.5	18	20	140	140	1088	1088	100	457	368	419	190	759	24	280	500	450	550	18	555	1190	1190
315 SM	65	80	69	85	18	22	140	170	1174	1204	115	508	406	457	216	852	30	315	600	550	660	23	624	1290	1320
315 ML	65	90	69	95	18	25	140	170	1285	1315	115	508	457	508	216	852	30	315	600	550	660	23	624	1401	1431
355 SM	70	100	62.5	90	20	28	140	210	1409	1479	130	610	500	560	254	958	35	355	740	680	800	23	720	1476	1546
355 ML	70	100	62.5	90	20	28	140	210	1514	1584	130	610	560	630	254	958	35	355	740	680	800	23	720	1528	1703
355 LK	70	100	62.5	90	20	28	140	210	1764	1834	130	610	710	900	254	958	35	355	740	680	800	23	720	1633	1703
400 L	80	110	85	126	22	28	170	210	1851	1891	150	710	900	1000	224	1045	35	400	940	880	1000	28	810	1860	1900
400 LK	80	100	85	106	22	28	170	210	1851	1891	150	686	710	800	280	1045	35	400	740	680	800	24	810	1860	1900
450	80	120	85	127	22	32	170	210	2147	2187	180	800	1000	1120	250	1169	42	450	1080	1000	1150	28	On request		

IM 3601, IM B14 - Available flange alternatives, see also variant codes

Flange size	Variant code	Flange dimensions				Motor sizes 80-132					S = Standard M = Modification NA = Not possible
		P	M	N	S	80	90	100	112	132	
FF100	258	120	100	80	M6	S	NA	NA	NA	NA	S = Standard
FF115	260	140	115	95	M8	M	S	NA	NA	NA	M = Modification
FF130	229	160	130	110	M8	M	M	S	S	NA	NA = Not possible
FF165	236	200	165	130	M10	NA	NA	NA	NA	S	
FF215	246	250	215	180	M12	NA	NA	M	M	M	
FF265	256	300	265	230	M12	NA	NA	NA	NA	M	
FT100	257	120	100	80	M7	S	M	NA	NA	NA	
FT115	259	140	115	95	M10	M	S	NA	NA	NA	
FT130	228	160	130	110	M10	M	M	S	S	NA	
FT165	235	200	165	130	M12	M	M	M	M	S	
FT215	245	250	215	180	M14.5	NA	NA	M	M	M	
FT265	255	300	265	230	M14.5	NA	NA	NA	NA	M	

Tolerances:

- A, B ± 0,8
- D, DA ISO k6 < Ø 50mm
ISO m6 > Ø 50mm
- F, FA ISO h9
- H -0.5
- N ISO j6
- C, CA ± 0.8

Above table gives the main dimensions in mm. For detailed drawings please see our web-pages www.abb.com/motors&generators or contact ABB.

Non-sparking motors, aluminum frame

Dimension drawings

Foot-mounted motor IM 1001, IM B3

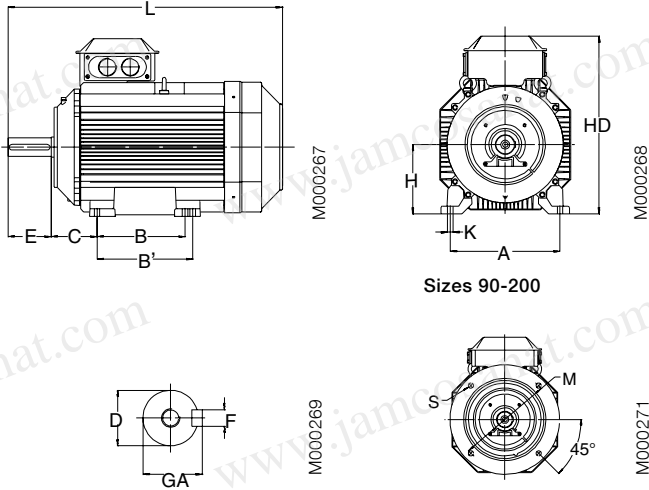

Flange-mounted motor IM 3001, IM B5

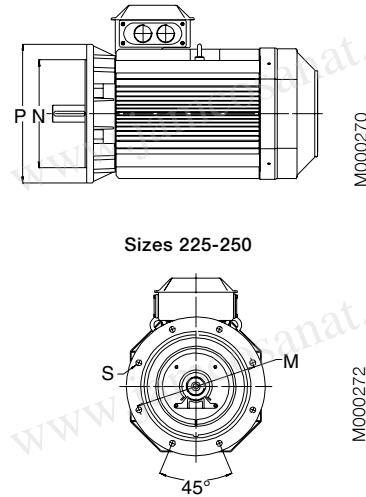

Motor size	IM 1001, IM B3 AND IM 3001, IM B5										IM 1001, IM B3				IM 3001, IM B5							
	D poles		GA poles		F poles		E poles		L max poles		A	B	B'	C	HD	K	H	M	N	P	S	
	2	4-8	2	4-8	2	4-8	2	4-8	2	4-8												
M3AAN 63	11	11	12.5	12.5	4	4	23	23	214	214	100	80	-	40	151	7	63	100	80	120	7	
71	14	14	16	16	5	5	30	30	240	240	112	90	-	45	180	7	71	130	130	160	10	
80	19	19	21.5	21.5	6	6	40	40	265.5	265.5	125	100	-	50	193.5	10	80	165	130	200	12	
M3AAN 90 S	24	24	27	27	8	8	50	50	282	282	140	100	-	56	212	10	90	165	130	200	12	
90 L	24	24	27	27	8	8	50	50	307	307	140	125	-	56	212	10	90	165	130	200	12	
100	28	28	31	31	8	8	60	60	349	349	160	140	-	63	236	12	100	215	180	250	15	
112	28	28	31	31	8	8	60	60	361	361	190	140	-	70	258	12	112	215	180	250	14.5	
132	38	41	41	41	10	10	80	80	447	447	216	140	178	89	295.5	12	132	265	230	300	14.5	
M3AA 160	M/MA 2-8, L 2-6, LB 2-4	42	42	45	45	12	12	110	110	602.5	602.5	254	210	254	108	370	15	160	300	250	350	19
160	L 8, LB 6-8	42	42	45	45	12	12	110	110	643.5	643.5	254	210	254	108	370	15	160	300	250	350	19
180	M 2-4, L 6-8, LB 2	48	48	51.5	51.5	14	14	110	110	680	680	279	241	279	121	405	15	180	300	250	350	19
180	L 4, LB 4-8	48	48	51.5	51.5	14	14	110	110	700.5	700.5	279	241	279	121	405	15	180	300	250	350	19
200	MLD-2,-C 4	55	55	59	59	16	16	110	110	814	814	318	267	305	133	533	18	200	350	300	400	19
200	all exc. above	55	55	59	59	16	16	110	110	774	774	318	267	305	133	533	18	200	350	300	400	19
225	SMB,-C	55	55	59	59	16	16	110	110	836	836	356	286	311	149	578	18	225	400	350	450	19
225	SMA,-B,-C	60	60	64	64	18	18	140	140	866	891	356	286	311	149	578	18	225	400	350	450	19
225	SMD	55	60	59	64	16	18	110	140	861	891	356	286	311	149	578	18	225	400	350	450	19
250	SMA,-B	60	65	64	69	18	18	140	140	875	875	406	311	349	168	626	22	250	500	450	550	19
250	SMC	60	65	64	69	18	18	140	140	900	900	406	311	349	168	626	22	250	500	450	550	19
280	SMA	65	75	69	79.5	18	20	140	140	875	875	457	368	419	190	656	24	280	500	450	550	19
280	SMB	65	75	69	79.5	18	20	140	140	900	900	457	368	419	190	656	24	280	500	450	550	19
280	SMB	65	75	69	79.5	18	20	140	140	900	900	457	368	419	190	656	24	280	500	450	550	19

IM 3601, IM B14

Motor size	M	N	P	S	T
63	65	50	80	M5	2.5
71	85	70	105	M6	3
80	100	80	120	M6	3
90	115	95	140	M8	3
100	130	100	160	M8	3.5
112	130	110	160	M8	3.5
132	165	130	200	M10	3.5

Tolerances:

A, B	± 0,8
D, DA	ISO k6 < Ø 50mm ISO m6 > Ø 50mm
F, FA	ISO h9
H	-0.5
N	ISO j6
C, CA	± 0.8

Above table gives the main dimensions in mm. For detailed drawings please see our web-pages www.abb.com/motors&generators or contact ABB.

Non-sparking motor construction

Typical exploded view of cast iron motors, frame size 315

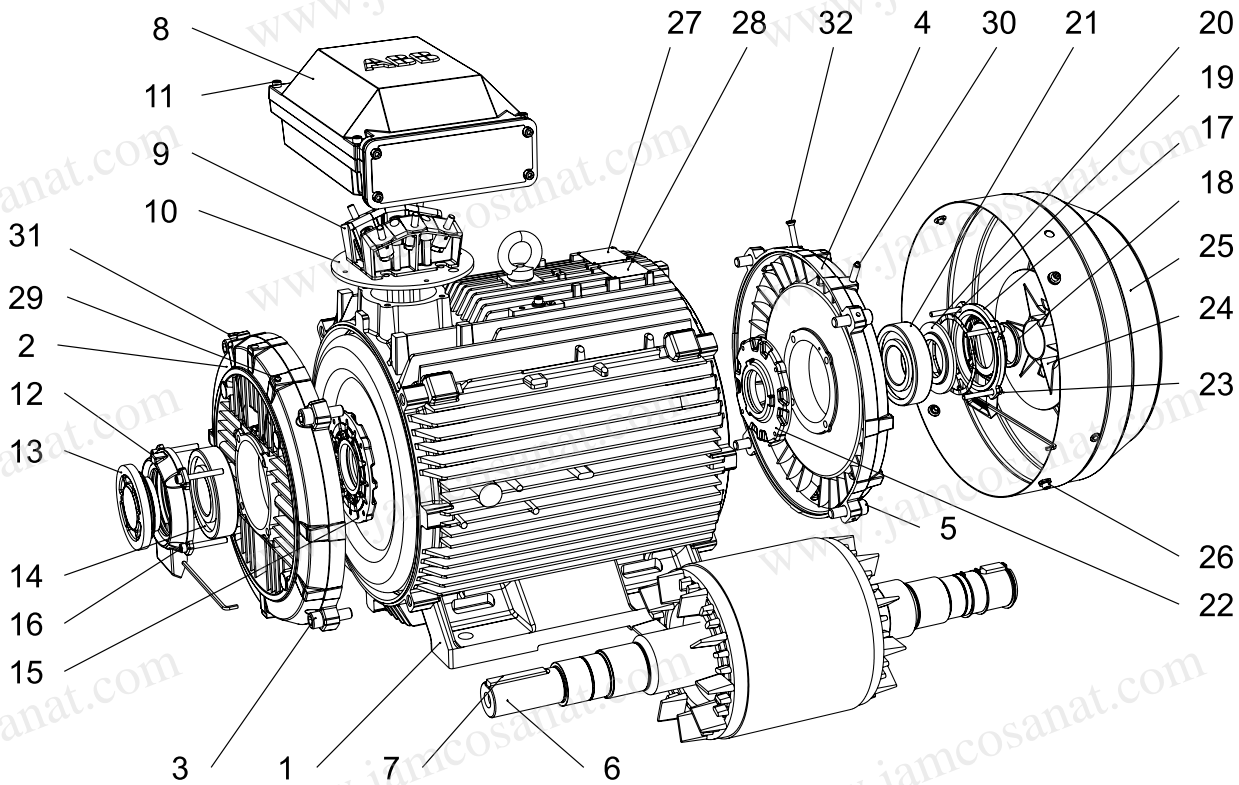

M000220

- | | | | |
|----|--|----|---------------------------------|
| 1 | Stator frame | 17 | Outer bearing cover, N-end |
| 2 | Endshield, D-end | 18 | Seal, N-end |
| 3 | Screws for endshield, D-end | 19 | Wave spring |
| 4 | Endshield, N-end | 20 | Valve disc, N-end |
| 5 | Screws for endshield, N-end | 21 | Bearing, N-end |
| 6 | Rotor with shaft | 22 | Inner bearing cover, N-end |
| 7 | Key, D-end | 23 | Screws for bearing cover, N-end |
| 8 | Terminal box | 24 | Fan |
| 9 | Terminal board | 25 | Fan cover |
| 10 | Intermediate flange | 26 | Screws for fan cover |
| 11 | Screws for terminal box cover | 27 | Rating plate |
| 12 | Outer bearing cover, D-end | 28 | Regreasing plate |
| 13 | Valve disc with labyrinth seal, D-end;
standard in 2-pole motors (V-ring in 4-8 pole) | 29 | Grease nipple, D-end |
| 14 | Bearing, D-end | 30 | Grease nipple, N-end |
| 15 | Inner bearing cover, D-end | 31 | SPM nipple, D-end |
| 16 | Screws for bearing cover, D-end | 32 | SPM nipple, N-end |

Certificate examples

IECEx Certificate of Conformity

**INTERNATIONAL ELECTROTECHNICAL COMMISSION
IEC Certification Scheme for Explosive Atmospheres**
for rules and details of the IECEx Scheme visit www.iecex.com

Certificate No.: IECEx LC1 07 0001 Issue No.: 0 History:

Status: Current

Date of Issue: 2007-01-12 Page 1 of 3

Applicant: **ABB Oy, Motors**
Strombergin Puistotie 5A
P.O. box 633
65101 VAASA
Finland

Electrical Apparatus: **M3GP90-450 & M3LP400-450 series, 13 cage induction motor types**
Optional accessory:

Type of Protection: **Non sparking Ex nA and dust protection Ex ID.**

Marking: **Ex nA II T3, Ex ID A21/A22 T12S**

Approved for issue on behalf of the IECEx
Certification Body: **Maic GILLAUX**
Position: **Ex Certification Manager**

Signature (for printed version): *[Signature]*
Date: **12 JAN. 2007**

1 This certificate and schedule may only be reproduced in full.
2 This certificate is not transferable and remains the property of the issuing body.
3 The Status and authenticity of this certificate may be verified by visiting the Official IECEx Website.

Certificate issued by:
Laboratoire Central des Industries Electriques (LCIE)
33 Avenue du General Leclerc
FR-92266 Fontenay-aux-Roses
France

M000730

LCIE

1 ATTESTATION D'EXAMEN CE DE TYPE

2 Appareil ou système de protection destiné à être utilisé en atmosphères explosibles (Directive 94/9/CE)

3 Numéro de l'attestation d'examen CE de type
LCIE 09 ATEX 3016

4 Appareil ou système de protection :
Moteur asynchrone
Type : **M3GP160 ... M3GP180 ... (Génération H)**

5 Demandeur : **ABB Oy Motors**
Adresse : **Strombergin Puistotie 5A
FIN - 65101 VAASA - Finland**

6 Fabricant : **ABB Oy Motors**
Adresse : **Strombergin Puistotie 5A
FIN - 65101 VAASA - Finland**

7 Cet appareil ou système de protection et ses variantes éventuelles acceptées sont décrits dans l'annexe de la présente attestation et dans les documents descriptifs cités en référence.

8 Le LCIE, organisme notifié sous la référence 0081 conformément à l'article 9 de la directive 94/9/CE du Parlement européen et du Conseil du 23 mars 1994, certifie que cet appareil ou système de protection est conforme aux exigences essentielles de sécurité et de santé pour la conception et la construction d'appareils et de systèmes de protection destinés à être utilisés en atmosphères explosibles, données dans l'annexe II de la directive. Les résultats des vérifications et essais figurent dans le rapport confidentiel N° 90248-581521.

9 Le respect des exigences essentielles de sécurité et de santé est assuré par la conformité à :
- EN 61241-0 (2006)
- EN 61241-1 (2004)

10 Le signe X lorsqu'il est placé à la suite du numéro de l'attestation, indique que cet appareil ou système de protection est soumis aux conditions spéciales pour une utilisation sûre, mentionnées dans l'annexe II de la présente attestation.

11 Cette attestation d'examen CE de type concerne uniquement la conception et la construction de l'appareil ou du système de protection spécifié, conformément à l'annexe III de la directive 94/9/CE. Des exigences supplémentaires de la directive sont applicables pour la fabrication et la fourniture de l'appareil ou du système de protection. Ces dernières ne sont pas couvertes par la présente attestation.

12 Le marquage de l'appareil ou du système de protection doit comporter les informations détaillées au point 15.
Fontenay-aux-Roses, le 16 mars 2009

1 EC TYPE EXAMINATION CERTIFICATE

2 Equipment or protective system intended for use in potentially explosive atmospheres (Directive 94/9/EC)

3 EC type examination certificate number
LCIE 09 ATEX 3016

4 Equipment or protective system :
Asynchronous motor
Type : **M3GP160 ... M3GP180 ... (Generation H)**

5 Applicant : **ABB Oy Motors**
Address : **Strombergin Puistotie 5A
FIN - 65101 VAASA - Finland**

6 Manufacturer : **ABB Oy Motors**
Address : **Strombergin Puistotie 5A
FIN - 65101 VAASA - Finland**

7 This equipment or protective system and any acceptable variation thereto are specified in the schedule to this certificate and the documents therein referred to.

8 LCIE, notified body number 0081 in accordance with article 9 of the Directive 94/9/EC of the European Parliament and the Council of 23 March 1994, certifies that this equipment or protective system has been found to comply with the essential Health and Safety Requirements relating to the design and construction of equipment and protective systems intended for use in potentially explosive atmospheres, given in Annex II to the Directive. The examination and test results are recorded in confidential report N° 90248-581521.

9 Compliance with the Essential Health and Safety Requirements has been assured by compliance with :
- EN 61241-0 (2006)
- EN 61241-1 (2004)

10 If the sign X is placed after the certificate number, it indicates that the equipment or protective system is subject to special conditions for safe use specified in the schedule to this certificate.

11 This EC type examination certificate relates only to the design and construction of this specified equipment or protective system in accordance with annex III to the directive 94/9/EC. Further requirements of the directive apply to the manufacturing process and supply of this equipment or protective system. These are not covered by this certificate.

12 The marking of the equipment or protective system shall include informations as detailed at 15.
Fontenay-aux-Roses, le 16 mars 2009

Mfrc GILLAUX
responsable de certification ATEX
ATEX certification manager

Seul le texte en français peut engager la responsabilité du LCIE. Ce document ne peut être reproduit que dans son intégralité, sans aucune modification.
The LCIE's liability applies only on the French text. This document may only be reproduced in its entirety, without any change.

Page 1 of 3
LCIE n°0081
www.lcie.com
Tél: +33 (0)1 47 39 10 00
Fax: +33 (0)1 47 39 10 01
E-mail: info@lcie.com

M000731

ABB

EC Declaration of Conformity

The Manufacturer: **ABB Oy Motors**
P.O. Box 633
Strombergin puistotie 5A
FIN - 65101 Vaasa, Finland

hereby declares that

the products: **3-phase induction motors, series M2GP, M3JP, M3JC, M3KP, M3VC, M3GP, M3HP and M3LP, as listed on page 2 in this document, fulfil provisions of the relevant Council Directives:**

Directive 94/9/EC (ATEX of 23rd March 1994)

by applying the following harmonized standards:
EN 60079-0 (2006), EN 60079-1 (2007), EN 60079-7 (2007), EN 60079-15 (2005), EN 61241-0 (2006), EN 61241-1 (2004).

ABB Oy Motors declare on it's sole responsibility,
- that the state of the art of these standards do not modify the result of the assessment carried out by LCIE which issued the EC type examination certificates according to former editions of the standard series.
- that listed motors conform to the requirements of annex II of the directive 94/9/EC clause 1.2.7 by applying the standards serie EN 60034.

Directive 2005/32/EC (EuP of 6th July 2005)

by fulfilling the requirements of the standard EN 60034-30 (March 2009) in respect of the efficiency class.

Note: When installing motors for converter supply applications additional requirements must be respected regarding the motor as well as the installation, as described in the appropriate detailed addendum.

Signed by: *[Signature]*
Title: **Jouni Ikaheimo
Product Development Manager**

Date: **April 29th, 2010** **3GZF500930-988**

ABB Oy

Motors: P.O. Box 633, FI-65101 Vaasa, FINLAND
Visiting Address: Strombergin Puistotie 5 A, FINLAND
Telephone: +358 10 22 11
Telefax: +358 10 22 47372
Internet: www.abb.fi
e-mail: first.name.last.name@fi.abb.com
Business Identity Code: 0763403-0
Domicile: Helsinki

M000725-1

2(2)

2010-04-29

ABB

Certificates: 3-phase induction motors, series M2GP, M3JP, M3KP, M3HP, M3LP

Group & category, Temperature class, protection	Motor type, IEC frame size	Certification number	Year of CE-marking
Flameproof II 2 G Ex d IIB / I C T1-T6 II 2 G Ex d I B / IIC T1-T6 In addition: II 2 D Ex ID A21 / IP 65 or II 3 D Ex ID A22 / IP 55, IP65 (3D not for M3JP/KP160-180 Gen.H)	M3JPM3KP 80	LCIE 04 ATEX 6150	2004
	M3JPM3KP 90	LCIE 04 ATEX 6151	2004
	M3JPM3KP 100-112	LCIE 04 ATEX 6152	2004
	M3JPM3KP 132	LCIE 04 ATEX 6061	2004
	M3JPM3KP 160	LCIE 00 ATEX 6023	2000
	M3JPM3KP 180	LCIE 00 ATEX 6028	2000
	M3JPM3KP 180 Gen.H	LCIE 09 ATEX 3004X	2009
	M3JPM3KP 180 Gen.H	LCIE 09 ATEX 3005X	2009
	M3JPM3KP 200	LCIE 00 ATEX 6027	2000
	M3JPM3KP 225	LCIE 00 ATEX 6029	2000
	M3JPM3KP 250	LCIE 00 ATEX 6030	2000
	M3JPM3KP 280	LCIE 01 ATEX 6078	2001
M3JPM3KP 315	LCIE 01 ATEX 6079	2001	
M3JPM3KP 355	LCIE 03 ATEX 6080	2003	
M3JPM3KP 400	LCIE 04 ATEX 6087	2004	
Increased safety II 2 G Ex e II T2-T3 In addition for M3HP160 - 400: II 2 D Ex ID A21	M3HP 80-90	LCIE 09 ATEX 6047	2006
	M3HP 100-112	LCIE 06 ATEX 6048	2006
	M3HP 132	LCIE 06 ATEX 6049	2006
	M3HP 160	LCIE 01 ATEX 6015	2001
	M3HP 180	LCIE 01 ATEX 6021	2001
	M3HP 160 Gen.H	LCIE 09 ATEX 3022	2009
	M3HP 180 Gen.H	LCIE 09 ATEX 3023	2009
	M3HP 200	LCIE 01 ATEX 6022	2001
	M3HP 225	LCIE 01 ATEX 6023	2001
	M3HP 250	LCIE 01 ATEX 6024	2001
	M3HP 280	LCIE 02 ATEX 6071	2002
	M3HP 315	LCIE 02 ATEX 6072	2002
M3HP 355	LCIE 03 ATEX 6022	2003	
M3HP 400	LCIE 04 ATEX 6013	2004	
Non-sparking II 3 C Ex nA II T2-T3	M2GP 71-250	LCIE 05 ATEX 6160	2005
	M2GP 80 - 400	LCIE 05 ATEX 6089	2005
	M3GP 160 - 180 Gen.H	LCIE 09 ATEX 1010 *	2009
M3GPM3LP 450	LCIE 06 ATEX 6088	2006	
Dust ignition II 2 D Ex ID A21 IP 65	M3GP 160 - 180 Gen.H	LCIE 09 ATEX 3016	2009
	M3GP 160 - 180 Gen.H	LCIE 09 ATEX 1010 *	2009
Dust ignition II 3 D Ex ID A22	M3GPM3LP 450	LCIE 06 ATEX 6088	2006
	M2GP 71-250	LCIE 05 ATEX 6160	2005
Dust ignition II 2 D Ex ID A21 IP 65 or II 3 D Ex ID A22 IP 55, IP65	M3GP 80 - 400	LCIE 06 ATEX 6089	2006

1) Notified Body (ExNB): LCIE (0081); Av. Du Général Leclerc; 33, 92268 Fontenay-aux-Roses, France
2) *) Voluntary Type Examination Certificate for equipment category 3

3GZF500930-988

M000725-2

Non-sparking motors with cast iron frame in brief, basic design

Motor size		80	90	100	112	132	160	180	
Stator	Material	Cast iron, at least EN-GJL-200							
	Paint colour shade	Blue, Munsell 8B 4.5/3.25 / NCS 4822 B05G							
	Corrosion class	C3 medium according to ISO/EN 12944-5							
Bearing end shields	Material	Cast iron, at least EN-GJL-200							
	Paint color shade	Blue, Munsell 8B 4.5/3.25 / NCS 4822 B05G							
	Corrosion class	C3 medium according to ISO/EN 12944-5							
Bearings	D-end	2-pole	6205-2Z/C3	6205-2Z/C3	6206-2Z/C3	6206-2Z/C3	6208-2Z/C3	6309-2Z/C3	6310-2Z/C3
		4-8 -pole							
	N-end	2-pole	6204-2Z/C3	6205-2Z/C3	6206-2Z/C3	6206-2Z/C3	6208-2Z/C3	6309-2Z/C3	6309-2Z/C3
		4-8 -pole							
Axially-locked bearings	Inner bearing cover	As standard, locked at D-end							
Bearing seal		Gamma ring							
Lubrication		Permanent grease lubrication.					Regreasable bearings		
SPM-nipples		-					As standard		
Rating plate	Material	Stainless steel							
Terminal box	Frame material	Cast iron, at least EN-GJL-200							
	Cover material	Cast iron, at least EN-GJL-200							
	Screws	Steel 8.8, zinc electroplated and chromated							
Connections	Cable entries	2xM25x1.5		2xM32x1.5			2xM40x1.5		
	Terminals	6 terminals for connection with cable lugs (not included)							
Fan	Material	Polyamide. Reinforced with glass fibre.					Polypropylene. Reinforced with glass fibre.		
Fan cover	Material	Steel					Hot dip galvanized steel		
	Paint colour shade	Blue, Munsell 8B 4.5/3.25 / NCS 4822 B05G							
	Corrosion class	C3 medium according to ISO/EN 12944-5							
Stator winding	Material	Copper							
	Insulation	Insulation class F							
	Winding protection	3 pcs thermistors							
Rotor winding	Material	Pressure die-cast aluminum							
Balancing method		Half key balancing							
Key ways		Open key-way							
Heating elements	On request	25 W							
Drain holes		Optional					As standard, open on delivery		
External earthing bolt		As standard							
Enclosure		IP 55							
Cooling method		IC 411							

Non-sparking motors with cast iron frame in brief, basic design

Motor size		200	225	250	280	315	355	400	450	
Stator	Material	Cast iron, at least EN-GJL-200								
	Paint colour shade	Blue, Munsell 8B 4.5/3.25 / NCS 4822 B05G								
	Corrosion class	C3 medium according to ISO/EN 12944-5								
Bearing end shields	Material	Cast iron, at least EN-GJL-200								
	Paint color shade	Blue, Munsell 8B 4.5/3.25 / NCS 4822 B05G								
	Corrosion class	C3 medium according to ISO/EN 12944-5								
Bearings	D-end	2-pole	6312/C3	6313/C3	6315/C3	6316/C3	6316/C3	6316M/C3	6317/C3	6317/C3
		4-8 -pole	6312/C3	6313/C3	6315/C3	6316/C3	6319/C3	6322/C3	6324/C3	6324/C3
	N-end	2-pole	6310/C3	6312/C3	6313/C3	6316/C3	6319/C3	6316M/C3	6317/C3	6317/C3
		4-8 -pole	6310/C3	6312/C3	6313/C3	6316/C3	6316/C3	6316/C3	6319/C3	6319/C3
Axially-locked bearings	Inner bearing cover	As standard, locked at D-end								
Bearing seal	M3GP	Gamma ring				V-ring				
	M4GP	Gamma ring				Labyrinth seal			NA	
Lubrication		Regreasable bearings				Regreasable bearings				
SPM-nipples		As standard				Optional		As standard		
Rating plate	Material	Stainless steel								
Terminal box	Frame material	Cast iron, at least EN-GJL-200								
	Cover material	Cast iron, at least EN-GJL-200								
	Cover screws material	Steel 8.8, zinc electroplated and chromated								
Connections	Cable entries	2xM50x1.5				2xM63x1.5		2xØ60/80	2xØ80	2xØ80
							2xØ60	2xØ60/80	2xØ60/80	
	Terminals	6 terminals for connection with cable lugs (not included)								
Fan	Material	Polypropylene. Reinforced with glass fibre.						Polypropylene. Reinforced with glass fibre or aluminum.		
Fan cover	Material	Hot dip galvanized steel								
	Paint color shade	Blue, Munsell 8B 4.5/3.25 / NCS 4822 B05G								
	Corrosion class	C3 medium according to ISO/EN 12944-5								
Stator winding	Material	Copper								
	Insulation	Insulation class F								
	Winding protection	3 pcs thermistors								
Rotor winding	Material	Pressure die-cast aluminum								
Balancing method		Half key balancing								
Key ways		Closed key way				Open key way				
Heating elements	Optional	25 W	60 W			120 W				
Drain holes		As standard, open on delivery								
External earthing bolt		As standard								
Enclosure		IP 55								
Cooling method		IC 411								

Non-sparking motors with aluminum frame in brief, basic design

Motor size		63	71	80	90	100	112	132	
Stator	Material	Die-cast aluminum alloy							
	Surface treatment	Munsell blue 8B 4.5/3.25 / NCS 4822-B05G						Polyester powder paint $\geq 50 \mu\text{m}$	
		Powder coating based on polyester resin, $\geq 30 \mu\text{m}$							
Feet	Material	Aluminum alloy					Aluminum alloy		
		Loose feet, bolted to the stator					Integrated with the stator		
Bearing end shields	Material	Diecast aluminum alloy							
	Surface treatment	Munsell blue 8B 4.5/3.25 / NCS 4822-B05G						Polyester powder paint $\geq 50 \mu\text{m}$	
		One-component polyester resin powder, $\geq 30 \mu\text{m}$							
Bearings	D-end	2-pole	6202-2Z/C3	6203-2Z/C3	6204-2Z/C3	6205-2Z/C3	6306-2Z/C3	6206-2Z/C3	6208-2Z/C3
		4-8 pole							
	N-end	2-pole	6201-2Z/C3	6202-2Z/C3	6203-2Z/C3	6204-2Z/C3	6205-2Z/C3	6205-2Z/C3	6206-2Z/C3
		4-8 pole							
Axially-locked bearings	Inner bearing cover	D-end						D-end ¹⁾	
		¹⁾ Foot motor - a spring washer at N-end presses the rotor against D-end							
		Flange motor - inner bearing cover and spring washer at N-end							
Bearing seal	D-end	V-ring							
	N-end	Labyrinth seal							
Lubrication		Permanently lubricated bearings. Grease for bearing temperatures -40 to +160°C.							
Terminal box	Material	Die-cast aluminum alloy					Die-cast aluminum alloy, base integrated with stator.		
	Surface treatment	Similar to stator					Phosphated, polyester paint.		
	Screws	Steel 5G. Galvanised and yellow chromated.							
Connections	Knock-out openings	1 x (M16 x Pg11)	2 x (M20 + M20)		2 x (M25 + M20)				
	Terminal box	Cable lugs. 6 terminals.				Screw terminal. 6 terminals.		Cable lugs. 6 terminals.	
	Screws	M4						M5	
	Max Cu-area, mm ²	2.5	4	6			10		
Fan	Material	Polypropylene. Reinforced with 20% glass fibre.							
Fan cover	Material	Steel sheet					Polypropylene		
Stator winding	Material	Copper							
	Impregnation	Polyester varnish. Tropicalised.							
	Insulation class	Insulation class F. Temperature rise class B, unless otherwise stated.							
	Winding protection	Optional							
Rotor winding	Material	Die-cast aluminum							
Balancing		Half key balancing							
Key ways		Closed key way							
Heating elements		8 W			25 W				
Drain holes		Drain holes with closable plastic plugs. Closed on delivery.							
External earthing bolt		As standard							
Enclosure		IP 55							
Cooling method		IC 411							

Non-sparking motors with aluminum frame in brief, basic design

Motor size		160	180	200	225	250	280	
Stator	Material	Diecast aluminum alloy		Extruded aluminum alloy				
	Paint colour shade	Munsell blue 8B 4.5/3.25 / NCS 4822 B05G						
	Surface treatment	Polyester powder paint $\geq 50 \mu\text{m}$						
Feet	Material	Aluminum alloy, integrated with stator.		Aluminum alloy, bolted to the stator. Frame size 250, 2-pole, cast iron.		Cast iron		
Bearing end shields	Material	Cast iron						
	Paint colour shade	Munsell blue 8B 4.5/3.25 / NCS 4822 B05G						
	Surface treatment	Polyester powder paint $\geq 50 \mu\text{m}$						
Bearings	D-end	2-pole	6309-2Z/C3	6310-2Z/C3	6312-2Z/C3	6313-2Z/C3	6315-2Z/C3	6315/C3
		4-8 -pole						
	N-end	2-pole	6209-2Z/C3	6209-2Z/C3	6210-2Z/C3	6212-2Z/C3	6213-2Z/C3	6213/C3
		4-8 -pole						
Axially-locked bearings	Inner bearing cover	D-end						
Bearing seal	D-end	V-ring		Outer and inner V-rings				
	N-end	Labyrinth seal		Outer and inner V-rings				
Lubrication		Permanently lubricated shielded bearings						Valve lubrication
Terminal box	Material	Die-cast aluminum alloy. Base integrated with stator.		Deep-drawn steel sheet, bolted to stator.				
	Surface treatment	Similar to stator		Phosphated. Polyester paint.				
	Screws	Steel 5G. Galvanised.						
Connections	Knock-out openings	2 x (2 x M40) + M16						2 x FL21
	Flange-openings				2 x FL 13.2 x M40		2 x M63	
	Flange-openings				2 x FL 21.2 x M63 (voltage code S)		1 X M16	
	Terminal box	Cable lugs. 6 terminals.						
	Screws	M6			M10			
	Max Cu-area, mm ²	35			70			
Fan	Material	Polypropylene. Reinforced with 20% glass fibre.						
Fan cover	Material	Steel sheet. Galvanized.						
Stator winding	Material	Copper						
	Impregnation	Polyester varnish						
	Insulation class	Insulation class F. Temperature rise class B, unless otherwise stated.						
Stator winding temperature sensors		Optional. PTC-thermistors, 150°C						
Rotor winding		Die-cast aluminum						
Balancing method		Half key balancing						
Key ways		Closed keyway						
Heating elements		25 W	50 W					
Drain holes		Drain holes with closable plastic plugs. Closed on delivery.						
Enclosure		IP 55						
Cooling method		IC 411						

www.jamcosanat.com

Dust ignition proof motors /
Protection by enclosure
Totally enclosed squirrel cage three
phase low voltage motors,
Sizes 63 - 400, 0.12 to 710 kW



www.abb.com/motors&generators

- > Motors for explosive atmospheres
- >> Dust ignition proof motors

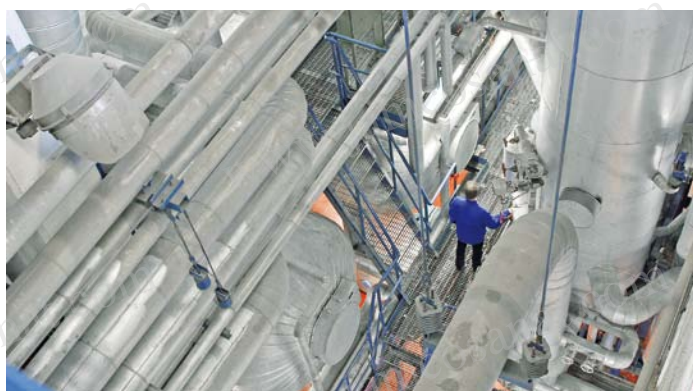

Mechanical design

Drain holes

Dust ignition proof motors in IP65 construction are delivered without drain holes.

Motors in IP55 construction are delivered with drain holes and plugs in closed position.

Type of protection	Frame material	Frame size	Drain holes
Dust ignition proof, category 2D, IP 65	Cast iron	80-400	not included
Dust ignition proof, category 3D, IP 55	Cast iron	80-132	optional
		160-400	closed
Dust ignition proof, category 2D, IP 65	Aluminum	90-280	not included
Dust ignition proof, 3D, IP 55	Aluminum	63-280	closed

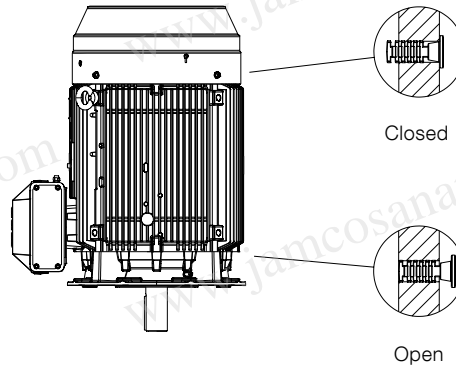
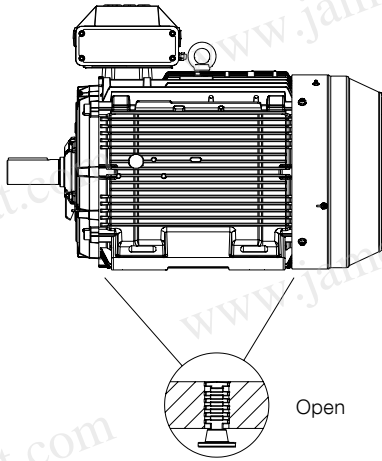

M000178

Terminal box standard delivery, cast iron frames

Terminal boxes are mounted on top of the motor at D-end as standard. The terminal boxes of motor sizes 80-355 can be turned 4x90° and in motor sizes 400 2x180° after delivery. When ordering DIP motors in sizes 280-400 with 4x90°, the position of the terminal box has to be defined in the order.

The degree of protection of the standard terminal box is IP55 or IP65 according to the category and it complies with the requirements of this enclosure type and effectively prevents all ignition sources such as sparks, excessive overheating etc. The features of the terminal box are : no selfloosening terminals, compliance with creepage distances and clearances specified in standards.

If no ordering information on the cable is given, it is assumed to be p.v.c. -insulated non-armoured and termination parts are supplied according to the table on the following pages. To enable the supply of suitable terminations for the motor, please state cable type, quantity, size and outer diameter when ordering.

All DIP/ExtD motors are delivered as standard with cable glands or cable sealing end units according to the below table. Different glands can be provided separately as an option. Please see Alternatives section for details.

Note: For 500 V motor information please contact ABB!

Standard delivery 400/690 V (if nothing else informed)

Motor size	Pole number	Terminal box type	Terminal box opening	45° adapter (variant code)	Threaded holes	Cable gland	Cable sealing end unit (variant code)	Cable outer diameter mm	Single core cross-section mm ² for rated power	Terminal bolt size 6 x
80-90	2-8	25	B	-	1xM25	1xM25	-	Ø10-16	10	M5
100-132	2-8	25	B	-	2xM32	2xM32	-	Ø16-21	10	M5
160-180	2-8	63	B	-	2xM40	2xM40	-	2xØ18-27	35	M6
200-250	2-8	160	B	-	2xM50	2xM50	-	2xØ26-35	70	M10
280	2-8	210	C	-	2xM63	2xM63	-	2xØ32-49	2x150	M12
315SM, ML	2-8	370	D	-	2xM63	2xM63	-	2xØ32-49	2x240	M12
315LKA, LKB	2-4	370	D	-	2xM63	2xM63	-	2xØ32-49	2x240	M12
315LKC	2-4	750	E	E-D (294)	-	-	medium (278)	2xØ48-60	4x240	M12
315 LKA, LKB, LKC	6-8	370	D	-	2xM63	2xM63	-	2xØ32-49	2x240	M12
355 SMA, SMB, SMC	2-4	750	E	E-D (294)	2xM63	2xM63	medium (278)	2xØ48-60	4x240	M12
355 SMC	6	750	E	E-D (294)	2xM63	2xM63	medium (278)	2xØ48-60	4x240	M12
355 SMC	8	370	D	-	2xM63	2xM63	-	2xØ32-49	2x240	M12
355 SMA, SMB	6-8	370	D	-	2xM63	2xM63	-	2xØ32-49	2x240	M12
355 ML, LK	2-4	750	E	E-D (294)	-	-	large (279)	2xØ60-80	4x240	M12
355 ML, LK	6-8	750	E	E-D (294)	-	-	medium (278)	2xØ48-60	4x240	M12
400 L, LK	2-6	750	E	E-D (294)	-	-	large (279)	2xØ60-80	4x240	M12
400 L, LK	8	750	E	E-D (294)	-	-	medium (278)	2xØ48-60	4x240	M12

Auxiliary cable entries

80-132	2-8	1xM20	1xM20	1xØ8-14
160-400	2-8	2xM20	2xM20	1xØ8-14

Earthings on motor

	Frame	Terminal box
80-132	M6	M6
160-180	M6	M6
200-250	M8	M8
280-315	M10	2xM10
355-400	M10	2xM10

Terminal box alternatives, cast iron frame

Optional adapters

There is a broad selection of cable termination accessories available to allow termination of one or several cables. The most common ones are explained below, for other options please contact ABB.

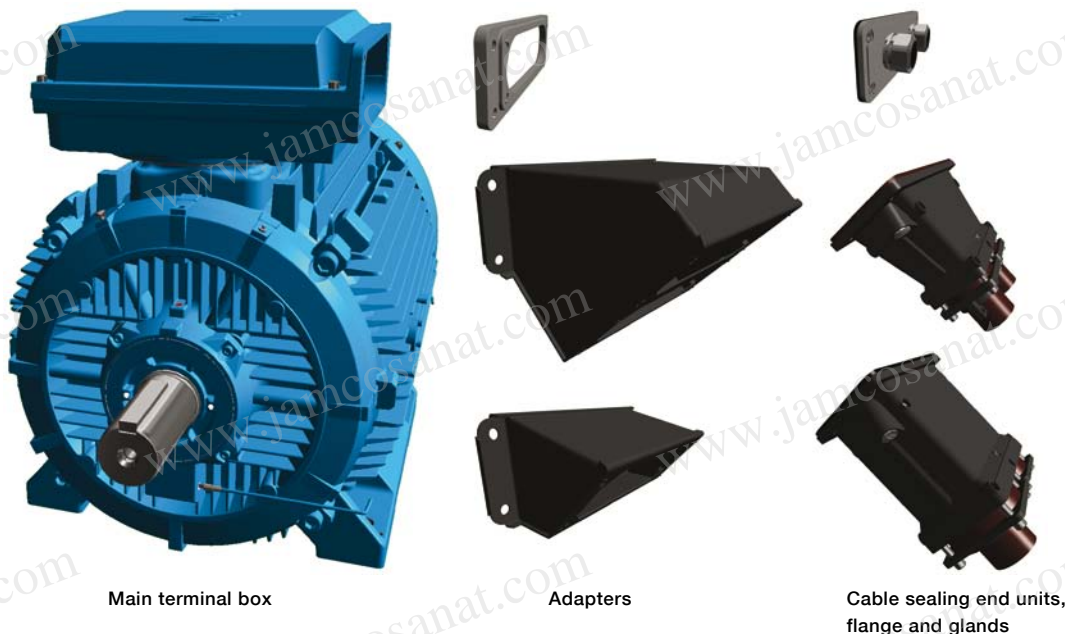

Main terminal box

Adapters

Cable sealing end units, flange and glands

M000443

How to order?

- Check first that the terminal box can allow mounting of the cable and cores (refer to motor type and terminal box type cross reference page 173).
- If very large cables are used might it be necessary to use a larger terminal box than standard. Select the right cable gland(s) or cable sealing end unit(s) depending on outer diameter of the cable(s).
- Select a appropriate adapter and gland(s) and gland plate or cable sealing end unit.
- Note that turning the terminal box to a non standard position might limit the use of some adapters.

Ordering example

Motor	200 kW, 4 pole, 400 V 50 Hz,
Cables	cables needed: 2 pieces, outer diameter 58 mm, single cross section 185mm, cables coming from below
Needed one terminal box for anticondensation heaters (220V) and another for temperature detectors, terminal box material cast iron.	
Motor	M3GP 315 MLA 4, B3
Adapter	D-D (variant code 293)
Cable sealing end unit	Variant code 278
Auxiliaries	Variant codes 451, 380, 567, 568

1. Main terminal box and maximum single core cross section

Larger than standard single core cross section is available as option according to the table below. Also one size larger terminal box can be selected. Please check also the capacity of the cable entry to make sure the cables fit.



Standard terminal box	Size of opening	Max single cross section per phase mm ²	Variant code 019 larger terminal box than standard	Size of opening with larger terminal box than standard Variant code 019	Max single cross section per phase mm ²
25	B	35	-	-	-
63	B	95	-	-	-
160	C	120	-	-	-
210	C	2 x 240	370	D	2 x 300
370	D	2 x 300	750	E	4 x 500
750	E	4 x 500	1200	E	4 x 500

The accessories for using the maximum single core cross sections are not included as standard. For this option please use variant code 300 (Increased single core cross section). Each terminal has got limited maximum cable entry size, please request if necessary.

2. Optional adapters

To allow easy termination of cables entering the terminal box from above or below it is recommended to use an angle adapter.

These can also be used to allow mounting of several cable sealing end units or gland plates on the terminal box for termination of more cables than one cable sealing end unit or gland plate can allow.

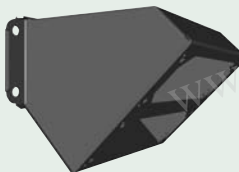
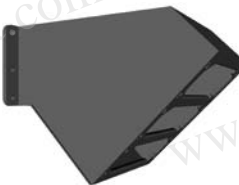
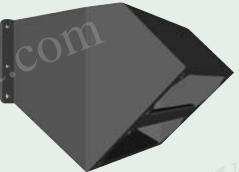
Adapter	Variant code	Opening towards terminal box	Glandplate or opening for cable sealing end unit	Material	Notes
	292 M000430	C	C	Steel	
	293 M000431	D	D	Steel	
	294 M000432	E	D	Steel	Included in std delivery with 750 type terminal box
	295 M000433	E	2 pcs E	Steel	Only possible on terminal box 1200
	296 M000434	E	3 pcs D	Steel	Only possible on terminal box 1200
	444 M000435	E	2 pcs D	Steel	Included in std delivery with 1200 type terminal box

Note: Black painted steel

3. Glandplate, maximum size of glands and material

Glandplates delivered blind or be drilled and tapped to accommodate glands to suit the cable diameter and amount of glands needed.

Standard gland plate material is siluminium, painted steel or stainless steel are available as options.

Size	Maximum size and number of glands, metric		
C	2xM90	3xM50	7xM32
D	4xM90	4xM63	7xM50
E	6xM90	7xM63	9xM50

Related variant codes:

- 729 Cable flanges without holes / Blank gland plates.
- 730 Prepared for NPT glands
- 732 Standard cable gland, Ex d IIB, armoured cable.
- 733 Standard cable gland, Ex d IIB, non-armoured cable.
- 743 Painted steel, blind
- 744 Stainless steel, blind
- 745 Painted steel with brass glands
- 746 Stainless steel with brass glands

4. Cable glands and cable sealing end units

Cable glands

Table below shows the selection of cable gland types and possible cable outer diameter of each size.

Outer diameter, mm			
	Variant code 745	Variant code 737	Variant code 704
	Painted steel flange equipped with brass cable glands	Standard cable gland Ex e with clamping device acc. to EN-Standards	EMC cable gland
Motor sizes 80-450:			
M20	8-14	8-14	8-14
M25	10-16	10-16	10-16
M32	14-21	14-21	14-21
M40	18-27	18-27	18-27
M50	26-35	26-35	26-35
M63	32-49	32-49	32-49
M75	46-60	NA	NA
M90	55-70	NA	NA



For armoured and NPT cable glands please contact ABB.

Cable sealing end unit

As an alternative to flanges and cable glands, cable sealing units can be used. These allow more space for spreading the cores for easy terminating on the terminals.

Cable sealing end units have rubber sealed entries for one or two main cables. In addition are there two M20 plugged holes for auxiliary cables.



					Accessories	
Variant code	Opening towards terminal box	Cable outer diameter mm	Cable entry auxiliary cable	Variant code 704; EMC cable gland	Variant code 231; Standard cable gland with clamping device	
 M000436 277	C	1 or 2 pcs (48-60 mm *)	2 pcs M20 plugged holes	Optional	Optional	
 M000437 278	D	1 or 2 pcs (48-60 mm *)	2 pcs M20 plugged holes	Optional	Optional	
 M000438 279	D	1 or 2 pcs (60-80 mm *)	2 pcs M20 plugged holes	Optional	Optional	

*) Depending on how the cable seal inside the cable sealing end unit is used also 40-52mm is available.

5. Auxillary terminal box

It's possible to equip the motors from frame size 160 upwards with one or several auxillary terminal boxes for connection of auxiliaries like heaters or temperature detectors.

The standard auxillary terminal box is made of aluminium and equipped with M20 glands for entry of the connection cables. As an option cast iron terminal box is available.

Connection terminals are spring loaded type for quick and easy connection. These are suitable for up to 2,5mm² wires. Auxillary terminal boxes are equipped with an earthing terminal.

As standard the first auxillary terminal box is located on RHS seen from D-end.

Small, aluminum auxiliary terminal box
(80 x 125 mm, for max. 12 wires)
Earthing size M4



M000439

Large, aluminum auxiliary terminal box
(80 x 250 mm, for max. 30 wires)
Earthing size M4



M000440

Cast iron auxiliary terminal box
(211 x 188 mm, for max. 30 wires)
Earthing size M6



M000441

Standard cable entry size M20. Number of entries depends on the terminal box type and number of selected auxiliaries.

Related variant codes:

- 418 Separate terminal box for auxiliaries, standard material (all connections of temperature detectors and heaters will be put in same box)
- 380 Separate terminal box for temperature detectors, standard material
- 568 Separate terminal box for heating elements, standard material
- 569 Separater terminal box for brakes, standard material
- 567 Separate terminal box material: Cast iron

Dimension drawings

Dust ignition proof, cast iron frame

Terminal boxes, standard design with 6 terminals

Motor sizes 80 - 132

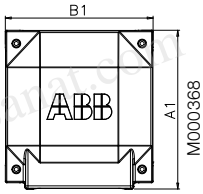

M000368

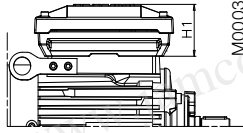

M000368

Motor sizes 160 - 180

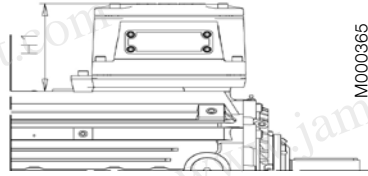

M000365

Motor sizes 200 - 250

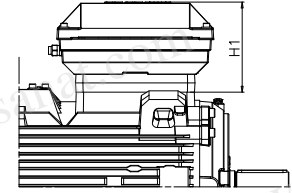

M000369

Motor sizes 280 - 315

Top- and side-mounted
Terminal boxes 210, 370

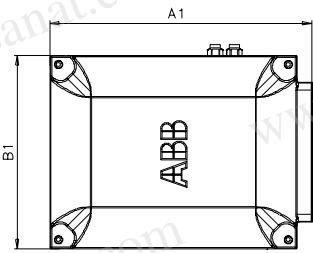
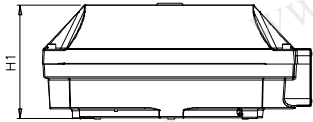

M000205

Motor sizes 355 - 400

Top-mounted
Terminal box 750 + adapter

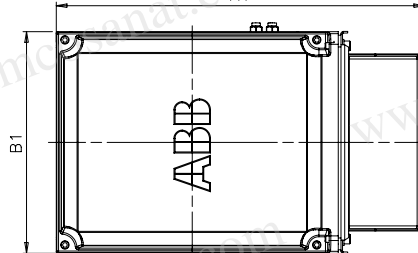

M000206

Side-mounted
Terminal box 750

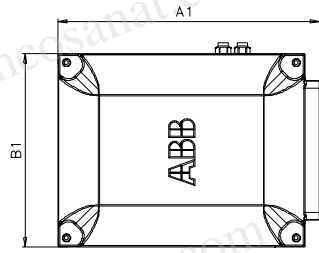
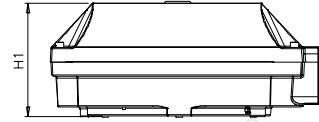

M000205

Motor size	Terminal box	A1	B1	H1
80-132	25	202	188	66
160-180	63	234	234	68
200-250	160	352	319	147
280-400	210	416	306	177
315-370	370	451	347	200
355-400	750 top-mounted	686	413	219
355-400	750 side-mounted	525	413	219

Terminal box alternatives, aluminum frame

Sizes 63 to 180

The terminal box is made of aluminum alloy and is located on top of the stator. The lower part of the box is integrated with the stator. It is provided with two knockout openings on each side. Sizes 132 SM_ and 160-180 also have a third smaller opening. Cable glands are not included.

Sizes 200 to 280

The terminal box and cover are made of deep drawn steel and mounted on top of the stator. The box is bolted to the stator and is not rotatable. The size of the box is the same for all motors.

In the basic design the terminal box is provided with two

FL 13 flange openings, one on each side. The opening on the right side, seen from the D-end, is supplied with a flange with two holes for M40 cable glands. On delivery the holes are sealed by means of plastic plugs. Cable glands are not supplied. The opening on the other side is provided with a cover flange.

The motors can also be provided with an extra large terminal box, standard for voltage code S and frame size 280. See variant code 019 under the heading "Terminal box". This will increase the dimension HD by 32 mm. The box is supplied with two FL 21 openings. The right opening is provided with a flange with two holes for M63 cable glands. The holes are sealed by means of plastic plugs. Cable glands are not supplied. The opening on the other side is provided with a cover flange. The box can also be provided with an FL 13 opening towards the N-end.

When new motors are manufactured the terminal box can be mounted on the left or the right side. See variant codes 021 and 180 under the heading "Terminal box".

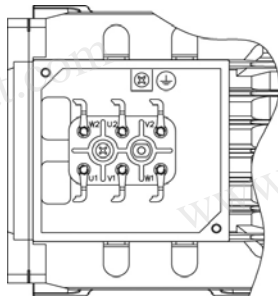

Terminal board for motor size 63

M000016

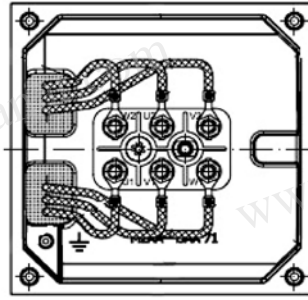

Terminal board for motor sizes 71 to 80

M000521

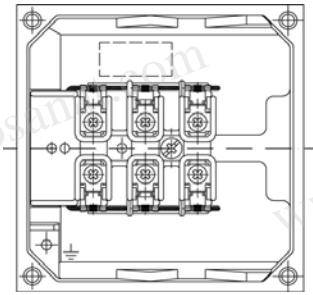

Terminal board for motor sizes 90 to 112

M000017

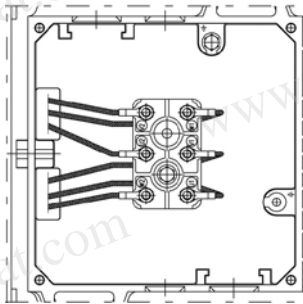

Terminal board for motor size 132

M000018

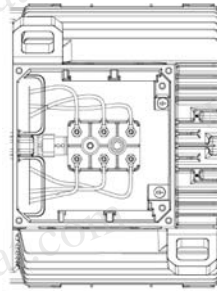

Terminal board for motor sizes 160 to 180

M000501

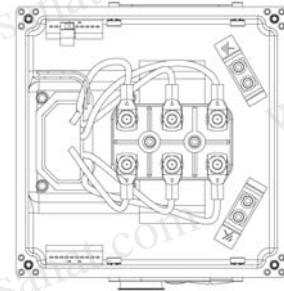

Terminal board for motor sizes 200 to 280

M000500

Connections

The terminal block is provided with six terminals for connecting Cu-cable. The terminals are marked in accordance with IEC 60034-8.

Connection openings

Motor size	Opening	Metric cable entry	Method of connection	Terminal bolt size	Maximum connectable Cu-cable area, mm ²
63	Knock-out opening	1 x M16 x 1.5 1 x Pg 11	Cable lug	M4	2.5
71-80	Knock-out opening	2 x (2 x M20)	Cable lug	M4	4
90-112	Knock-out opening	2 x (M25 + M20)	Screw terminal	M4	6
132 ¹⁾	Knock-out opening	2 x (M25 + M20)	Cable lug	M5	10
132 ²⁾	Knock-out opening	2 x (M40 x M32 + M12)	Cable lug	M6	35
160-180	Knock-out opening	2 x (2 x M40 + M16)	Cable lug	M6	35
200-250	2 x FL 13	1 x (2 x M40 + M16)	Cable lug	M10	70
280	2 x FL 21	1 x (2 x M63 + M16)	Cable lug	M10	70

¹⁾ all types except ²⁾

²⁾ SM_

Dimensions for terminal box

Code 019 Larger than standard terminal box

Motor size	Dimensions	Dimensions			
		AD	HB	HD	HE
M3AA 200 ML.		332.5	332.5	603	240
M3AA 225 SM.		353	353	578	260.5
M3AA 250 SM.		376	376	626	283.5

Code 021 Terminal box on left-hand side seen from D end

Code 180 Terminal box on right-hand side seen from D end

Motor size	Dimensions	Dimensions			
		AD	HB	HD	HE
M3AA 200 ML.		332	332	532	239
M3AA 225 SM.		354	354	579	260.5
M3AA 250 SM.		377	377	627	284

Code 467 Lower than standard terminal box without screw terminals and extended rubber connection cable 2 m.

Motor size	Dimensions		
	AD	HB	HD
160		211.5	371.5
180		226.5	406.5
200 ML.	248	248	448
225 SM.	269	269	494
250 SM.	292	292	542
280	292	292	572

Permissible loadings on the shaft end

The following tables give the permissible radial and axial forces in Newton, assuming only radial or axial force is applied. Permissible loads of simultaneous radial and axial forces will be supplied on request.

The bearing life, L_{10} , is calculated according to ISO 281:1990/ Amd 2:2000 standard theory, which also takes the purity of the grease into consideration. An adequate lubrication is a necessary prerequisite for the table below.

The values are based on normal conditions at 50 Hz. At 60 Hz the values must be reduced by 10 %. For two-speed motors, the values must be based on the higher speed.

Motors are foot-mounted IM B3 version with force directed sideways. In some cases the strength of the shaft affects the permissible forces.

If the bearing at the D-end is replaced with a roller bearing (NU- or NJ-), higher radial forces can be handled. Roller bearings are suitable for belt drive applications.

If the radial force is applied between points X_0 and X_{max} , the permissible force F_R can be calculated from the following formula:

$$F_R = F_{X_0} - \frac{X}{E} (F_{X_0} - F_{X_{max}})$$

E = length of shaft extension in basic version

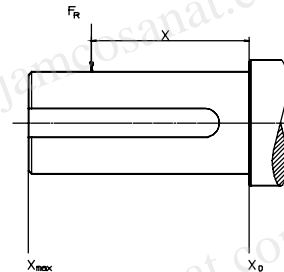

M000145

Cast iron motors, sizes 80 to 132

Permissible radial forces according to L_{10} principle

Dust ignition proof

Motor size	Poles	Length of shaft extension E (mm)	Ball bearings 40,000 hours	
			F_{X_0} (N)	$F_{X_{max}}$ (N)
80	2	40	619	524
	4	40	780	663
	6	40	893	759
	8	40	983	834
90	2	50	561	473
	4	50	803	677
	6	50	919	775
	8	50	1011	853
100	2	60	553	457
	4	60	1050	868
	6	60	1267	1047
	8	60	1395	1153
112	2	60	553	457
	4	60	1050	868
	6	60	1267	1047
	8	60	1394	1152
132	2	80	1354	1112
	4	80	1772	1454
	6	80	2028	1665
	8	80	2234	1833

Cast iron motors, sizes 160 to 400

Permissible radial forces according to L₁₀ principle

Dust ignition proof motors

Motor size	Poles	Length of shaft extension E (mm)	Ball bearings				Roller bearings			
			20,000 hours		40,000 hours		20,000 hours		40,000 hours	
			FX ₀ (N)	FX _{max} (N)	FX ₀ (N)	FX _{max} (N)	FX ₀ (N)	FX _{max} (N)	FX ₀ (N)	FX _{max} (N)
160	2	110	3180	2200	2500	2100	7850	2200	6400	2200
	4	110	4000	2200	3150	2200	8800	2200	7850	2200
	6	110	4600	2200	3650	2200	8800	2200	8800	2200
	8	110	4950	2100	3900	2100	8800	2100	8750	2100
180	2	110	3650	3050	2900	2400	8400	3500	6950	3500
	4	110	4600	3850	3650	3050	9700	3500	8500	3500
	6	110	5250	4400	4150	3500	9700	3500	9700	3500
	8	110	5650	3050	4500	3050	9900	3050	9900	3050
200 ML ₋	2	110	4800	3950	3800	3150	11700	4550	9500	4550
	4	110	6050	4550	4800	3950	14400	4550	11700	4550
	6	110	6950	4550	5500	4550	16250	4550	13200	4550
	8	110	7650	4550	6050	4550	17700	4550	14400	4550
225 SM ₋	2	110	5450	4500	4350	3550	14300	4550	11650	4550
	4	140	6900	4650	5450	4400	17650	4650	14300	4550
	6	140	7900	4650	6250	4650	19900	4650	16200	4650
	8	140	8700	4650	6900	4650	21700	4650	17650	4650
250 SM ₋	2	140	6750	4100	5350	4100	18950	4100	15400	4100
	4	140	8550	5800	6750	5450	23350	5800	18950	5800
	6	140	9800	5800	7750	5800	26400	5800	21400	5800
	8	140	10750	5800	8550	5800	28750	5800	23350	5800
280 SM ₋	2	140	7300	6000	5800	4900	20400	6000	16500	6000
	4	140	9200	7800	7300	6200	25100	9200	20300	9200
	6	140	10600	8900	8400	7000	28300	9200	23000	9200
	8	140	11700	9200	9200	7800	30900	9200	25100	9200
315 SM ₋	2	140	7300	6000	5800	4950	20300	6000	16500	6000
	4	170	11400	9400	9000	7450	32500	9600	26600	9600
	6	170	13000	9600	10300	8500	37000	9600	30000	9600
	8	170	14400	9600	11400	9400	40300	9600	32700	9600
315 ML ₋	2	140	7400	6400	5850	5050	20600	5850	16700	5850
	4	170	11500	9700	9100	7650	32700	13600	26500	13600
	6	170	13200	11100	10400	8800	36900	13600	29900	13600
	8	170	14500	12200	11500	9700	40200	13600	32600	13600
315 LK ₋	2	140	7400	6550	5800	5150	20800	5550	16800	5550
	4	170	11500	10000	9100	7850	33100	13350	26800	13350
	6	170	13200	11400	10450	9050	37300	13350	30300	13350
	8	170	14600	12600	11550	10000	40800	13350	33100	13350
355 SM ₋	2	140	7350	6450	5750	5050	20600	7200	16700	7200
	4	210	15200	12600	12000	9950	45500	14000	36900	14000
	6	210	17500	14000	13800	11400	51400	14000	41700	14000
	8	210	19300	14000	15250	12600	56000	14000	45500	14000
355 ML ₋	2	140	7350	6550	5750	5100	20800	6750	16800	6750
	4	210	15300	12900	12000	10100	45900	13600	37200	13600
	6	210	17600	13600	13900	11600	51500	13600	42100	13600
	8	210	19400	13600	15300	12900	56000	13600	45900	13600
355 LK ₋	2	140	7350	6650	5650	5150	21000	6750	17000	6750
	4	210	15200	13000	11850	10200	46000	13000	37300	13000
	6	210	17500	13000	13700	11900	52000	13000	42000	13000
	8	210	19400	13000	15200	13000	56500	13000	46000	13000
400 LK ₋	2	170	7650	6850	4400	3900	23900	9050	19350	9050
	4	210	15600	11500	12150	10550	52500	11500	43300	11500
	6	210	17800	11500	13850	11500	60000	11500	48800	11500
	8	210	19700	11500	15350	11500	65700	11500	53200	11500
400 L ₋	2	170	7650	6850	4400	3900	23900	9050	19350	9050
	4	210	15600	13550	12150	10550	52500	16000	43300	16000
	6	210	17800	15450	13850	12000	60000	16000	48800	16000
	8	210	19700	16000	15350	13350	65700	16000	53200	16000

Permissible axial forces according to L₁₀ principle

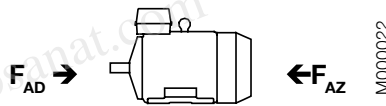

Cast iron motors, motor sizes 80 - 400

Mounting arrangement IM B3

Motor size	20,000 hours								40,000 hours							
	2-pole		4-pole		6-pole		8-pole		2-pole		4-pole		6-pole		8-pole	
	F _{AD} N	F _{AZ} N	F _{AD} N	F _{AZ} N	F _{AD} N	F _{AZ} N	F _{AD} N	F _{AZ} N	F _{AD} N	F _{AZ} N	F _{AD} N	F _{AZ} N	F _{AD} N	F _{AZ} N	F _{AD} N	F _{AZ} N
80	820	460	1010	650	1180	820))))))))))
90	900	380	1110	590	1260	740))))))))))
100	1330	440	1620	730	1820	940))))))))))
112	1330	440	1610	720	1820	930))))))))))
132 S ₋	1880	850	2330	1290	2650	1610))))))))))
160	2820	1910	3560	2650	4150	3240	4630	3720	2220	1310	2780	1870	3230	2320	3590	2680
180	3190	2280	4080	3170	4720	3810	5260	4350	2500	1590	3160	2250	3640	2740	4060	3150
200	4230	2960	5380	4120	6270	5000	6960	5700	3320	2060	4184	2920	4850	3590	5380	4120
225	4740	3270	6070	4600	7020	5550	7830	6360	3720	2250	4720	3250	5430	3970	6050	4590
250	6470	3370	8100	5000	9250	6150	10220	7130	5220	2130	6440	3340	7300	4210	8040	4950
280 SM ₋	4200	6250	6000	8000	5250	11250	8300	10300	2900	4900	4250	6250	5150	7150	5950	7950
315 SM ₋	4180	6200	7400	9400	8900	10900	10000	12000	2850	4850	5250	7250	6350	8350	7200	9000
315 ML ₋	4050	6050	7250	9250	8650	10650	9500	11900	2750	4750	5100	7100	6100	8100	6900	8800
315 LK ₋	4000	5950	7100	9150	8500	10500	9750	11750	2650	4650	5000	7000	5950	7950	6900	8900
355 SM ₋	3050	6850	8600	12400	10550	14350	12200	16000	1750	5550	5900	9700	7300	11100	8550	12350
355 ML ₋	2900	6700	8350	12150	10100	13900	12000	15800	1600	5400	5650	9450	6900	10700	7300	11000
355 LK ₋	2850	6650	8200	12000	9900	13700	11450	15250	1550	5350	5450	9250	6700	10500	7800	11600
400 LK ₋	2150	7150	7100	13100	8850	14850	10450	16450)	5800	4300	10300	5500	11500	6750	12750
400 L ₋	2150	7150	7100	13100	8850	14850	10450	16450)	5800	4300	10300	5500	11500	6750	12750

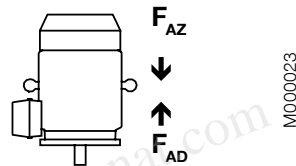

Mounting arrangement IM V1

Motor size	20,000 hours								40,000 hours							
	2-pole		4-pole		6-pole		8-pole		2-pole		4-pole		6-pole		8-pole	
	F _{AD} N	F _{AZ} N	F _{AD} N	F _{AZ} N	F _{AD} N	F _{AZ} N	F _{AD} N	F _{AZ} N	F _{AD} N	F _{AZ} N	F _{AD} N	F _{AZ} N	F _{AD} N	F _{AZ} N	F _{AD} N	F _{AZ} N
80	850	440	1060	650	1220	800))))))))))
90	940	350	1150	550	1320	690))))))))))
100	1400	390	1710	650	1940	860))))))))))
112	1410	380	1730	640	1950	850))))))))))
132 S ₋	2010	730	2520	1150	2890	1440))))))))))
160	3070	1660	4060	2320	4530	2890	4950	3350	2470	1060	3280	1530	3600	1970	3910	2310
180	3580	1980	4650	2680	5430	3340	5970	3890	2880	1280	3730	1760	4360	2260	4760	2680
200	4790	2480	6240	3550	7070	4300	7850	5020	3870	1560	5030	2340	5650	2890	6260	3430
225	5540	2670	7000	3860	8130	4700	8860	5480	4510	1650	5640	2500	6540	3100	7080	3700
250	7390	2640	9200	4080	10670	5000	11660	5970	6135	1380	7530	2410	8710	3040	9470	3780
280 SM ₋	5550	5150	7600	6550	9150	7500	10200	9000	4200	3800	5800	4750	7000	5350	7850	6700
315 SM ₋	5950	4600	9750	7500	11600	8300	13350	9900	4600	3300	7550	5300	9050	5750	10450	7000
315 ML ₋	6650	4300	10500	7050	12900	7800	13400	8300	5300	2900	8300	4900	10350	5250	11600	5400
315 LK ₋	7100	3350	11100	5850	13700	6100	14900	8300	5750	2450	8900	3700	11100	3550	12100	5450
355 SM ₋	6350	4250	13250	8600	15650	9580	17350	12500	4950	2900	10450	5850	12350	6270	13600	8900
355 ML ₋	7100	3700	14600	7950	18050	8600	21100	11650	5750	2350	11850	5150	14700	5300	17000	7600
355 LK ₋	7500	3150	15650	6600	19100	7050	21200	8700	6150	1800	12850	3800	15800	3750	17500	5000
400 LK ₋	8650	2150	16050	6400	18450	6750	20100	8350	7220)	13150	3400	15100	3400	16450	4700
400 L ₋	8650	2150	16050	6400	18450	6750	20100	8350	7220)	13150	3400	15100	3400	16450	4700

) On request

Aluminum motors

Permissible radial forces according to L₁₀ principle

Motors sizes 63 to 132

Motor size	No. of poles	Length of shaft extension E (mm)	Ball bearings							
			Basic design with deep groove ball bearings				Alternative design with 63-series bearings			
			25,000 hours		40,000 hours		25,000 hours		40,000 hours	
FX ₀ (N)	FX _{max} (N)	F _{X0} (N)	FX _{max} (N)	FX ₀ (N)	FX _{max} (N)	FX ₀ (N)	FX _{max} (N)			
63	2-8	23	490	400	490	400				
71	2-8	30	680	570	680	570				
80	2-8	40	930	750	930	750				
90	2-8	50	1010	810	1010	810				
100	2-8	60	2280	1800	2280	1800				
112 M	2	60	1800	1420	1620	1280	2160	1700	2160	1700
	4	60	1790	1410	1590	1250	2160	1700	2160	1700
	6	60	1910	1510	1700	1340	2160	1700	2160	1700
	8	60	1940	1530	1720	1360	2160	1700	2160	1700
112 MB	2	60	1820	1470	1640	1330	2100	1700	2100	1700
	4	60	1770	1430	1560	1260	2100	1700	2100	1700
	6	60	1880	1520	1650	1340	2100	1700	2100	1700
	8	60	1930	1560	1690	1370	1700	2100	1700	2100
132 SA	2	80	3020	2360	2740	2140	4070	3180	3670	2870
132 SB	2	80	3020	2360	2730	2130	4060	3170	3670	2870
132 SC	2	80	3030	2430	2750	2200	3990	3200	3690	2960
132 S	4	80	3120	2440	2790	2180	4090	3200	3830	2990
132 M	4	80	3080	2410	2750	2150	4100	3200	3780	2950
132 MB	4	80	3050	2440	2710	2170	3990	3200	3740	3000
132 S	6	80	3280	2560	2910	2270	4100	3200	3990	3120
132 MA	6	80	3240	2530	2880	2250	4100	3200	3970	3100
132 MB	6	80	3200	2500	2840	2220	4100	3200	3930	3070
132 MC	6	80	3010	2510	2660	2220	3840	3200	3700	3090
132 S	8	80	3370	2630	2980	2330	4100	3200	4100	3200
132 M	8	80	3310	2590	2940	2300	4100	3200	4060	3170
132 MB	8	80	3280	2630	2910	2330	3990	3200	3990	3200

Motors sizes 160 to 280

Motor size	No. of poles	Length of shaft extension E (mm)	Ball bearings				Roller bearings			
			Basic design with deep groove ball bearings				Alternative design with roller bearings			
			25,000 hours		40,000 hours		25,000 hours		40,000 hours	
FX ₀ (N)	FX _{max} (N)	FX ₀ (N)	FX _{max} (N)	FX ₀ (N)	FX _{max} (N)	FX ₀ (N)	FX _{max} (N)			
160	2	110	4760	3860	4100	3320	6580	4300	5620	4300
	4	110	5180	4200	4380	3545	7340	4300	6180	4300
	6	110	5160	4180	4360	3540	7780	4300	6500	4300
	8	110	6280	4300	5320	4300	8860	4300	7440	4300
180	2	110	6060	4960	5280 ¹⁾	4305 ¹⁾	7600	5500	6560	5500
	4	110	4800	3940	4020	3300	7280	5500	6140	5500
	6	110	6280	5140	5280	4380	8680	5500	7280	5500
	8	110	6960	5500	5880	4800	9440	5500	7920	5500
200	2	110	7800	6500	6760 ²⁾	5640 ²⁾	10360	8640	8880	7400
	4	110	8400	7020	7180	5980	11560	9550	9800	8180
	6	110	8960	7480	7600	6340	12480	9550	10520	8780
	8	110	10480	8740	8940	7400	14100	9550	11920	9550
225	2	110	8520	7180	7360 ³⁾	6200 ³⁾	12320	10380	10560	8900
	4	140	8380	6780	7200	5820	13380	10250	11320	9160
	6	140	10960	8860	9360	7560	15860	10250	13420	10250
	8	140	12100	9780	10340	8360	17220	10250	14580	10250
250	2	140	10480 ⁴⁾	8500 ⁴⁾	9080 ⁴⁾	7360 ⁴⁾	16220	10900	13960	10900
	4	140	10840	8780	9380	7600	18020	13800	15320	13800
	6	140	12600	10220	10700	8680	20240	13800	17140	13800
	8	140	14660	11880	12540	10160	22680	13800	19220	13800
280	2	140	6780	5500	5680	4600	16280	13200	14000	11360
	4	140	8060	6540	6640	5380	19480	15780	16540	13400
	6	140	8980	7280	7360	5960	21920	17760	18580	15060
	8	140	9180	7460	7460	6060	22240	18020	18860	15300

¹⁾ The maximum lifetime of the grease is 38 000 h

²⁾ The maximum lifetime of the grease is 27 000 h

³⁾ The maximum lifetime of the grease is 23 000 h

⁴⁾ The maximum lifetime of the grease is 16 000 h

Permissible axial forces according to L_{10} principle

The following tables give the permissible axial forces in Newton, assuming zero radial force. The values are based on normal conditions at 50 Hz with standard bearings and calculated bearing lives of 20,000 and 40,000 hours.

At 60 Hz the values are to be reduced by 10%.

For two-speed motors, the values are to be based on the higher speed. The permissible loads of simultaneous radial and axial forces will be supplied on request.

Given axial forces F_{AD} , assumes D-bearing locked by means of locking ring. Without locking ring the F_{AD} forces should be reduced to 70% of list value.

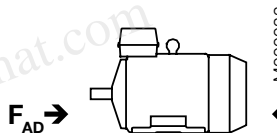

Aluminum motors, motor sizes 63 - 280

Mounting arrangement IM B3

Motor size	20,000 hours								40,000 hours							
	2-pole		4-pole		6-pole		8-pole		2-pole		4-pole		6-pole		8-pole	
	F_{AD}	F_{AZ}	F_{AD}	F_{AZ}	F_{AD}	F_{AZ}	F_{AD}	F_{AZ}	F_{AD}	F_{AZ}	F_{AD}	F_{AZ}	F_{AD}	F_{AZ}	F_{AD}	F_{AZ}
63	480	125	565	165	580	190	590	195	420	105	470	115	490	145	590	205
71	625	325	780	480	890	590	985	685	515	215	630	330	710	410	780	480
80	810	470	1015	675	1170	830	1300	960	650	315	810	470	925	595	1015	675
90	885	485	1170	650	1270	870	1410	1010	720	320	945	425	1005	605	1110	710
100	1620	1120	2065	1565	2390	1890	2660	2160	1280	780	1615	1115	1860	1360	2065	1565
112 M	-	-	-	-	-	-	2655	2155	-	-	-	-	-	-	2060	1560
112 MB	1615	1115	2060	1560	2385	1885	2655	2155	1275	775	1610	1110	1860	1360	2060	1560
132 M	-	-	2245	1645	-	-	2875	2270	-	-	1760	1160	-	-	2240	1640
132 MA	-	-	2245	1645	2595	1995	-	-	-	-	1760	1160	2025	1425	-	-
132 MC	-	-	-	-	2580	1980	-	-	-	-	-	-	2010	1410	-	-
132 MBA	-	-	2235	1635	-	-	-	-	-	-	1750	1150	-	-	-	-
132 S	-	-	-	-	2600	2000	2885	2285	-	-	-	-	2030	1435	2245	1645
132 SA	-	-	-	-	-	-	-	-	-	-	-	-	-	-	-	-
132 SB	1770	1170	-	-	-	-	-	-	1400	800	-	-	-	-	-	-
132 SBB	1760	1160	-	-	-	-	-	-	1395	795	-	-	-	-	-	-
132 SC	1760	1160	-	-	-	-	-	-	1395	795	-	-	-	-	-	-
132 SMA	-	-	-	-	-	-	-	-	-	-	-	-	-	-	-	-
132 SMB	2220	1620	2840	2240	-	-	-	-	1740	1140	2205	1605	-	-	-	-
132 SMC	2220	1620	-	-	-	-	-	-	1740	1140	-	-	-	-	-	-
132 SMD	-	-	2830	2200	-	-	-	-	-	-	2230	1595	-	-	-	-
132 SME	2210	1610	-	-	-	-	-	-	1730	1130	-	-	-	-	-	-
160	4160	4160	4740	4740	4840	4840	5980	5980	3425	3425	3920	3920	4000	4000	4920	4920
180	5480	5480	4360	4360	5980	5980	6000	6620	4600 ¹⁾	4600 ¹⁾	3540	3540	4940	4940	5460	5460
200	5000	6880	5000	7660	5000	8300	5000	9880	5000 ²⁾	5700 ²⁾	5000	6340	5000	6880	5000	8160
225	5000	7380	5000	7600	5000	10140	5000	11420	5000 ³⁾	6120 ³⁾	5000	6220	5000	8420	5000	9460
250	6000 ⁴⁾	9020 ⁴⁾	6000	9800	6000	11520	6000	13700	6000 ⁴⁾	7500 ⁴⁾	6000	8040	6000	9520	6000	11380
280	5260	5260	6500	6500	7500	7500	7740	7740	4220	4220	5160	5160	6040	6040	6180	6180

¹⁾ The maximum lifetime of the grease is 38 000 h

²⁾ The maximum lifetime of the grease is 27 000 h

³⁾ The maximum lifetime of the grease is 23 000 h

⁴⁾ The maximum lifetime of the grease is 16 000 h

Permissible axial forces according to L_{10} principle

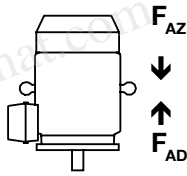

M000023

Aluminum motors, motor sizes 63 - 280

Mounting arrangement IM B5

Motor size	20,000 hours								40,000 hours							
	2-pole		4-pole		6-pole		8-pole		2-pole		4-pole		6-pole		8-pole	
	F_{AD} N	F_{AZ} N	F_{AD} N	F_{AZ} N	F_{AD} N	F_{AZ} N	F_{AD} N	F_{AZ} N	F_{AD} N	F_{AZ} N	F_{AD} N	F_{AZ} N	F_{AD} N	F_{AZ} N	F_{AD} N	F_{AZ} N
63	495	115	585	155	600	180	-	-	440	95	490	105	550	115	-	-
71	640	315	800	470	925	570	1020	665	530	200	650	320	745	390	815	455
80	845	450	1075	640	1225	795	1350	925	690	290	865	430	980	550	1070	645
90	945	450	1245	600	1360	815	1485	960	775	280	1020	375	1095	550	1185	660
100	1710	1060	2180	1485	2510	1815	2780	2080	1370	715	1735	1035	1980	1285	2185	1485
112 M	-	-	-	-	-	-	2790	2070	-	-	-	-	-	-	2195	1475
112 MB	1725	1040	2210	1460	2540	1785	2810	2055	1385	700	1110	1010	2010	1260	2210	1460
132 M	-	-	2460	1505	-	-	3130	2115	-	-	1970	1015	-	-	2490	1470
132 MA	-	-	2460	1505	2815	1850	-	-	-	-	1970	1015	2245	1280	-	-
132 MC	-	-	-	-	2885	1780	-	-	-	-	-	-	2315	1210	-	-
132 MBA	-	-	2495	1465	-	-	-	-	-	-	2010	980	-	-	-	-
132 S	-	-	-	-	2780	1885	3100	2145	-	-	-	-	2210	1315	2460	1505
132 SA	-	-	-	-	-	-	-	-	-	-	-	-	-	-	-	-
132 SB	1910	1075	-	-	-	-	-	-	1540	705	-	-	-	-	-	-
132 SBB	1950	1050	-	-	-	-	-	-	1580	670	-	-	-	-	-	-
132 SC	1945	1045	-	-	-	-	-	-	1575	670	-	-	-	-	-	-
132 SMA	-	-	-	-	-	-	-	-	-	-	-	-	-	-	-	-
132 SMB	2435	1480	3150	2035	-	-	-	-	1950	995	2515	1400	-	-	-	-
132 SMC	2445	1470	-	-	-	-	-	-	1960	985	-	-	-	-	-	-
132 SMD	-	-	3195	1995	-	-	-	-	-	-	2560	1355	-	-	-	-
132 SME	2490	1425	-	-	-	-	-	-	2005	940	-	-	-	-	-	-
160	4560	3810	5260	4310	5400	4420	6560	5580	3860	3110	4440	3490	4540	3560	5460	4480
180	5920	5115	5080	3860	6000	5445	6000	6120	5060 ¹⁾	4255 ¹⁾	4240	3020	5600	4385	6000	4900
200	5000	6350	5000	6950	5000	7505	5000	9215	5000 ²⁾	5230 ²⁾	5000	5650	5000	6025	5000	7435
225	5000	6770	5000	6795	5000	9270	5000	10595	5000 ³⁾	5490 ³⁾	5000	5475	5000	7490	5000	8535
250	6000 ⁴⁾	8335 ⁴⁾	6000	8820	6000	10275	6000	12645	6000 ⁴⁾	6755 ⁴⁾	6000	7120	6000	8235	6000	10205
280	6400	4400	7920	5400	8500	6180	8500	6435	5420	3420	6640	4120	7840	4640	7980	4775

¹⁾ The maximum lifetime of the grease is 38 000 h.
²⁾ The maximum lifetime of the grease is 27 000 h.
³⁾ The maximum lifetime of the grease is 23 000 h.
⁴⁾ The maximum lifetime of the grease is 16 000 h.

Rating plates

The rating plates are in table form giving values for speed, current and power factor for three voltages for cast iron motors : 400V-415V-690V as standard. For aluminum motors there are one or 2 voltages in use ; 230V-400V depending on the frame size. Other voltage and frequency combinations are possible and can be ordered with variant codes 002 or 209. Please see Variant code section.

The following information will be shown on the motor rating plate according to IEC 60034-30:2008:

- Lowest nominal efficiency at 100%, 75% and 50% rated load
- Efficiency level
- Year of manufacture
- Type of protection
- Apparatus group
- Temperature class
- Identification number of the certification body
- Certificate number : for cast iron motors both ATEX and IECEx are stamped on the rating plate as standard. For aluminum motors self certification.

Cast iron motors

ABB Oy, Motors Vaasa, Finland						
CE		IE2		Ex II 3G		
3 ~ Motor M3GP 225SMC 4 IMB3/IM1001						
Ex nA II T3						
414141-45		2010		No. 3GF1000005		
		Ins.cl.		F		IP 55
V	Hz	kW	r/min	A	cos φ	Duty
690 Y	50	45	1477	45	0.88	S1
400 D	50	45	1477	78	0.88	S1
415 D	50	45	1479	77	0.86	S1
IE2 - 94.1% (100%) - 94.6% (75%) - 94.4% (50%)						
Prod. code 3GGP222230-ADG						
LCIE 06 ATEX 6089 / IECEx LCI 07.0001						
		Nmax		r/min		
6313/C3		6312/C3		405 kg		
		ABB		IEC 60034-1		

M000736

Aluminum motors, sizes 63-80

Asea Brown Boveri, S.A.						
C/ Illa de Buda, 55. 08192 Sant Quirze del Vallès (Barcelona), Spain						
3~Motor M3AAD 80 C 2		IM1001		Ex tD A22 T125°C		
3GAA081313-ASE		No. 3GE101508P0012		Cl. F IP 55		
6204-2Z/C3		6203-2Z/C3		2010		11 kg
V	Hz	r/min	kW	A	Cos φ	
230 D	50	2880	1,1	3,9	0,81	
400 Y	50	2880	1,1	2,3	0,81	
IE2-82,1(100%)-82,0(75%)-79,2(50%)						
IEC 60034-1						

M000702

Aluminum motors, sizes 90-132

Asea Brown Boveri, S.A. IE2 CE						
C/ Illa de Buda, 55. 08192 Sant Quirze del Vallès (Barcelona), Spain						
3~ Motor M3AAD 90 L 4		CL. F		IP 55		IEC60034-1
3GAA092002-ADE		N° 3GE102509P3666				
V	Hz	r/min	kW	A	Cos φ	
400 D	50	1420	1,5	3,5	0,75	
LOM 99 ATEX 2025						
IE2-81,3(100%)-81,9(75%)-80,1(50%)						
		II 2D 2010		16 kg		
		6205-2RS1/C3		6204-2RS1/C3		
		0163		Ex tD A21 T125°C		

M000703

Ordering information

Sample order

When placing an order, please state the following minimum data in the order, as in example.

The product code of the motor is composed in accordance with the following example.

Motor type	M3GP 160 MLA
Pole number	2
Mounting arrangement (IM code)	IM B3 (IM 1001)
Rated output	11 kW
Product code	3GGP161410-ADH
Variant codes if needed	

Motor size

A	B	C	D.E.F.	G														
M3GP 160 MLA 3GGP 161 410 - A D H 002 etc.																		
<table style="width: 100%; border-collapse: collapse;"> <tr> <td style="border: 1px solid black; width: 20px; text-align: center;">1</td> <td style="border: 1px solid black; width: 20px; text-align: center;">2</td> <td style="border: 1px solid black; width: 20px; text-align: center;">3</td> <td style="border: 1px solid black; width: 20px; text-align: center;">4</td> <td style="border: 1px solid black; width: 20px; text-align: center;">5</td> <td style="border: 1px solid black; width: 20px; text-align: center;">6</td> <td style="border: 1px solid black; width: 20px; text-align: center;">7</td> <td style="border: 1px solid black; width: 20px; text-align: center;">8</td> <td style="border: 1px solid black; width: 20px; text-align: center;">9</td> <td style="border: 1px solid black; width: 20px; text-align: center;">10</td> <td style="border: 1px solid black; width: 20px; text-align: center;">11</td> <td style="border: 1px solid black; width: 20px; text-align: center;">12</td> <td style="border: 1px solid black; width: 20px; text-align: center;">13</td> <td style="border: 1px solid black; width: 20px; text-align: center;">14</td> </tr> </table>					1	2	3	4	5	6	7	8	9	10	11	12	13	14
1	2	3	4	5	6	7	8	9	10	11	12	13	14					
A Motor type		C Product code	E Voltage and frequency code	G Variant codes														
B Motor size		D Mounting arrangement code	F Generation code															

Explanation of the product code:

Positions 1 to 4

3GGP = Totally enclosed fan cooled squirrel cage motor with cast iron frame, dust ignition proof

3GAA = Totally enclosed fan cooled squirrel cage motor with aluminum frame, dust ignition proof

Positions 5 and 6

IEC-frame

06 = 63	20 = 200
07 = 71	22 = 225
08 = 80	25 = 250
09 = 90	28 = 280
10 = 100	31 = 315
11 = 112	35 = 355
13 = 132	40 = 400
16 = 160	
18 = 180	

Position 7

Speed (Pole pairs)

1 = 2 poles
2 = 4 poles
3 = 6 poles
4 = 8 poles
5 = 10 poles

Position 8 to 10

Serial number

Position 11

- (dash)

Position 12

Mounting arrangement

A = Foot-mounted, top-mounted terminal box

R = Foot-mounted, terminal box RHS seen from D-end

L = Foot-mounted, terminal box LHS seen from D-end

B = Flange-mounted, large flange

C = Flange-mounted, small flange (sizes 71 to 112)

H = Foot- and flange-mounted, terminal box top-mounted

J = Foot- and flange-mounted, small flange with tapped holes

S = Foot- and flange-mounted, terminal box RHS seen from D-end

T = Foot- and flange-mounted, terminal box LHS seen from D-end

V = Flange-mounted, special flange

F = Foot- and flange-mounted. Special flange

Position 13

Voltage and frequency

Single-speed motors

B 380 VΔ 50 Hz

D 400 VΔ, 415 VΔ, 690 VY 50 Hz

E 500 VΔ 50 Hz

F 500 VY 50 Hz

S 230 VΔ, 400 VY, 415 VY 50 Hz

T 660 VΔ 50 Hz

U 690 VΔ 50 Hz

X Other rated voltage, connection or frequency, 690 V maximum

Position 14

Generation code

G, H...

The product code must be, if needed, followed by variant codes.

Dust ignition proof cast iron motors

IE2

Technical data for Category 2 D - T = 125°C - IP 65



IP 65 - IC 411 - Insulation class F, temperature rise class B
IE2 efficiency class according to IEC 60034-30; 2008

Output kW	Motor type	Product code	Speed r/min	Efficiency IEC 60034-2-1; 2007			Power factor cos φ	Current			Torque			Moment of inertia J = 1/4 GD ² kgm ²	Weight kg	Sound pressure level L _{PA} dB	
				Full load 100%	3/4 load 75%	1/2 load 50%		I _N A	I _s A	T _N Nm	T _I Nm	T _b Nm					
3000 r/min = 2-poles			400 V 50 Hz				GENELEC-design										
0.75	M3GP	80 MA	3GGP 081 310-••	5)													
1.1	M3GP	80 MB	3GGP 081 320-••	5)													
1.5	M3GP	90 SLA	3GGP 091 010-••	5)													
2.2	M3GP	90 SLC	3GGP 091 030-••	5)													
3	M3GP	100 LA	3GGP 101 510-••	5)													
4	M3GP	112 MB	3GGP 111 320-••	5)													
5.5	M3GP	132 SMB	3GGP 131 220-••	5)													
7.5	M3GP	132 SMD	3GGP 131 240-••	5)													
11	M3GP	160 MLA	3GGP 161 410-••H	2931	90.1	90.5	89.6	0.89	19.7	7.2	35.8	2.6	3.1	0.0	207	71	
15	M3GP	160 MLB	3GGP 161 420-••H	2929	91.2	91.9	91.4	0.89	26.6	7.2	48.9	3.0	3.5	0.1	216	71	
18.5	M3GP	160 MLC	3GGP 161 430-••H	2934	91.8	92.2	91.8	0.90	32.3	7.5	60.2	2.8	3.4	0.1	227	69	
22	M3GP	180 MLA	3GGP 181 410-••H	2938	91.7	92.2	91.7	0.90	38.4	7.0	71.5	2.5	3.1	0.1	259	69	
30	M3GP	200 MLA	3GGP 201 410-••G	2956	93.2	93.6	93.0	0.88	52.7	7.4	96.9	3.0	3.2	0.2	275	74	
37	M3GP	200 MLC	3GGP 201 430-••G	2954	93.6	94.0	93.4	0.89	64.1	7.5	119.0	2.8	3.2	0.2	305	75	
45	M3GP	225 SMB	3GGP 221 220-••G	2968	93.9	93.8	92.9	0.87	79.5	7.2	144.0	2.7	3.0	0.3	365	76	
55	M3GP	250 SMA	3GGP 251 210-••G	2975	94.3	94.1	93.0	0.89	94.5	7.8	176.0	2.4	3.1	0.5	425	75	
75	M3GP	280 SMA	3GGP 281 210-••G	2978	94.3	94.1	92.8	0.88	130	7.6	240.0	2.1	3.0	0.8	625	77	
90	M3GP	280 SMB	3GGP 281 220-••G	2976	94.6	94.5	93.5	0.90	152	7.4	288.0	2.1	2.9	0.9	665	77	
110	M3GP	315 SMA	3GGP 311 210-••G	2982	94.9	94.4	92.9	0.86	194	7.6	352.0	2.0	3.0	1.2	880	78	
132	M3GP	315 SMB	3GGP 311 220-••G	2982	95.1	94.8	93.6	0.88	227	7.4	422.0	2.2	3.0	1.4	940	78	
160	M3GP	315 SMC	3GGP 311 230-••G	2981	95.4	95.2	94.2	0.89	271	7.5	512.0	2.3	3.0	1.7	1025	78	
200	M3GP	315 MLA	3GGP 311 410-••G	2980	95.7	95.7	94.9	0.90	335	7.7	640.0	2.6	3.0	2.1	1190	78	
250	2)	M3GP	355 SMA	3GGP 351 210-••G	2984	95.7	95.5	94.5	0.89	423	7.7	800.0	2.1	3.3	3.0	1600	83
315	2)	M3GP	355 SMB	3GGP 351 220-••G	2980	95.7	95.7	95.1	0.89	533	7.0	1009.0	2.1	3.0	3.4	1680	83
355	2)	M3GP	355 SMC	3GGP 351 230-••G	2984	95.7	95.7	95.2	0.88	608	7.2	1136.0	2.2	3.0	3.6	1750	83
400	2)	M3GP	355 MLA	3GGP 351 410-••G	2982	96.9	96.6	95.9	0.88	677	7.1	1280.0	2.3	2.9	4.1	2000	83
450	2)	M3GP	355 MLB	3GGP 351 420-••G	2983	97.1	97.0	96.4	0.90	743	7.9	1440.0	2.2	2.9	4.3	2080	83
500	2)	M3GP	355 LKA	3GGP 351 810-••G	2982	96.9	96.9	96.5	0.90	827	7.5	1601.0	2.0	3.9	4.8	2320	83
560	2)	M3GP	355 LKB	3GGP 351 820-••G	2983	97.0	97.0	96.5	0.90	925	8.0	1792.0	2.2	4.1	5.2	2460	83
560	3)	M3GP	400 LA	3GGP 401 510-••G	2988	97.2	97.2	96.6	0.89	934	7.8	1789.0	2.1	3.4	7.9	2950	82
560		M3GP	400 LKA	3GGP 401 810-••G	2988	97.2	97.2	96.6	0.89	934	7.8	1789.0	2.1	3.4	7.9	2950	82
630		M3GP	400 LB	3GGP 401 520-••G	2987	97.4	97.4	96.9	0.89	1048	7.8	2014.0	2.2	3.4	8.2	3050	82
630		M3GP	400 LKB	3GGP 401 820-••G	2987	97.4	97.4	96.9	0.89	1048	7.8	2014.0	2.2	3.4	8.2	3050	82
710		M3GP	400 LC	3GGP 401 530-••G	2987	97.5	97.4	97.0	0.89	1180	7.8	2269.0	2.6	3.4	9.3	3300	82
710	3)	M3GP	400 LKC	3GGP 401 830-••G	2987	97.5	97.4	97.0	0.89	1180	7.8	2269.0	2.6	3.4	9.3	3300	82
3000 r/min = 2-poles			400 V 50 Hz				High-output design										
22	1)	M3GP	160 MLD	3GGP 161 440-••H	2929	91.2	91.6	91.0	0.90	38.6	7.3	71.7	2.7	3.4	0.1	233	77
30		M3GP	180 MLB	3GGP 181 420-••H	2943	92.5	93.0	92.6	0.90	52	6.8	97.3	2.3	3.1	0.1	292	78
37		M3GP	180 MLC	3GGP 181 430-••H	2947	92.8	93.0	92.5	0.90	63.9	7.9	119.0	2.9	3.6	0.1	292	77
45	4)	M3GP	200 MLE	3GGP 201 450-••G	2944	93.3	93.6	93.0	0.88	79.1	7.3	145.0	2.9	3.1	0.2	310	79
55		M3GP	225 SMC	3GGP 221 230-••G	2965	93.9	93.9	92.9	0.88	96	7.1	177.0	2.6	3.0	0.3	385	80
67	4)	M3GP	225 SMD	3GGP 221 240-••G	2966	93.9	93.7	92.6	0.86	119	7.4	215.0	2.8	3.2	0.3	395	78
75		M3GP	250 SMB	3GGP 251 220-••G	2969	94.0	94.0	93.2	0.89	129	7.9	241.0	2.6	3.2	0.6	465	80
110		M3GP	280 SMC	3GGP 281 230-••G	2978	95.1	95.0	94.2	0.90	185	7.9	352.0	2.4	3.0	1.2	725	77

¹⁾ Efficiency class IE1

²⁾ 3dB(A) sound pressure level reduction with unidirectional fan construction. Direction of rotation must be stated when ordering, see variant codes 044 and 045

³⁾ Unidirectional fan construction as standard. Direction of rotation must be stated when ordering, see variant codes 044 and 045

⁴⁾ For 400-415 V 50 Hz (380 V 50 Hz voltage code B)

⁵⁾ Missing data on request

The two bullets in the product code indicate choice of mounting arrangements, voltage and frequency code (see ordering information page).

I_s / I_N = Starting current
 T_I / T_N = Locked rotor torque
 T_b / T_N = Pull-out torque

Efficiency values are given according to IEC 60034-2-1; 2007. Please note that the values are not comparable without knowing the testing method. ABB has calculated the efficiency values according to indirect method, stray load losses (additional losses) determined from measuring.

Dust ignition proof cast iron motors

IE2

Technical data for Category 2 D - T = 125°C - IP 65



IP 65 - IC 411 - Insulation class F, temperature rise class B
IE2 efficiency class according to IEC 60034-30; 2008

Output kW	Motor type	Product code	Speed r/min	Efficiency IEC 60034-2-1; 2007			Power factor cos φ	Current			Torque			Moment of inertia J = 1/4 GD ² kgm ²	Weight kg	Sound pressure level L _{PA} dB
				Full load 100%	3/4 load 75%	1/2 load 50%		I _N A	I _s A	T _N Nm	T _l Nm	T _b Nm				
1500 r/min = 4-poles		400 V 50 Hz	GENELEC-design													
0.55	M3GP 80 MA	3GGP 082 310-••	4) ¹													
0.75	M3GP 80 MB	3GGP 082 320-••	4)													
1.1	M3GP 90 SLA	3GGP 092 010-••	4)													
1.5	M3GP 90 SLC	3GGP 092 030-••	4)													
2.2	M3GP 100 LA	3GGP 102 510-••	4)													
3	M3GP 100 LB	3GGP 102 520-••	4)													
4	M3GP 112 MC	3GGP 112 330-••	4)													
5.5	M3GP 132 SMB	3GGP 132 220-••	4)													
7.5	M3GP 132 SMD	3GGP 132 240-••	4)													
11	M3GP 160 MLC	3GGP 162 430-••H	1470	91.2	91.5	90.6	0.82	21.2	7.8	71.4	3.0	3.5	0.1	226	62	
15	M3GP 160 MLE	3GGP 162 450-••H	1467	92.0	92.4	92.1	0.84	28.0	7.8	97.6	3.0	3.4	0.1	249	61	
18.5	M3GP 180 MLA	3GGP 182 410-••H	1474	91.6	92.0	91.2	0.83	35.1	7.2	119.0	2.6	3.1	0.2	271	62	
22	M3GP 180 MLB	3GGP 182 420-••H	1471	91.6	92.4	92.2	0.83	41.7	6.8	142.0	2.5	3.0	0.2	279	62	
30	M3GP 200 MLB	3GGP 202 420-••G	1475	93.6	94.0	93.7	0.85	54.4	7.4	194.0	3.0	2.8	0.3	305	61	
37	M3GP 225 SMB	3GGP 222 220-••G	1480	93.6	93.9	93.4	0.85	67.1	7.6	238.0	3.2	2.9	0.4	355	67	
45	M3GP 225 SMC	3GGP 222 230-••G	1477	94.1	94.6	94.4	0.88	78.4	7.6	290.0	3.2	2.7	0.5	390	67	
55	M3GP 250 SMA	3GGP 252 210-••G	1479	94.3	94.3	93.6	0.84	100	7.2	355.0	2.5	3.1	0.7	415	66	
75	M3GP 280 SMA	3GGP 282 210-••G	1484	94.5	94.5	93.9	0.85	134	6.9	482.0	2.5	2.8	1.3	625	68	
90	M3GP 280 SMB	3GGP 282 220-••G	1483	94.7	94.8	94.4	0.86	159	7.2	579.0	2.5	2.7	1.5	665	68	
110	M3GP 315 SMA	3GGP 312 210-••G	1487	95.1	95.1	94.3	0.86	194	7.2	706.0	2.0	2.5	2.3	900	70	
132	M3GP 315 SMB	3GGP 312 220-••G	1487	95.4	95.4	94.7	0.86	232	7.1	847.0	2.3	2.7	2.6	960	70	
160	M3GP 315 SMC	3GGP 312 230-••G	1487	95.6	95.6	95.1	0.85	284	7.2	1027.0	2.4	2.9	2.9	1000	70	
200	M3GP 315 MLA	3GGP 312 410-••G	1486	95.6	95.6	95.3	0.86	351	7.2	1285.0	2.5	2.9	3.5	1160	70	
250	M3GP 355 SMA	3GGP 352 210-••G	1488	95.9	95.9	95.5	0.86	437	7.1	1604.0	2.3	2.7	5.9	1610	74	
315	M3GP 355 SMB	3GGP 352 220-••G	1488	95.9	95.9	95.6	0.86	551	7.3	2021.0	2.3	2.8	6.9	1780	74	
355	M3GP 355 SMC	3GGP 352 230-••G	1487	95.9	95.9	95.7	0.86	621	6.8	2279.0	2.4	2.7	7.2	1820	78	
400	M3GP 355 MLA	3GGP 352 410-••G	1489	96.3	96.3	95.9	0.85	705	6.8	2565.0	2.3	2.6	8.4	2140	78	
450	M3GP 355 MLB	3GGP 352 420-••G	1490	96.8	96.8	96.3	0.86	780	6.9	2884.0	2.3	2.9	8.4	2140	78	
500	M3GP 355 LKA	3GGP 352 810-••G	1490	97.0	97.0	96.5	0.86	865	6.8	3204.0	2.0	3.0	10.0	2500	78	
560	M3GP 400 LA	3GGP 402 510-••G	1491	96.8	96.8	96.3	0.85	982	7.4	3586.0	2.4	2.8	15.0	3200	78	
560	M3GP 400 LKA	3GGP 402 810-••G	1491	96.8	96.8	96.3	0.85	982	7.4	3586.0	2.4	2.8	15.0	3200	78	
630	M3GP 400 LB	3GGP 402 520-••G	1491	97.0	97.0	96.5	0.87	1077	7.6	4034.0	2.2	2.9	16.0	3300	78	
630	M3GP 400 LKB	3GGP 402 520-••G	1491	97.0	97.0	96.5	0.87	1077	7.6	4034.0	2.2	2.9	16.0	3300	78	
710	¹⁾ M3GP 400 LC	3GGP 402 530-••G	1491	97.1	97.1	96.6	0.86	1227	7.6	4547.0	2.4	3.0	17.0	3400	78	
710	¹⁾ M3GP 400 LKC	3GGP 402 530-••G	1491	97.1	97.1	96.6	0.86	1227	7.6	4547.0	2.4	3.0	17.0	3400	78	
1500 r/min = 4-poles		400 V 50 Hz	High-output design													
18.5	M3GP 160 MLF	3GGP 162 460-••H	1469	91.7	92.1	91.4	0.83	35	7.8	120.0	3.2	3.5	0.1	249	68	
22	²⁾ M3GP 160 MLG	3GGP 162 470-••H	1466	90.8	91.1	90.4	0.81	43.1	7.9	143.0	3.3	3.6	0.1	249	68	
30	^{1) 2)} M3GP 180 MLC	3GGP 182 430-••H	1473	92.2	92.3	91.6	0.81	57.9	7.1	194.0	2.8	3.2	0.2	298	66	
37	M3GP 200 MLC	3GGP 202 430-••G	1475	93.0	93.1	92.3	0.82	70	7.5	239.0	3.5	3.2	0.3	305	73	
55	M3GP 225 SMD	3GGP 222 240-••G	1483	94.3	94.5	93.9	0.83	101	7.4	354.0	3.4	2.9	0.6	410	68	
60	^{2) 3)} M3GP 225 SME	3GGP 222 250-••G	1479	93.6	93.7	92.9	0.84	110	8.0	387.0	3.6	3.0	0.6	410	74	
75	³⁾ M3GP 250 SMB	3GGP 252 220-••G	1476	94.3	94.5	94.2	0.86	133	7.6	485.0	2.8	3.2	0.9	470	73	
110	M3GP 280 SMC	3GGP 282 230-••G	1485	95.1	95.2	94.7	0.86	194	7.6	707.0	3.0	3.0	1.9	725	68	

¹⁾ Temperature rise class F

²⁾ Efficiency class IE1

³⁾ For 400-415 V 50 Hz (380 V 50 Hz voltage code B)

⁴⁾ Missing data on request

The two bullets in the product code indicate choice of mounting arrangements, voltage and frequency code (see ordering information page).

I_s / I_N = Starting current
 T_l / T_N = Locked rotor torque
 T_b / T_N = Pull-out torque

Efficiency values are given according to IEC 60034-2-1; 2007. Please note that the values are not comparable without knowing the testing method. ABB has calculated the efficiency values according to indirect method, stray load losses (additional losses) determined from measuring.

Dust ignition proof cast iron motors

Technical data for Category 2 D - T = 125°C - IP 65

IE2

IP 65 - IC 411 - Insulation class F, temperature rise class B
IE2 efficiency class according to IEC 60034-30; 2008



Output kW	Motor type	Product code	Speed r/min	Efficiency IEC 60034-2-1; 2007			Power factor cos φ	Current					Moment of inertia J = 1/4 GD ² kgm ²	Weight kg	Sound pressure level L _{PA} dB	
				Full load 100%	3/4 load 75%	1/2 load 50%		I _N A	I _s / I _N	T _N Nm	T _I / T _N	T _b / T _N				
1000 r/min = 6-poles 400 V 50 Hz			GENELEC-design													
0.37	M3GP 80 MA	3GGP 083 310-••	3000													
0.55	M3GP 80 MB	3GGP 083 320-••	3000													
0.75	M3GP 90 SLA	3GGP 093 010-••	3000													
1.1	M3GP 90 SLC	3GGP 093 030-••	3000													
1.5	M3GP 100 LA	3GGP 103 510-••	3000													
2.2	M3GP 112 MB	3GGP 113 320-••	3000													
3	M3GP 132 SMB	3GGP 133 220-••	3000													
4	M3GP 132 SMC	3GGP 133 230-••	3000													
5.5	M3GP 132 SMD	3GGP 133 240-••	3000													
7.5	M3GP 160 MLA	3GGP 163 410-••H	965	87.2	88.4	88.2	0.81	15.3	6.5	74.2	1.9	3.0	0.1	220	57	
11	M3GP 160 MLB	3GGP 163 420-••H	972	90.1	90.8	90.4	0.81	21.7	7.8	108.0	2.3	3.5	0.1	247	65	
15	M3GP 180 MLB	3GGP 183 420-••H	972	90.4	91.0	90.4	0.82	29.2	7.2	147.0	1.9	3.2	0.3	298	58	
18.5	M3GP 200 MLA	3GGP 203 410-••G	983	90.9	91.1	90.2	0.82	35.8	7.1	179.0	3.2	3.1	0.4	265	66	
22	M3GP 200 MLB	3GGP 203 420-••G	983	91.6	91.9	91.0	0.82	42.2	7.5	213.0	3.2	3.2	0.4	285	61	
30	M3GP 225 SMB	3GGP 223 220-••G	985	92.2	92.6	92.2	0.82	57.2	7.4	290.0	3.4	3.0	0.6	350	61	
37	M3GP 250 SMA	3GGP 253 210-••G	987	93.1	93.4	92.8	0.81	70.8	7.2	357.0	3.2	2.9	1.2	420	66	
45	M3GP 280 SMA	3GGP 283 210-••G	990	93.4	93.6	93.1	0.84	82.7	7.0	434.0	2.5	2.5	1.9	605	66	
55	M3GP 280 SMB	3GGP 283 220-••G	990	93.8	94.0	93.3	0.84	100	7.0	530.0	2.7	2.6	2.2	645	66	
75	M3GP 315 SMA	3GGP 313 210-••G	992	94.4	94.4	93.5	0.82	139	7.4	721.0	2.4	2.8	3.2	830	70	
90	M3GP 315 SMB	3GGP 313 220-••G	992	94.8	94.8	94.2	0.84	163	7.5	866.0	2.4	2.8	4.1	930	70	
110	M3GP 315 SMC	3GGP 313 230-••G	991	95.0	95.0	94.6	0.83	201	7.4	1059.0	2.5	2.9	4.9	1000	70	
132	M3GP 315 MLA	3GGP 313 410-••G	991	95.3	95.4	94.9	0.83	240	7.5	1271.0	2.7	3.0	5.8	1150	68	
160	M3GP 355 SMA	3GGP 353 210-••G	993	95.4	95.4	94.8	0.83	291	7.0	1538.0	2.0	2.6	7.9	1520	75	
200	M3GP 355 SMB	3GGP 353 220-••G	993	95.7	95.7	95.1	0.84	359	7.2	1923.0	2.2	2.7	9.7	1680	75	
250	M3GP 355 SMC	3GGP 353 230-••G	993	95.7	95.7	95.1	0.83	454	7.4	2404.0	2.6	2.9	11.3	1820	75	
315	M3GP 355 MLB	3GGP 353 420-••G	992	95.7	95.7	95.2	0.83	572	7.0	3032.0	2.5	2.7	13.5	2180	75	
355	M3GP 355 LKA	3GGP 353 810-••G	992	95.7	95.7	95.1	0.83	645	7.6	3417.0	2.7	2.9	15.5	2500	75	
400	M3GP 400 LA	3GGP 403 510-••G	993	96.2	96.3	95.8	0.82	731	7.1	3846.0	2.3	2.7	17.0	2900	76	
400	M3GP 400 LKA	3GGP 403 810-••G	993	96.2	96.3	95.8	0.82	731	7.1	3846.0	2.3	2.7	17.0	2900	76	
450	M3GP 400 LB	3GGP 403 520-••G	994	96.6	96.6	96.1	0.82	819	7.4	4323.0	2.4	2.8	20.5	3150	76	
450	M3GP 400 LKB	3GGP 403 820-••G	994	96.6	96.6	96.1	0.82	819	7.4	4323.0	2.4	2.8	20.5	3150	76	
500	M3GP 400 LC	3GGP 403 530-••G	993	96.6	96.7	96.2	0.83	900	7.2	4808.0	2.5	2.7	22.0	3300	76	
500	M3GP 400 LKC	3GGP 403 830-••G	993	96.6	96.7	96.2	0.83	900	7.2	4808.0	2.5	2.7	22.0	3300	76	
560	M3GP 400 LD	3GGP 403 540-••G	993	96.9	96.9	96.4	0.85	981	7.4	5385.0	2.4	2.8	24.0	3400	77	
560	M3GP 400 LKD	3GGP 403 840-••G	993	96.9	96.9	96.4	0.85	981	7.4	5385.0	2.4	2.8	24.0	3400	77	
1000 r/min = 6-poles 400 V 50 Hz			High-output design													
14	^{1) 2)} M3GP 160 MLC	3GGP 163 430-••H	969	89.2	89.4	88.0	0.75	30.2	7.9	137.0	2.8	3.9	0.1	247	64	
18.5	²⁾ M3GP 180 MLC	3GGP 183 430-••H	975	90.1	90.2	88.7	0.74	40	7.2	181.0	2.0	3.2	0.3	298	61	
30	²⁾ M3GP 200 MLC	3GGP 203 430-••G	983	91.6	91.7	90.5	0.80	59	7.5	291.0	3.5	3.4	0.5	305	65	
37	²⁾ M3GP 225 SMC	3GGP 223 230-••G	983	92.1	92.5	92.1	0.83	69.8	7.1	359.0	3.0	2.8	0.8	380	64	
45	M3GP 250 SMB	3GGP 253 220-••G	986	93.1	93.3	92.6	0.82	85	7.2	435.0	3.3	2.8	1.5	465	65	
75	M3GP 280 SMC	3GGP 283 230-••G	990	94.2	94.5	94.1	0.84	136	7.3	723.0	2.8	2.7	2.9	725	66	

- ¹⁾ Temperature rise class F
- ²⁾ Efficiency class IE1
- ³⁾ Missing data on request

The two bullets in the product code indicate choice of mounting arrangements, voltage and frequency code (see ordering information page).

I_s / I_N = Starting current
T_I / T_N = Locked rotor torque
T_b / T_N = Pull-out torque

Efficiency values are given according to IEC 60034-2-1; 2007. Please note that the values are not comparable without knowing the testing method. ABB has calculated the efficiency values according to indirect method, stray load losses (additional losses) determined from measuring.

Dust ignition proof cast iron motors

Technical data for Category 2 D - T = 125°C - IP 65



IP 65 - IC 411 - Insulation class F, temperature rise class B

Output kW	Motor type	Product code	Speed r/min	Efficiency IEC 60034-2-1: 2007			Power factor cos φ	Current					Moment of inertia J = 1/4 GD ² kgm ²	Weight kg	Sound pressure level L _{PA} dB
				Full load 100%	3/4 load 75%	1/2 load 50%		I _N A	I _s / I _N	T _N Nm	T _l / T _N	T _b / T _N			
750 r/min = 8-poles 400 V 50 Hz			GENELEC-design												
0.18	M3GP 80 MA	3GGP 084 310-••	722	86.7	87.4	86.6	0.71	9.3	5.4	52.9	1.7	2.8	0.1	245	59
0.25	M3GP 80 MB	3GGP 084 320-••	723	86.8	87.6	86.8	0.71	12.8	5.8	72.6	1.9	3.1	0.1	245	53
0.37	M3GP 90 SLA	3GGP 094 010-••	718	85.5	86.3	85.5	0.70	18	5.7	99.7	2.1	3.1	0.1	245	55
0.55	M3GP 90 SLC	3GGP 094 030-••	723	88.3	89.2	88.7	0.72	24.9	5.7	145.0	1.7	2.7	0.2	292	63
0.75	M3GP 100 LA	3GGP 104 510-••	723	89.9	90.3	89.6	0.79	30.4	7.0	195.0	2.4	3.2	0.5	280	56
1.1	M3GP 100 LB	3GGP 104 520-••	723	88.3	89.2	88.7	0.72	24.9	5.7	145.0	1.7	2.7	0.2	292	63
1.5	M3GP 112 MC	3GGP 114 330-••	723	89.9	90.3	89.6	0.79	30.4	7.0	195.0	2.4	3.2	0.5	280	56
2.2	M3GP 132 SMC	3GGP 134 230-••	732	90.6	91.2	90.6	0.77	45.5	6.5	287.0	2.2	2.9	0.7	350	56
3	M3GP 132 SMD	3GGP 134 240-••	735	91.4	91.2	90.7	0.78	60.7	6.7	389.0	2.0	2.9	1.3	420	56
4	M3GP 160 MLA	3GGP 164 410-••H	741	92.7	92.7	91.6	0.78	73.8	7.3	476.0	1.7	3.0	1.9	605	65
5.5	M3GP 160 MLB	3GGP 164 420-••H	741	93.2	93.2	92.2	0.78	89.3	7.6	579.0	1.8	3.1	2.2	645	65
7.5	M3GP 160 MLC	3GGP 164 430-••H	742	93.4	93.5	92.7	0.81	104	7.1	707.0	1.6	2.7	3.2	830	62
11	M3GP 180 MLB	3GGP 184 420-••H	741	93.7	93.9	93.4	0.82	140	7.1	966.0	1.7	2.7	4.1	930	62
15	M3GP 200 MLA	3GGP 204 410-••G	741	94.0	94.2	93.6	0.82	168	7.4	1159.0	1.8	2.7	4.9	1000	64
18.5	M3GP 225 SMA	3GGP 224 210-••G	744	94.7	94.7	94.0	0.80	251	7.5	1694.0	1.5	2.6	7.9	1520	69
22	M3GP 225 SMB	3GGP 224 220-••G	744	95.2	95.2	94.5	0.80	303	7.6	2053.0	1.6	2.6	9.7	1680	69
30	M3GP 250 SMA	3GGP 254 210-••G	743	95.3	95.4	94.8	0.80	378	7.4	2570.0	1.6	2.6	11.3	1820	69
37	M3GP 280 SMA	3GGP 284 210-••G	743	95.4	95.5	95.0	0.80	472	7.5	3213.0	1.6	2.7	13.5	2180	72
45	M3GP 280 SMB	3GGP 284 220-••G	744	96.1	96.2	95.8	0.81	584	7.0	4043.0	1.2	2.6	17.0	2900	71
55	M3GP 315 SMA	3GGP 314 210-••G	744	96.1	96.2	95.8	0.81	584	7.0	4043.0	1.2	2.6	17.0	2900	71
75	M3GP 315 SMB	3GGP 314 220-••G	743	96.2	96.3	96.1	0.83	641	6.8	4562.0	1.2	2.5	21.0	3200	71
90	M3GP 315 SMC	3GGP 314 230-••G	743	96.2	96.3	96.1	0.83	641	6.8	4562.0	1.2	2.5	21.0	3200	71
110	M3GP 315 MLA	3GGP 314 410-••G	744	96.3	96.4	96.0	0.82	731	7.4	5134.0	1.3	2.7	24.0	3400	71
132	M3GP 355 SMA	3GGP 354 210-••G	744	96.3	96.4	96.0	0.82	731	7.4	5134.0	1.3	2.7	24.0	3400	71
160	M3GP 355 SMB	3GGP 354 220-••G	744	96.3	96.4	96.0	0.82	731	7.4	5134.0	1.3	2.7	24.0	3400	71
200	M3GP 355 SMC	3GGP 354 230-••G	744	96.3	96.4	96.0	0.82	731	7.4	5134.0	1.3	2.7	24.0	3400	71
250	M3GP 355 MLB	3GGP 354 420-••G	741	93.4	93.5	92.8	0.80	106	7.9	708.0	1.9	3.1	2.9	725	65
315	M3GP 400 LA	3GGP 404 510-••G	744	96.1	96.2	95.8	0.81	584	7.0	4043.0	1.2	2.6	17.0	2900	71
315	M3GP 400 LKA	3GGP 404 810-••G	744	96.1	96.2	95.8	0.81	584	7.0	4043.0	1.2	2.6	17.0	2900	71
355	M3GP 400 LB	3GGP 404 520-••G	743	96.2	96.3	96.1	0.83	641	6.8	4562.0	1.2	2.5	21.0	3200	71
355	M3GP 400 LKB	3GGP 404 820-••G	743	96.2	96.3	96.1	0.83	641	6.8	4562.0	1.2	2.5	21.0	3200	71
400	M3GP 400 LC	3GGP 404 530-••G	744	96.3	96.4	96.0	0.82	731	7.4	5134.0	1.3	2.7	24.0	3400	71
400	M3GP 400 LKC	3GGP 404 830-••G	744	96.3	96.4	96.0	0.82	731	7.4	5134.0	1.3	2.7	24.0	3400	71
750 r/min = 8-poles 400 V 50 Hz			High-output design												
18.5	M3GP 200 MLB	3GGP 204 420-••G	734	89.8	90.2	89.6	0.80	37.1	6.9	240.0	2.2	3.2	0.5	300	57
30	M3GP 225 SMC	3GGP 224 230-••G	731	90.7	91.5	91.3	0.78	61.2	6.3	391.0	2.3	3.0	0.8	375	59
37	M3GP 250 SMB	3GGP 254 220-••G	737	92.2	91.7	91.0	0.78	74.2	7.5	479.0	2.3	3.4	1.5	465	59
55	M3GP 280 SMC	3GGP 284 230-••G	741	93.4	93.5	92.8	0.80	106	7.9	708.0	1.9	3.1	2.9	725	65

¹⁾ Missing data on request

The two bullets in the product code indicate choice of mounting arrangements, voltage and frequency code (see ordering information page).

I_s / I_N = Starting current
T_l / T_N = Locked rotor torque
T_b / T_N = Pull-out torque

Efficiency values are given according to IEC 60034-2-1; 2007. Please note that the values are not comparable without knowing the testing method. ABB has calculated the efficiency values according to indirect method, stray load losses (additional losses) determined from measuring.

Dust ignition proof aluminum motors

IE2

Technical data for Category 2 D - T = 125°C - IP 65



IP 65 - IC 411 - Insulation class F, temperature rise class B
IE2 efficiency class according to IEC 60034-30; 2008

Output kW	Motor type	Product code	Speed r/min	Efficiency IEC 60034-2-1; 2007			Power factor cos φ	Current		Torque			Moment of inertia J = 1/4 GD ² kgm ²	Weight kg	Sound pressure level L _{PA} dB
				Full load 100%	3/4 load 75%	1/2 load 50%		I _N A	I _s I _N	T _N Nm	T _I T _N	T _b T _N			
3000 r/min = 2-poles			400 V 50 Hz			CENELEC-design									
1.5 ²⁾	M3AAD 90 S	3GAA 091 001-••E	2895	78.5	77.2	71.6	0.75	3.6	6.4	4.9	2.3	3.0	0.0019	13	63
2.2	M3AAD 90 L	3GAA 091 002-••E	2890	83.6	84.4	83.0	0.82	4.6	7.2	7.2	2.7	2.8	0.0024	16	63
3	M3AAD 100 L	3GAA 101 001-••E	2905	85.4	85.8	84.4	0.81	6.2	7.5	9.8	2.6	3.2	0.0041	21	65
4 ²⁾	M3AAD 112 M	3GAA 111 101-••E	2885	85.7	86.7	86.5	0.85	7.9	7.4	13.2	2.6	2.8	0.0061	26	67
5.5 ²⁾	M3AAD 132 SA	3GAA 131 001-••E	2845	85.8	86.4	86.0	0.87	10.6	6.8	18.4	2.8	3.2	0.014	38	75
7.5 ²⁾	M3AAD 132 SB	3GAA 131 002-••E	2860	87.0	88.0	86.0	0.89	13.9	7.2	25.0	3.0	3.4	0.016	43	73
11	M3AA 160 MLA	3GAA 161 031-••G	2938	90.7	91.5	91.1	0.91	19.2	7.5	35.7	2.4	3.1	0.044	91	69
15	M3AA 160 MLB	3GAA 161 036-••G	2934	91.5	92.5	92.2	0.91	26.0	7.5	48.8	2.5	3.3	0.053	105	69
18.5	M3AA 160 MLC	3GAA 161 037-••G	2932	92.0	93.1	93.1	0.92	31.5	7.5	60.2	2.9	3.4	0.063	123	69
22	M3AA 180 MLA	3GAA 181 031-••G	2952	92.2	92.7	92.2	0.87	39.5	7.7	71.1	2.8	3.3	0.076	132	69
30	M3AA 200 MLA	3GAA 201 035-••G	2956	93.1	93.5	92.9	0.90	51.6	7.7	96.9	2.7	3.1	0.178	210	72
37	M3AA 200 MLB	3GAA 201 036-••G	2959	93.4	93.7	93.0	0.90	63.5	8.2	119	3.0	3.3	0.196	225	72
45	M3AA 225 SMA	3GAA 221 031-••G	2961	93.6	93.9	93.1	0.88	78.8	6.7	145	2.5	2.5	0.244	263	74
55	M3AA 250 SMA	3GAA 251 031-••G	2967	94.1	94.4	93.8	0.88	95.8	6.8	177	2.2	2.7	0.507	304	75
75	M3AA 280 SMA	3GAA 281 031-••G	2968	94.5	94.8	94.3	0.89	128	7.1	241	2.5	2.8	0.583	389	75
90 ¹⁾	M3AA 280 SMB	3GAA 281 032-••G	2971	95.0	95.2	94.8	0.89	153	7.8	289	2.6	3.2	0.644	425	75
3000 r/min = 2-poles			400 V 50 Hz			High-output design									
2.7 ¹⁾²⁾	M3AAD 90 LB	3GAA 091 003-••E	2860	81.0	81.2	79.0	0.86	5.5	7.0	9.0	2.6	3.0	0.0027	18	68
4 ¹⁾²⁾	M3AAD 100 LB	3GAA 101 002-••E	2900	84.3	83.9	83.7	0.86	7.9	7.5	13.1	2.7	3.6	0.005	25	68
5.5 ¹⁾²⁾	M3AAD 112 MB	3GAA 111 102-••E	2850	86.4	87.0	87.4	0.90	10.2	7.2	18.4	3.4	3.4	0.0062	30	68
9.2 ¹⁾²⁾	M3AAD 132 SBB	3GAA 131 004-••E	2875	87.0	88.0	86.5	0.92	16.5	7.2	30.5	2.5	3.0	0.018	52	68
11 ¹⁾²⁾	M3AAD 132 SC	3GAA 131 003-••E	2890	88.7	89.5	89.3	0.89	20.1	8.1	36.3	2.8	3.4	0.018	52	68
30	M3AA 180 MLB	3GAA 181 032-••G	2950	92.8	93.5	93.3	0.88	53.0	7.9	97.1	2.8	3.3	0.092	149	69
45	M3AA 200 MLC	3GAA 201 033-••G	2957	93.3	93.8	93.2	0.88	79.1	8.1	145	3.1	3.3	0.196	225	72
55	M3AA 225 SMB	3GAA 221 032-••G	2961	93.9	94.3	93.6	0.88	96.0	6.5	177	2.4	2.5	0.274	286	74
75	M3AA 250 SMB	3GAA 251 032-••G	2970	94.6	94.9	94.4	0.89	128	7.6	241	2.8	3.1	0.583	351	75

¹⁾ Temperature rise class F

²⁾ Efficiency class IE1

The two bullets in the product code indicate choice of mounting arrangements, voltage and frequency code (see ordering information page).

I_s / I_N = Starting current
T_I / T_N = Locked rotor torque
T_b / T_N = Pull-out torque

Efficiency values are given according to IEC 60034-2-1; 2007. Please note that the values are not comparable without knowing the testing method. ABB has calculated the efficiency values according to indirect method, stray load losses (additional losses) determined from measuring.

Dust ignition proof aluminum motors

IE2

Technical data for Category 2 D - T = 125°C - IP 65



IP 65 - IC 411 - Insulation class F, temperature rise class B
IE2 efficiency class according to IEC 60034-30; 2008

Output kW	Motor type	Product code	Speed r/min	Efficiency IEC 60034-2-1; 2007			Power factor cos φ	Current		Torque			Moment of inertia J = 1/4 GD ² kgm ²	Weight kg	Sound pressure level L _{PA} dB
				Full load 100%	3/4 load 75%	1/2 load 50%		I _N A	I _s I _N	T _N Nm	T _I T _N	T _b T _N			
1500 r/min = 4-poles			400 V 50 Hz			CENELEC-design									
1.1	²⁾ M3AAD 90 S	3GAA 092 001-••E	1420	77.2	78.1	76.0	0.77	2.6	4.8	7.3	2.0	2.6	0.0032	13	50
1.5	²⁾ M3AAD 90 L	3GAA 092 002-••E	1420	81.3	81.9	80.1	0.75	3.5	5.8	10.0	2.8	3.0	0.0043	16	50
2.2	²⁾ M3AAD 100 LA	3GAA 102 001-••E	1430	82.3	83.4	82.5	0.78	4.9	5.6	14.6	2.2	2.6	0.0069	21	64
3	²⁾ M3AAD 100 LB	3GAA 102 002-••E	1430	84.6	85.7	84.2	0.78	6.5	6.4	20.0	2.5	3.0	0.0082	24	66
4	²⁾ M3AAD 112 M	3GAA 112 101-••E	1430	86.0	87.1	86.8	0.80	8.3	6.4	26.7	2.3	2.6	0.01	29	60
5.5	²⁾ M3AAD 132 S	3GAA 132 001-••E	1450	86.5	87.0	86.1	0.75	12.2	5.6	36.2	2.1	2.6	0.031	42	66
7.5	²⁾ M3AAD 132 M	3GAA 132 002-••E	1450	88.6	89.2	88.4	0.75	16.2	6.1	49.3	2.3	2.7	0.038	49	66
11	M3AA 160 MLA	3GAA 162 031-••G	1466	90.4	91.6	91.3	0.84	20.9	6.8	71.6	2.2	2.8	0.081	99	62
15	M3AA 160 MLB	3GAA 162 032-••G	1470	91.4	92.4	92.2	0.83	28.5	7.1	97.4	2.6	3.0	0.099	118	62
18.5	M3AA 180 MLA	3GAA 182 031-••G	1477	91.9	92.9	92.7	0.84	34.5	7.2	119	2.6	2.9	0.166	146	62
22	M3AA 180 MLB	3GAA 182 032-••G	1475	92.4	93.3	93.2	0.84	40.9	7.3	142	2.6	3.0	0.195	163	62
30	M3AA 200 MLA	3GAA 202 031-••G	1480	93.2	94.0	93.7	0.84	55.3	7.4	193	2.8	3.0	0.309	218	63
37	M3AA 225 SMA	3GAA 222 031-••G	1479	93.4	93.9	93.4	0.84	68.0	7.1	238	2.6	2.9	0.356	240	66
45	M3AA 225 SMB	3GAA 222 032-••G	1480	93.9	94.3	93.9	0.85	81.3	7.5	290	2.8	3.2	0.44	273	66
55	M3AA 250 SMA	3GAA 252 031-••G	1480	94.4	95.0	94.7	0.85	98.9	7.0	354	2.6	2.9	0.765	314	67
72	M3AA 280 SMA	3GAA 282 031-••G	1479	94.4	95.0	94.7	0.85	129	7.4	464	2.9	3.1	0.866	389	67
1500 r/min = 4-poles			400 V 50 Hz			High-output design									
1.85	¹⁾²⁾ M3AAD 90 L	3GAA 092 003-••E	1390	79.3	78.5	78.7	0.80	4.2	4.5	12.7	2.2	2.4	0.0043	16	50
2.2	¹⁾²⁾ M3AAD 90 LB	3GAA 092 004-••E	1390	80.0	80.9	79.5	0.83	4.7	4.5	15.1	2.2	2.4	0.0048	17	50
4	¹⁾²⁾ M3AAD 100 LC	3GAA 102 003-••E	1420	83.2	83.3	81.7	0.82	8.4	5.5	26.8	2.5	2.8	0.009	25	60
5.5	¹⁾²⁾ M3AAD 112 MB	3GAA 112 102-••E	1420	85.1	85.5	84.5	0.80	11.6	6.0	36.9	2.7	3.1	0.0126	34	64
9.2	¹⁾ M3AAD 132 MBA	3GAA 132 004-••E	1455	89.8	90.5	89.5	0.84	17.6	7.5	60.3	2.1	2.8	0.048	59	59
18.5	M3AA 160 MLC	3GAA 162 033-••G	1469	91.4	92.5	92.3	0.84	34.7	7.6	120	3.0	3.2	0.11	127	62
22	M3AA 160 MLD	3GAA 162 034-••G	1463	91.6	93.0	93.2	0.85	40.7	6.9	143	2.5	2.9	0.125	140	62
37	M3AA 200 MLB	3GAA 202 032-••G	1479	93.4	94.4	94.4	0.85	67.2	7.1	238	2.6	2.9	0.343	234	63
55	M3AA 225 SMC	3GAA 222 033-••G	1478	94.0	94.7	94.5	0.85	99.3	7.4	355	2.9	3.1	0.474	287	66
68	M3AA 250 SMB	3GAA 252 032-••G	1481	94.7	95.0	94.8	0.84	123	7.9	438	3.1	3.5	0.866	350	67

¹⁾ Temperature rise class F

²⁾ Efficiency class IE1

The two bullets in the product code indicate choice of mounting arrangements, voltage and frequency code (see ordering information page).

I_s / I_N = Starting current
T_I / T_N = Locked rotor torque
T_b / T_N = Pull-out torque

Efficiency values are given according to IEC 60034-2-1; 2007. Please note that the values are not comparable without knowing the testing method. ABB has calculated the efficiency values according to indirect method, stray load losses (additional losses) determined from measuring.

Dust ignition proof aluminum motors

IE2

Technical data for Category 2 D - T = 125°C - IP 65



IP 65 - IC 411 - Insulation class F, temperature rise class B
IE2 efficiency class according to IEC 60034-30; 2008

Output kW	Motor type	Product code	Speed r/min	Efficiency IEC 60034-2-1; 2007			Power factor cos φ	Current		Torque			Moment of inertia J = 1/4 GD ² kgm ²	Weight kg	Sound pressure level L _{PA} dB
				Full load 100%	3/4 load 75%	1/2 load 50%		I _N A	I _s I _N	T _N Nm	T _I T _N	T _b T _N			
1000 r/min = 6-poles		400 V 50 Hz		CENELEC-design											
0.75 ²⁾	M3AAD 90 S	3GAA 093 001-••E	925	71.5	70.9	65.9	0.64	2.3	3.6	7.7	2.1	2.4	0.0032	13	44
1.1	M3AAD 90 L	3GAA 093 002-••E	915	72.9	73.4	70.0	0.63	3.4	3.2	11.4	1.9	2.1	0.0043	16	44
1.5 ²⁾	M3AAD 100 L	3GAA 103 001-••E	950	79.6	79.9	77.5	0.69	3.9	4.2	15.0	2.0	2.3	0.0082	23	49
2.2	M3AAD 112 M	3GAA 113 101-••E	960	82.8	82.5	79.5	0.66	5.8	5.1	21.8	2.3	2.8	0.01	28	54
3 ²⁾	M3AAD 132 S	3GAA 133 001-••E	960	82.5	82.9	80.9	0.68	7.7	4.3	29.8	1.8	2.3	0.031	39	57
4 ²⁾	M3AAD 132 MA	3GAA 133 002-••E	965	83.6	83.2	80.8	0.65	10.6	5.1	39.5	2.1	2.5	0.038	46	61
5.5 ²⁾	M3AAD 132 MB	3GAA 133 003-••E	960	83.8	84.3	82.9	0.71	13.3	5.3	54.7	2.0	2.4	0.045	54	57
7.5	M3AA 160 MLA	3GAA 163 031-••G	975	88.6	89.9	89.7	0.79	15.4	7.4	73.4	1.7	3.2	0.087	98	59
11	M3AA 160 MLB	3GAA 163 032-••G	972	89.3	90.7	90.6	0.79	22.5	7.5	108	1.9	2.9	0.114	125	59
15	M3AA 180 MLA	3GAA 183 031-••G	981	90.5	91.4	91.0	0.77	31.0	6.5	146	1.8	2.8	0.192	162	59
18.5	M3AA 200 MLA	3GAA 203 031-••G	988	91.6	92.3	91.7	0.80	36.4	6.7	178	2.3	2.9	0.382	196	63
22	M3AA 200 MLB	3GAA 203 032-••G	987	92.0	93.0	92.8	0.82	42.0	6.6	212	2.2	2.8	0.448	218	63
30	M3AA 225 SMA	3GAA 223 031-••G	986	92.7	93.3	92.9	0.83	56.2	7.0	290	2.6	2.9	0.663	266	63
37	M3AA 250 SMA	3GAA 253 031-••G	989	93.1	93.8	93.4	0.82	69.9	6.8	357	2.4	2.7	1.13	294	63
45 ¹⁾	M3AA 280 SMA	3GAA 283 031-••G	988	92.9	93.7	93.6	0.83	84.2	6.8	434	2.4	2.6	1.369	378	63
1000 r/min = 6-poles		400 V 50 Hz		High-output design											
1.3 ¹⁾²⁾	M3AAD 90 LB	3GAA 093 003-••E	910	74.4	72.6	68.7	0.71	3.5	4.0	13.6	1.9	2.2	0.0048	18	44
2.2 ¹⁾²⁾	M3AAD 100 LC	3GAA 103 002-••E	940	78.0	74.0	71.2	0.71	5.7	4.5	22.3	1.9	2.3	0.009	26	49
3 ¹⁾²⁾	M3AAD 112 MB	3GAA 113 102-••E	920	79.7	80.5	80.3	0.75	7.2	3.8	31.1	1.9	2.2	0.0126	32	76
15 ²⁾	M3AA 160 MLC	3GAA 163 033-••G	967	88.7	90.5	90.5	0.76	32.1	6.3	148	2.0	2.9	0.131	138	59
30 ¹⁾²⁾	M3AA 200 MLC	3GAA 203 033-••G	985	91.6	92.8	92.5	0.82	57.6	6.9	290	2.3	2.8	0.531	245	63
37	M3AA 225 SMB	3GAA 223 034-••G	985	93.1	94.0	94.0	0.83	69.1	6.6	358	2.3	2.6	0.821	300	63
45	M3AA 250 SMB	3GAA 253 032-••G	989	93.4	94.1	93.9	0.83	83.7	7.0	434	2.5	2.7	1.369	341	63

¹⁾ Temperature rise class F

²⁾ Efficiency class IE1

The two bullets in the product code indicate choice of mounting arrangements, voltage and frequency code (see ordering information page).

I_s / I_N = Starting current
T_I / T_N = Locked rotor torque
T_b / T_N = Pull-out torque

Efficiency values are given according to IEC 60034-2-1; 2007. Please note that the values are not comparable without knowing the testing method. ABB has calculated the efficiency values according to indirect method, stray load losses (additional losses) determined from measuring.

Dust ignition proof aluminum motors

Technical data for Category 2 D - T = 125°C - IP 65



IP 65 - IC 411 - Insulation class F, temperature rise class B

Output kW	Motor type	Product code	Speed r/min	Efficiency IEC 60034-2-1; 2007			Power factor cos φ	Current		Torque			Moment of inertia J = 1/4 GD ² kgm ²	Weight kg	Sound pressure level L _{PA} dB
				Full load 100%	3/4 load 75%	1/2 load 50%		I _N A	I _s A	T _N Nm	T _I Nm	T _b Nm			
750 r/min = 8-poles			400 V 50 Hz			CENELEC-design									
0.37	M3AAD 90 S	3GAA 094 001-••E	695	59.4	56.3	49.1	0.54	1.66	2.7	5.0	1.6	2.1	0.0032	13	52
0.55	M3AAD 90 L	3GAA 094 002-••E	660	59.1	59.5	55.2	0.58	2.3	2.1	7.9	1.5	1.6	0.0043	16	52
0.75	M3AAD 100 LA	3GAA 104 001-••E	720	70.7	67.1	59.9	0.47	3.2	3.9	9.9	2.8	3.6	0.0069	20	46
1.1	M3AAD 100 LB	3GAA 104 002-••E	695	76.0	76.5	74.6	0.66	3.1	3.4	15.1	1.7	2.2	0.0082	23	53
1.5	M3AAD 112 M	3GAA 114 101-••E	690	74.4	75.9	74.1	0.70	4.1	3.2	20.7	1.4	1.9	0.01	28	55
2.2	M3AAD 132 S	3GAA 134 001-••E	715	82.9	83.0	80.8	0.62	6.1	3.4	29.3	1.3	1.9	0.0038	46	56
3	M3AAD 132 M	3GAA 134 002-••E	715	79.9	80.8	79.1	0.64	8.4	3.2	40.0	1.2	1.8	0.0045	53	58
4	M3AA 160 MLA	3GAA 164 031-••G	728	84.1	85.1	83.7	0.67	10.2	5.4	52.4	1.5	2.6	0.068	84	59
5.5	M3AA 160 MLB	3GAA 164 032-••G	726	84.7	86.0	84.9	0.67	13.9	5.6	72.3	1.4	2.6	0.085	98	59
7.5	M3AA 160 MLC	3GAA 164 033-••G	727	86.1	87.3	86.6	0.65	19.3	4.7	98.5	1.5	2.8	0.132	137	59
11	M3AA 180 MLA	3GAA 184 031-••G	731	86.8	88.4	87.8	0.67	27.3	4.4	143	1.8	2.6	0.214	175	59
15	M3AA 200 MLA	3GAA 204 031-••G	737	90.2	91.3	90.9	0.74	32.4	5.3	194	2.0	2.4	0.45	217	60
18.5	M3AA 225 SMA	3GAA 224 031-••G	739	91.0	92.0	91.5	0.73	40.1	5.2	239	2.0	2.3	0.669	266	63
22	M3AA 225 SMB	3GAA 224 032-••G	738	91.6	92.4	92.0	0.74	46.8	5.5	284	2.0	2.3	0.722	279	63
30	M3AA 250 SMA	3GAA 254 031-••G	742	92.4	92.9	92.3	0.71	66.0	5.8	386	2.6	2.4	1.404	340	63
37	M3AA 280 SMA	3GAA 284 031-••G	740	92.3	93.0	92.7	0.74	78.1	5.6	477	2.4	2.3	1.505	403	63
750 r/min = 8-poles			400 V 50 Hz			High-output design									
0.75	¹⁾ M3AAD 90 LB	3GAA 094 003-••E	680	63.1	59.8	53.0	0.60	2.8	3.0	10.5	1.8	2.0	0.0048	18	43
1.5	¹⁾ M3AAD 100 LC	3GAA 104 003-••E	670	70.0	65.2	63.8	0.70	4.4	3.3	21.3	1.8	2.2	0.009	26	46
2	¹⁾ M3AAD 112 MB	3GAA 114 102-••E	685	73.2	72.5	70.0	0.69	5.7	3.4	27.8	2.1	2.3	0.0126	32	52

¹⁾ Temperature rise class F

²⁾ Efficiency class IE1

The two bullets in the product code indicate choice of mounting arrangements, voltage and frequency code (see ordering information page).

I_s / I_N = Starting current
T_I / T_N = Locked rotor torque
T_b / T_N = Pull-out torque

Efficiency values are given according to IEC 60034-2-1; 2007. Please note that the values are not comparable without knowing the testing method. ABB has calculated the efficiency values according to indirect method, stray load losses (additional losses) determined from measuring.

Dust ignition proof cast iron motors

IE2

Technical data for Category 3 D - T = 125°C - IP 55



IP 55 - IC 411 - Insulation class F, temperature rise class B
IE2 efficiency class according to IEC 60034-30; 2008

Output kW	Motor type	Product code	Speed r/min	Efficiency IEC 60034-2-1; 2007			Power factor cos φ	Current			Torque			Moment of inertia J = 1/4 GD ² kgm ²	Weight kg	Sound pressure level L _{PA} dB
				Full load 100%	3/4 load 75%	1/2 load 50%		I _N A	I _s A	T _N Nm	T _I Nm	T _b Nm				
3000 r/min = 2-poles			400 V 50 Hz			CENELEC-design										
0.75	M3GP 80 MA	3GGP 081 310-••	5)													
1.1	M3GP 80 MB	3GGP 081 320-••	5)													
1.5	M3GP 90 SLA	3GGP 091 010-••	5)													
2.2	M3GP 90 SLC	3GGP 091 030-••	5)													
3	M3GP 100 LA	3GGP 101 510-••	5)													
4	M3GP 112 MB	3GGP 111 320-••	5)													
5.5	M3GP 132 SMB	3GGP 131 220-••	5)													
7.5	M3GP 132 SMD	3GGP 131 240-••	5)													
11	M3GP 160 MLA	3GGP 161 410-••H	2931	90.1	90.5	89.6	0.89	19.7	7.2	35.8	2.6	3.1	0.043	207	71	
15	M3GP 160 MLB	3GGP 161 420-••H	2929	91.2	91.9	91.4	0.89	26.6	7.2	48.9	3.0	3.5	0.052	216	71	
18.5	M3GP 160 MLC	3GGP 161 430-••H	2934	91.8	92.2	91.8	0.90	32.3	7.5	60.2	2.8	3.4	0.062	227	69	
22	M3GP 180 MLA	3GGP 181 410-••H	2938	91.7	92.2	91.7	0.90	38.4	7.0	71.5	2.5	3.1	0.089	259	69	
30	M3GP 200 MLA	3GGP 201 410-••G	2956	93.2	93.6	93.0	0.88	52.7	7.4	96.9	3.0	3.2	0.15	275	74	
37	M3GP 200 MLC	3GGP 201 430-••G	2954	93.6	94.0	93.4	0.89	64.1	7.5	119	2.8	3.2	0.19	305	75	
45	M3GP 225 SMB	3GGP 221 220-••G	2968	93.9	93.8	92.9	0.87	79.5	7.2	144	2.7	3.0	0.26	365	76	
55	M3GP 250 SMA	3GGP 251 210-••G	2975	94.3	94.1	93.0	0.89	94.5	7.8	176	2.4	3.1	0.49	425	75	
75	M3GP 280 SMA	3GGP 281 210-••G	2978	94.3	94.1	92.8	0.88	130	7.6	240	2.1	3.0	0.8	625	77	
90	M3GP 280 SMB	3GGP 281 220-••G	2976	94.6	94.5	93.5	0.90	152	7.4	288	2.1	2.9	0.9	665	77	
110	M3GP 315 SMA	3GGP 311 210-••G	2982	94.9	94.4	92.9	0.86	194	7.6	352	2.0	3.0	1.2	880	78	
132	M3GP 315 SMB	3GGP 311 220-••G	2982	95.1	94.8	93.6	0.88	227	7.4	422	2.2	3.0	1.4	940	78	
160	M3GP 315 SMC	3GGP 311 230-••G	2981	95.4	95.2	94.2	0.89	271	7.5	512	2.3	3.0	1.7	1025	78	
200	M3GP 315 MLA	3GGP 311 410-••G	2980	95.7	95.7	94.9	0.90	335	7.7	640	2.6	3.0	2.1	1190	78	
250	²⁾ M3GP 355 SMA	3GGP 351 210-••G	2984	95.7	95.5	94.5	0.89	423	7.7	800	2.1	3.3	3.0	1600	83	
315	²⁾ M3GP 355 SMB	3GGP 351 220-••G	2980	95.7	95.7	95.1	0.89	533	7.0	1009	2.1	3.0	3.4	1680	83	
355	²⁾ M3GP 355 SMC	3GGP 351 230-••G	2984	95.7	95.7	95.2	0.88	608	7.2	1136	2.2	3.0	3.6	1750	83	
400	²⁾ M3GP 355 MLA	3GGP 351 410-••G	2982	96.9	96.6	95.9	0.88	677	7.1	1280	2.3	2.9	4.1	2000	83	
450	²⁾ M3GP 355 MLB	3GGP 351 420-••G	2983	97.1	97.0	96.4	0.90	743	7.9	1440	2.2	2.9	4.3	2080	83	
500	²⁾ M3GP 355 LKA	3GGP 351 810-••G	2982	96.9	96.9	96.5	0.90	827	7.5	1601	2.0	3.9	4.8	2320	83	
560	²⁾ M3GP 355 LKB	3GGP 351 820-••G	2983	97.0	97.0	96.5	0.90	925	8.0	1792	2.2	4.1	5.2	2460	83	
560	³⁾ M3GP 400 LA	3GGP 401 510-••G	2988	97.2	97.2	96.6	0.89	934	7.8	1789	2.1	3.4	7.9	2950	82	
560	³⁾ M3GP 400 LKA	3GGP 401 810-••G	2988	97.2	97.2	96.6	0.89	934	7.8	1789	2.1	3.4	7.9	2950	82	
630	³⁾ M3GP 400 LB	3GGP 401 520-••G	2987	97.4	97.4	96.9	0.89	1048	7.8	2014	2.2	3.4	8.2	3050	82	
630	³⁾ M3GP 400 LKB	3GGP 401 820-••G	2987	97.4	97.4	96.9	0.89	1048	7.8	2014	2.2	3.4	8.2	3050	82	
710	³⁾ M3GP 400 LC	3GGP 401 530-••G	2987	97.5	97.4	97.0	0.89	1180	7.8	2269	2.6	3.4	9.3	3300	82	
710	³⁾ M3GP 400 LKC	3GGP 401 830-••G	2987	97.5	97.4	97.0	0.89	1180	7.8	2269	2.6	3.4	9.3	3300	82	
3000 r/min = 2-poles			400 V 50 Hz			High-output design										
22	¹⁾ M3GP 160 MLD	3GGP 161 440-••H	2929	91.2	91.6	91.0	0.90	38.6	7.3	71.7	2.7	3.4	0.07	233	77	
30	M3GP 180 MLB	3GGP 181 420-••H	2943	92.5	93.0	92.6	0.90	52.0	6.8	97.3	2.3	3.1	0.13	292	78	
37	M3GP 180 MLC	3GGP 181 430-••H	2947	92.8	93.0	92.5	0.90	63.9	7.9	119	2.9	3.6	0.13	292	77	
45	⁴⁾ M3GP 200 MLE	3GGP 201 450-••G	2944	93.3	93.6	93.0	0.88	79.1	7.3	145	2.9	3.1	0.22	310	79	
55	M3GP 225 SMC	3GGP 221 230-••G	2965	93.9	93.9	92.9	0.88	96.0	7.1	177	2.6	3.0	0.29	385	80	
67	⁴⁾ M3GP 225 SMD	3GGP 221 240-••G	2966	93.9	93.7	92.6	0.86	119	7.4	215	2.8	3.2	0.31	395	78	
75	M3GP 250 SMB	3GGP 251 220-••G	2969	94.0	94.0	93.2	0.89	129	7.9	241	2.6	3.2	0.57	465	80	
110	M3GP 280 SMC	3GGP 281 230-••G	2978	95.1	95.0	94.2	0.90	185	7.9	352	2.4	3.0	1.15	725	77	

¹⁾ Efficiency class IE1

²⁾ 3dB(A) sound pressure level reduction with unidirectional fan construction. Direction of rotation must be stated when ordering, see variant codes O44 and O45

³⁾ Unidirectional fan construction as standard. Direction of rotation must be stated when ordering, see variant codes O44 and O45

⁴⁾ For 400-415 V 50 Hz (380 V 50 Hz voltage code B)

⁵⁾ Missing data on request

The two bullets in the product code indicate choice of mounting arrangements, voltage and frequency code (see ordering information page).

I_s / I_N = Starting current
T_I / T_N = Locked rotor torque
T_b / T_N = Pull-out torque

Efficiency values are given according to IEC 60034-2-1; 2007. Please note that the values are not comparable without knowing the testing method. ABB has calculated the efficiency values according to indirect method, stray load losses (additional losses) determined from measuring.

Dust ignition proof cast iron motors

IE2

Technical data for Category 3 D - T = 125°C - IP 55

IP 55 - IC 411 - Insulation class F, temperature rise class B
IE2 efficiency class according to IEC 60034-30; 2008



Output kW	Motor type	Product code	Speed r/min	Efficiency IEC 60034-2-1; 2007			Power factor cos φ	Current					Moment of inertia J = 1/4 GD ² kgm ²	Weight kg	Sound pressure level L _{PA} dB
				Full load 100%	3/4 load 75%	1/2 load 50%		I _N A	I _s I _N	T _N Nm	T _I T _N	T _b T _N			
1500 r/min = 4-poles			400 V 50 Hz			CENELEC-design									
0.55	M3GP 80 MA	3GGP 082 310-••	4)												
0.75	M3GP 80 MB	3GGP 082 320-••	4)												
1.1	M3GP 90 SLA	3GGP 092 010-••	4)												
1.5	M3GP 90 SLC	3GGP 092 030-••	4)												
2.2	M3GP 100 LA	3GGP 102 510-••	4)												
3	M3GP 100 LB	3GGP 102 520-••	4)												
4	M3GP 112 MC	3GGP 112 330-••	4)												
5.5	M3GP 132 SMB	3GGP 132 220-••	4)												
7.5	M3GP 132 SMD	3GGP 132 240-••	4)												
11	M3GP 160 MLC	3GGP 162 430-••H	1470	91.2	91.5	90.6	0.82	21.2	7.8	71.4	3.0	3.5	0.096	226	62
15	M3GP 160 MLE	3GGP 162 450-••H	1467	92.0	92.4	92.1	0.84	28.0	7.8	97.6	3.0	3.4	0.13	249	61
18.5	M3GP 180 MLA	3GGP 182 410-••H	1474	91.6	92.0	91.2	0.83	35.1	7.2	119	2.6	3.1	0.19	271	62
22	M3GP 180 MLB	3GGP 182 420-••H	1471	91.6	92.4	92.2	0.83	41.7	6.8	142	2.5	3.0	0.21	279	62
30	M3GP 200 MLB	3GGP 202 420-••G	1475	93.6	94.0	93.7	0.85	54.4	7.4	194	3.0	2.8	0.34	305	61
37	M3GP 225 SMB	3GGP 222 220-••G	1480	93.6	93.9	93.4	0.85	67.1	7.6	238	3.2	2.9	0.42	355	67
45	M3GP 225 SMC	3GGP 222 230-••G	1477	94.1	94.6	94.4	0.88	78.4	7.6	290	3.2	2.7	0.49	390	67
55	M3GP 250 SMA	3GGP 252 210-••G	1479	94.3	94.3	93.6	0.84	100	7.2	355	2.5	3.1	0.72	415	66
75	M3GP 280 SMA	3GGP 282 210-••G	1484	94.5	94.5	93.9	0.85	134	6.9	482	2.5	2.8	1.25	625	68
90	M3GP 280 SMB	3GGP 282 220-••G	1483	94.7	94.8	94.4	0.86	159	7.2	579	2.5	2.7	1.5	665	68
110	M3GP 315 SMA	3GGP 312 210-••G	1487	95.1	95.1	94.3	0.86	194	7.2	706	2.0	2.5	2.3	900	70
132	M3GP 315 SMB	3GGP 312 220-••G	1487	95.4	95.4	94.7	0.86	232	7.1	847	2.3	2.7	2.6	960	70
160	M3GP 315 SMC	3GGP 312 230-••G	1487	95.6	95.6	95.1	0.85	284	7.2	1027	2.4	2.9	2.9	1000	70
200	M3GP 315 MLA	3GGP 312 410-••G	1486	95.6	95.6	95.3	0.86	351	7.2	1285	2.5	2.9	3.5	1160	70
250	M3GP 355 SMA	3GGP 352 210-••G	1488	95.9	95.9	95.5	0.86	437	7.1	1604	2.3	2.7	5.9	1610	74
315	M3GP 355 SMB	3GGP 352 220-••G	1488	95.9	95.9	95.6	0.86	551	7.3	2021	2.3	2.8	6.9	1780	74
355	M3GP 355 SMC	3GGP 352 230-••G	1487	95.9	95.9	95.7	0.86	621	6.8	2279	2.4	2.7	7.2	1820	78
400	M3GP 355 MLA	3GGP 352 410-••G	1489	96.3	96.3	95.9	0.85	705	6.8	2565	2.3	2.6	8.4	2140	78
450	M3GP 355 MLB	3GGP 352 420-••G	1490	96.8	96.8	96.3	0.86	780	6.9	2884	2.3	2.9	8.4	2140	78
500	M3GP 355 LKA	3GGP 352 810-••G	1490	97.0	97.0	96.5	0.86	865	6.8	3204	2.0	3.0	10.0	2500	78
560	M3GP 400 LA	3GGP 402 510-••G	1491	96.8	96.8	96.3	0.85	982	7.4	3586	2.4	2.8	15.0	3200	78
560	M3GP 400 LKA	3GGP 402 810-••G	1491	96.8	96.8	96.3	0.85	982	7.4	3586	2.4	2.8	15.0	3200	78
630	M3GP 400 LB	3GGP 402 520-••G	1491	97.0	97.0	96.5	0.87	1077	7.6	4034	2.2	2.9	16.0	3300	78
630	M3GP 400 LKB	3GGP 402 820-••G	1491	97.0	97.0	96.5	0.87	1077	7.6	4034	2.2	2.9	16.0	3300	78
710	¹⁾ M3GP 400 LC	3GGP 402 530-••G	1491	97.1	97.1	96.6	0.86	1227	7.6	4547	2.4	3.0	17.0	3400	78
710	¹⁾ M3GP 400 LKC	3GGP 402 830-••G	1491	97.1	97.1	96.6	0.86	1227	7.6	4547	2.4	3.0	17.0	3400	78
1500 r/min = 4-poles			400 V 50 Hz			High-output design									
18.5	M3GP 160 MLF	3GGP 162 460-••H	1469	91.7	92.1	91.4	0.83	35.0	7.8	120	3.2	3.5	0.13	249	68
22	²⁾ M3GP 160 MLG	3GGP 162 470-••H	1466	90.8	91.1	90.4	0.81	43.1	7.9	143	3.3	3.6	0.13	249	68
30	¹⁾²⁾ M3GP 180 MLC	3GGP 182 430-••H	1473	92.2	92.3	91.6	0.81	57.9	7.1	194	2.8	3.2	0.248	298	66
37	M3GP 200 MLC	3GGP 202 430-••G	1475	93.0	93.1	92.3	0.82	70.0	7.5	239	3.5	3.2	0.34	305	73
55	M3GP 225 SMD	3GGP 222 240-••G	1483	94.3	94.5	93.9	0.83	101	7.4	354	3.4	2.9	0.55	410	68
60	²⁾³⁾ M3GP 225 SME	3GGP 222 250-••G	1479	93.6	93.7	92.9	0.84	110	8.0	387	3.6	3.0	0.55	410	74
75	³⁾ M3GP 250 SMB	3GGP 252 220-••G	1476	94.3	94.5	94.2	0.86	133	7.6	485	2.8	3.2	0.88	470	73
110	M3GP 280 SMC	3GGP 282 230-••G	1485	95.1	95.2	94.7	0.86	194	7.6	707	3.0	3.0	1.85	725	68

¹⁾ Temperature rise class F

²⁾ Efficiency class IE1

³⁾ For 400-415 V 50 Hz (380 V 50 Hz voltage code B)

⁴⁾ Missing data on request

The two bullets in the product code indicate choice of mounting arrangements, voltage and frequency code (see ordering information page).

I_s / I_N = Starting current
T_I / T_N = Locked rotor torque
T_b / T_N = Pull-out torque

Efficiency values are given according to IEC 60034-2-1; 2007. Please note that the values are not comparable without knowing the testing method. ABB has calculated the efficiency values according to indirect method, stray load losses (additional losses) determined from measuring.

Dust ignition proof cast iron motors

Technical data for Category 3 D - T = 125°C - IP 55

IE2

IP 55 - IC 411 - Insulation class F, temperature rise class B
IE2 efficiency class according to IEC 60034-30; 2008



Output kW	Motor type	Product code	Speed r/min	Efficiency IEC 60034-2-1; 2007			Power factor cos φ	Current			Torque			Moment of inertia J = 1/4 GD ² kgm ²	Weight kg	Sound pressure level L _{PA} dB
				Full load 100%	3/4 load 75%	1/2 load 50%		I _N A	I _s I _N	T _N Nm	T _l T _N	T _b T _N				
1000 r/min = 6-poles 400 V 50 Hz			CENELEC-design													
0.37	M3GP 80 MA	3GGP 083 310-••	3)													
0.55	M3GP 80 MB	3GGP 083 320-••	3)													
0.75	M3GP 90 SLA	3GGP 093 010-••	3)													
1.1	M3GP 90 SLC	3GGP 093 030-••	3)													
1.5	M3GP 100 LA	3GGP 103 510-••	3)													
2.2	M3GP 112 MB	3GGP 113 320-••	3)													
3	M3GP 132 SMB	3GGP 133 220-••	3)													
4	M3GP 132 SMC	3GGP 133 230-••	3)													
5.5	M3GP 132 SMD	3GGP 133 240-••	3)													
7.5	M3GP 160 MLA	3GGP 163 410-••H	965	87.2	88.4	88.2	0.81	15.3	6.5	74.2	1.9	3.0	0.088	220	57	
11	M3GP 160 MLB	3GGP 163 420-••H	972	90.1	90.8	90.4	0.81	21.7	7.8	108	2.3	3.5	0.126	247	65	
15	M3GP 180 MLB	3GGP 183 420-••H	972	90.4	91.0	90.4	0.82	29.2	7.2	147	1.9	3.2	0.25	298	58	
18.5	M3GP 200 MLA	3GGP 203 410-••G	983	90.9	91.1	90.2	0.82	35.8	7.1	179	3.2	3.1	0.37	265	66	
22	M3GP 200 MLB	3GGP 203 420-••G	983	91.6	91.9	91.0	0.82	42.2	7.5	213	3.2	3.2	0.43	285	61	
30	M3GP 225 SMB	3GGP 223 220-••G	985	92.2	92.6	92.2	0.82	57.2	7.4	290	3.4	3.0	0.64	350	61	
37	M3GP 250 SMA	3GGP 253 210-••G	987	93.1	93.4	92.8	0.81	70.8	7.2	357	3.2	2.9	1.16	420	66	
45	M3GP 280 SMA	3GGP 283 210-••G	990	93.4	93.6	93.1	0.84	82.7	7.0	434	2.5	2.5	1.85	605	66	
55	M3GP 280 SMB	3GGP 283 220-••G	990	93.8	94.0	93.3	0.84	100	7.0	530	2.7	2.6	2.2	645	66	
75	M3GP 315 SMA	3GGP 313 210-••G	992	94.4	94.4	93.5	0.82	139	7.4	721	2.4	2.8	3.2	830	70	
90	M3GP 315 SMB	3GGP 313 220-••G	992	94.8	94.8	94.2	0.84	163	7.5	866	2.4	2.8	4.1	930	70	
110	M3GP 315 SMC	3GGP 313 230-••G	991	95.0	95.0	94.6	0.83	201	7.4	1059	2.5	2.9	4.9	1000	70	
132	M3GP 315 MLA	3GGP 313 410-••G	991	95.3	95.4	94.9	0.83	240	7.5	1271	2.7	3.0	5.8	1150	68	
160	M3GP 355 SMA	3GGP 353 210-••G	993	95.4	95.4	94.8	0.83	291	7.0	1538	2.0	2.6	7.9	1520	75	
200	M3GP 355 SMB	3GGP 353 220-••G	993	95.7	95.7	95.1	0.84	359	7.2	1923	2.2	2.7	9.7	1680	75	
250	M3GP 355 SMC	3GGP 353 230-••G	993	95.7	95.7	95.1	0.83	454	7.4	2404	2.6	2.9	11.3	1820	75	
315	M3GP 355 MLB	3GGP 353 420-••G	992	95.7	95.7	95.2	0.83	572	7.0	3032	2.5	2.7	13.5	2180	75	
355	M3GP 355 LKA	3GGP 353 810-••G	992	95.7	95.7	95.1	0.83	645	7.6	3417	2.7	2.9	15.5	2500	75	
400	M3GP 400 LA	3GGP 403 510-••G	993	96.2	96.3	95.8	0.82	731	7.1	3846	2.3	2.7	17.0	2900	76	
400	M3GP 400 LKA	3GGP 403 810-••G	993	96.2	96.3	95.8	0.82	731	7.1	3846	2.3	2.7	17.0	2900	76	
450	M3GP 400 LB	3GGP 403 520-••G	994	96.6	96.6	96.1	0.82	819	7.4	4323	2.4	2.8	20.5	3150	76	
450	M3GP 400 LKB	3GGP 403 820-••G	994	96.6	96.6	96.1	0.82	819	7.4	4323	2.4	2.8	20.5	3150	76	
500	M3GP 400 LC	3GGP 403 530-••G	993	96.6	96.7	96.2	0.83	900	7.2	4808	2.5	2.7	22.0	3300	76	
500	M3GP 400 LKC	3GGP 403 830-••G	993	96.6	96.7	96.2	0.83	900	7.2	4808	2.5	2.7	22.0	3300	76	
560	M3GP 400 LD	3GGP 403 540-••G	993	96.9	96.9	96.4	0.85	981	7.4	5385	2.4	2.8	24.0	3400	77	
560	M3GP 400 LKD	3GGP 403 840-••G	993	96.9	96.9	96.4	0.85	981	7.4	5385	2.4	2.8	24.0	3400	77	
1000 r/min = 6-poles 400 V 50 Hz			High-output design													
14	^{1) 2)} M3GP 160 MLC	3GGP 163 430-••H	969	89.2	89.4	88.0	0.75	30.2	7.9	137	2.8	3.9	0.126	247	64	
18.5	²⁾ M3GP 180 MLC	3GGP 183 430-••H	975	90.1	90.2	88.7	0.74	40.0	7.2	181	2.0	3.2	0.25	298	61	
30	²⁾ M3GP 200 MLC	3GGP 203 430-••G	983	91.6	91.7	90.5	0.80	59.0	7.5	291	3.5	3.4	0.49	305	65	
37	²⁾ M3GP 225 SMC	3GGP 223 230-••G	983	92.1	92.5	92.1	0.83	69.8	7.1	359	3.0	2.8	0.75	380	64	
45	M3GP 250 SMB	3GGP 253 220-••G	986	93.1	93.3	92.6	0.82	85.0	7.2	435	3.3	2.8	1.49	465	65	
75	M3GP 280 SMC	3GGP 283 230-••G	990	94.2	94.5	94.1	0.84	136	7.3	723	2.8	2.7	2.85	725	66	

- ¹⁾ Temperature rise class F
- ²⁾ Efficiency class IE1
- ³⁾ Missing data on request

The two bullets in the product code indicate choice of mounting arrangements, voltage and frequency code (see ordering information page).

I_s / I_N = Starting current
T_l / T_N = Locked rotor torque
T_b / T_N = Pull-out torque

Efficiency values are given according to IEC 60034-2-1; 2007. Please note that the values are not comparable without knowing the testing method. ABB has calculated the efficiency values according to indirect method, stray load losses (additional losses) determined from measuring.

Dust ignition proof cast iron motors

Technical data for Category 3 D - T = 125°C - IP 55



IP 55 - IC 411 - Insulation class F, temperature rise class B

Output kW	Motor type	Product code	Speed r/min	Efficiency IEC 60034-2-1; 2007			Power factor cos φ	Current					Moment of inertia J = 1/4 GD ² kgm ²	Weight kg	Sound pressure level L _{PA} dB	
				Full load 100%	3/4 load 75%	1/2 load 50%		I _N A	I _s A	T _N Nm	T _I Nm	T _b Nm				
750 r/min = 8-poles 400 V 50 Hz			CENELEC-design													
0.18	M3GP 80 MA	3GGP 084 310-••	1)													
0.25	M3GP 80 MB	3GGP 084 320-••	1)													
0.37	M3GP 90 SLA	3GGP 094 010-••	1)													
0.55	M3GP 90 SLC	3GGP 094 030-••	1)													
0.75	M3GP 100 LA	3GGP 104 510-••	1)													
1.1	M3GP 100 LB	3GGP 104 520-••	1)													
1.5	M3GP 112 MC	3GGP 114 330-••	1)													
2.2	M3GP 132 SMC	3GGP 134 230-••	1)													
3	M3GP 132 SMD	3GGP 134 240-••	1)													
4	M3GP 160 MLA	3GGP 164 410-••H	722	86.7	87.4	86.6	0.71	9.3	5.4	52.9	1.7	2.8	0.133	245	59	
5.5	M3GP 160 MLB	3GGP 164 420-••H	723	86.8	87.6	86.8	0.71	12.8	5.8	72.6	1.9	3.1	0.133	245	53	
7.5	M3GP 160 MLC	3GGP 164 430-••H	718	85.5	86.3	85.5	0.70	18.0	5.7	99.7	2.1	3.1	0.133	245	55	
11	M3GP 180 MLB	3GGP 184 420-••H	723	88.3	89.2	88.7	0.72	24.9	5.7	145	1.7	2.7	0.245	292	63	
15	M3GP 200 MLA	3GGP 204 410-••G	734	89.9	90.3	89.6	0.79	30.4	7.0	195	2.4	3.2	0.45	280	56	
18.5	M3GP 225 SMA	3GGP 224 210-••G	734	90.0	90.3	89.3	0.74	40.0	6.1	240	2.2	3.0	0.61	335	55	
22	M3GP 225 SMB	3GGP 224 220-••G	732	90.6	91.2	90.6	0.77	45.5	6.5	287	2.2	2.9	0.68	350	56	
30	M3GP 250 SMA	3GGP 254 210-••G	735	91.4	91.2	90.7	0.78	60.7	6.7	389	2.0	2.9	1.25	420	56	
37	M3GP 280 SMA	3GGP 284 210-••G	741	92.7	92.7	91.6	0.78	73.8	7.3	476	1.7	3.0	1.85	605	65	
45	M3GP 280 SMB	3GGP 284 220-••G	741	93.2	93.2	92.2	0.78	89.3	7.6	579	1.8	3.1	2.2	645	65	
55	M3GP 315 SMA	3GGP 314 210-••G	742	93.4	93.5	92.7	0.81	104	7.1	707	1.6	2.7	3.2	830	62	
75	M3GP 315 SMB	3GGP 314 220-••G	741	93.7	93.9	93.4	0.82	140	7.1	966	1.7	2.7	4.1	930	62	
90	M3GP 315 SMC	3GGP 314 230-••G	741	94.0	94.2	93.6	0.82	168	7.4	1159	1.8	2.7	4.9	1000	64	
110	M3GP 315 MLA	3GGP 314 410-••G	740	94.0	94.3	94.0	0.83	203	7.3	1419	1.8	2.7	5.8	1150	72	
132	M3GP 355 SMA	3GGP 354 210-••G	744	94.7	94.7	94.0	0.80	251	7.5	1694	1.5	2.6	7.9	1520	69	
160	M3GP 355 SMB	3GGP 354 220-••G	744	95.2	95.2	94.5	0.80	303	7.6	2053	1.6	2.6	9.7	1680	69	
200	M3GP 355 SMC	3GGP 354 230-••G	743	95.3	95.4	94.8	0.80	378	7.4	2570	1.6	2.6	11.3	1820	69	
250	M3GP 355 MLB	3GGP 354 420-••G	743	95.4	95.5	95.0	0.80	472	7.5	3213	1.6	2.7	13.5	2180	72	
315	M3GP 400 LA	3GGP 404 510-••G	744	96.1	96.2	95.8	0.81	584	7.0	4043	1.2	2.6	17.0	2900	71	
315	M3GP 400 LKA	3GGP 404 810-••G	744	96.1	96.2	95.8	0.81	584	7.0	4043	1.2	2.6	17.0	2900	71	
355	M3GP 400 LB	3GGP 404 520-••G	743	96.2	96.3	96.1	0.83	641	6.8	4562	1.2	2.5	21.0	3200	71	
355	M3GP 400 LKB	3GGP 404 820-••G	743	96.2	96.3	96.1	0.83	641	6.8	4562	1.2	2.5	21.0	3200	71	
400	M3GP 400 LC	3GGP 404 530-••G	744	96.3	96.4	96.0	0.82	731	7.4	5134	1.3	2.7	24.0	3400	71	
400	M3GP 400 LKC	3GGP 404 830-••G	744	96.3	96.4	96.0	0.82	731	7.4	5134	1.3	2.7	24.0	3400	71	
750 r/min = 8-poles 400 V 50 Hz			High-output design													
18.5	M3GP 200 MLB	3GGP 204 420-••G	734	89.8	90.2	89.6	0.80	37.1	6.9	240	2.2	3.2	0.54	300	57	
30	M3GP 225 SMC	3GGP 224 230-••G	731	90.7	91.5	91.3	0.78	61.2	6.3	391	2.3	3.0	0.75	375	59	
37	M3GP 250 SMB	3GGP 254 220-••G	737	92.2	91.7	91.0	0.78	74.2	7.5	479	2.3	3.4	1.52	465	59	
55	M3GP 280 SMC	3GGP 284 230-••G	741	93.4	93.5	92.8	0.80	106	7.9	708	1.9	3.1	2.85	725	65	

1) Missing data on request

The two bullets in the product code indicate choice of mounting arrangements, voltage and frequency code (see ordering information page).

I_s / I_N = Starting current
T_I / T_N = Locked rotor torque
T_b / T_N = Pull-out torque

Efficiency values are given according to IEC 60034-2-1; 2007. Please note that the values are not comparable without knowing the testing method. ABB has calculated the efficiency values according to indirect method, stray load losses (additional losses) determined from measuring.

Dust ignition proof premium efficiency cast iron motors

Technical data for Category 3 D - T = 125°C - IP 55

IE3



IP 55 - IC 411 - Insulation class F, temperature rise class B
IE3 efficiency class according to IEC 60034-30; 2008

Output kW	Motor type	Product code	Speed r/min	Efficiency IEC 60034-2-1; 2007			Power factor cos φ	Current		Torque			Moment of inertia J = 1/4 GD ² kgm ²	Weight kg	Sound pressure level L _{PA} dB
				Full load 100%	3/4 load 75%	1/2 load 50%		I _N A	I _s I _N	T _N Nm	T _l T _N	T _b T _N			
3000 r/min = 2-poles 400 V 50 Hz			GENELEC-design												
30	M4GP 200 MLE	3GGP 201 450-••J	2957	94.1	94.3	93.7	0.87	52.8	7.7	96.8	2.9	3.3	0.22	310	75
37	M4GP 200 MLF	3GGP 201 460-••J	2958	94.6	94.8	94.3	0.86	65.6	8.3	119	3.2	3.5	0.22	310	75
45	M4GP 225 SME	3GGP 221 250-••J	2970	95.2	95.2	94.6	0.88	77.5	8.0	144	3.0	3.4	0.34	406	76
55	M4GP 250 SMD	3GGP 251 240-••J	2977	95.5	95.7	95.2	0.91	91.3	8.1	176	2.6	2.7	0.68	493	75
75	M4GP 280 SMB	3GGP 281 220-••K	2979	95.5	95.4	94.6	0.87	130	7.3	240	2.1	2.9	0.9	665	77
90	M4GP 280 SMC	3GGP 281 230-••K	2981	95.7	95.6	94.8	0.88	154	8.0	288	2.5	3.1	1.15	725	77
110	M4GP 315 SMB	3GGP 311 220-••K	2982	95.9	95.7	95.0	0.87	190	6.7	352	1.9	2.6	1.4	940	77
132	M4GP 315 SMC	3GGP 311 230-••K	2984	95.9	95.9	95.3	0.88	225	7.9	422	2.4	3.0	1.7	1025	77
160	M4GP 315 MLA	3GGP 311 410-••K	2982	96.1	96.1	95.8	0.90	267	7.3	512	2.2	2.7	2.1	1190	77
200	M4GP 315 MLB	3GGP 311 420-••K	2982	96.2	96.2	96.0	0.90	333	6.8	640	1.9	2.6	2.2	1220	77
200 ¹⁾	M4GP 355 SMA	3GGP 351 210-••K	2984	96.2	96.1	95.5	0.89	337	7.6	640	2.0	3.1	3.0	1600	83
250	M4GP 315 LKB	3GGP 311 820-••K	2981	96.3	96.3	96.2	0.91	411	7.9	800	2.5	2.7	2.9	1540	77
250 ¹⁾	M4GP 355 SMB	3GGP 351 220-••K	2983	96.3	96.3	95.9	0.90	416	7.6	800	2.2	3.0	3.4	1680	83
315 ¹⁾	M4GP 355 SMC	3GGP 351 230-••K	2984	96.4	96.4	95.9	0.89	529	7.8	1008	2.3	2.8	3.6	1750	83
355 ¹⁾	M4GP 355 MLA	3GGP 351 410-••K	2982	96.5	96.5	96.3	0.90	589	7.5	1136	2.3	2.6	4.1	2000	83

¹⁾ 3dB(A) sound pressure level reduction with unidirectional fan construction. Direction of rotation must be stated when ordering, see variant codes 044 and 045

The two bullets in the product code indicate choice of mounting arrangements, voltage and frequency code (see ordering information page).

I_s / I_N = Starting current
T_l / T_N = Locked rotor torque
T_b / T_N = Pull-out torque

Efficiency values are given according to IEC 60034-2-1; 2007. Please note that the values are not comparable without knowing the testing method. ABB has calculated the efficiency values according to indirect method, stray load losses (additional losses) determined from measuring.

Dust ignition proof premium efficiency cast iron motors

Technical data for Category 3 D - T = 125°C - IP 55

IE3

IP 55 - IC 411 - Insulation class F, temperature rise class B
IE3 efficiency class according to IEC 60034-30; 2008



Output		Product code		Efficiency IEC 60034-2-1; 2007			Current		Torque			Moment of inertia J = 1/4 GD ² kgm ²	Weight kg	Sound pressure level L _{PA} dB	
				Full load 100%	3/4 load 75%	1/2 load 50%	Power factor cos φ	I _N A	I _s / I _N	T _N Nm	T _l / T _N				T _b / T _N
kW	Motor type			Speed r/min											
1500 r/min = 4-poles		400 V 50 Hz		GENELEC-design											
30	M4GP 200 MLE	3GGP 202 450-••J	1478	94.2	94.6	94.5	0.86	53.4	7.8	193	3.2	2.9	0.37	316	61
37	M4GP 225 SME	3GGP 222 250-••J	1482	94.6	95.0	94.8	0.88	64.1	7.6	238	2.9	3.3	0.55	410	67
45	M4GP 225 SMF	3GGP 222 260-••J	1479	94.8	95.2	95.0	0.87	78.7	8.0	290	3.2	3.4	0.59	416	67
55	M4GP 250 SMC	3GGP 252 230-••J	1483	95.3	95.4	95.0	0.86	96.8	7.3	354	2.7	3.4	0.98	495	66
75	M4GP 280 SMB	3GGP 282 220-••K	1486	95.7	95.8	95.3	0.85	133	7.4	481	2.5	2.8	1.5	665	66
90	M4GP 280 SMC	3GGP 282 230-••K	1487	95.9	96.0	95.5	0.85	159	7.9	577	2.9	3.0	1.85	725	66
110	M4GP 315 SMC	3GGP 312 230-••K	1490	96.3	96.3	95.7	0.85	193	7.8	704	2.4	3.1	2.9	1000	68
132	M4GP 315 SMD	3GGP 312 240-••K	1490	96.4	96.4	95.9	0.85	232	7.9	845	2.6	3.2	3.2	1065	68
160	M4GP 315 MLB	3GGP 312 420-••K	1489	96.4	96.4	96.1	0.86	278	7.9	1026	2.7	3.0	3.9	1220	68
200	M4GP 315 LKB	3GGP 312 820-••K	1490	96.5	96.5	96.3	0.87	343	7.6	1281	2.5	2.9	5.0	1520	74
200	M4GP 355 SMA	3GGP 352 210-••K	1490	96.5	96.5	96.3	0.87	343	7.3	1281	2.1	2.7	5.9	1610	74
250	M4GP 315 LKC	3GGP 312 830-••K	1491	96.6	96.6	96.4	0.87	429	7.8	1601	2.3	3.0	5.5	1600	74
250	M4GP 355 SMB	3GGP 352 220-••K	1491	96.6	96.6	96.3	0.87	429	7.8	1601	2.5	2.9	6.9	1780	74
315	M4GP 355 SMC	3GGP 352 230-••K	1491	96.7	96.7	96.3	0.85	553	7.4	2017	2.8	2.9	7.2	1820	74
355	M4GP 355 MLA	3GGP 352 410-••K	1491	96.7	96.7	96.4	0.86	616	7.9	2273	2.7	2.9	8.4	2140	74

The two bullets in the product code indicate choice of mounting arrangements, voltage and frequency code (see ordering information page).

I_s / I_N = Starting current
T_l / T_N = Locked rotor torque
T_b / T_N = Pull-out torque

Efficiency values are given according to IEC 60034-2-1; 2007. Please note that the values are not comparable without knowing the testing method. ABB has calculated the efficiency values according to indirect method, stray load losses (additional losses) determined from measuring.

Dust ignition proof premium efficiency cast iron motors

Technical data for Category 3 D - T = 125°C - IP 55

IE3



IP 55 - IC 411 - Insulation class F, temperature rise class B
IE3 efficiency class according to IEC 60034-30; 2008

Output kW	Motor type	Product code	Speed r/min	Efficiency IEC 60034-2-1; 2007			Power factor cos φ	Current		Torque			Moment of inertia J = 1/4 GD ² kgm ²	Weight kg	Sound pressure level L _{PA} dB
				Full load 100%	3/4 load 75%	1/2 load 50%		I _N A	I _s I _N	T _N Nm	T _l T _N	T _b T _N			
1000 r/min = 6-poles 400 V 50 Hz			CENELEC-design												
18.5	M4GP 200 MLC	3GGP 203 430-••J	987	92.5	92.8	92.4	0.84	34.3	8.1	178	3.2	3.4	0.49	305	61
22	M4GP 200 MLD	3GGP 203 440-••J	986	92.9	93.3	92.9	0.84	40.6	8.2	213	3.3	3.4	0.54	314	61
30	M4GP 225 SME	3GGP 223 250-••J	989	94.0	94.2	93.8	0.85	54.1	7.9	289	2.5	3.2	0.92	410	61
37	M4GP 250 SMD	3GGP 253 240-••J	990	94.4	94.8	94.6	0.84	67.3	8.2	356	3.3	3.3	1.74	500	65
45	M4GP 280 SMB	3GGP 283 220-••K	991	94.8	94.9	94.2	0.86	79.6	6.9	433	2.4	2.6	2.2	680	65
55	M4GP 280 SMC	3GGP 283 230-••K	990	95.1	95.1	94.7	0.86	97	6.8	530	2.4	2.6	2.85	725	65
75	M4GP 315 SMC	3GGP 313 230-••K	993	95.3	95.3	94.8	0.84	135	7.0	721	2.2	2.8	4.9	1000	67
90	M4GP 315 SMD	3GGP 313 240-••K	994	95.5	95.5	94.9	0.83	163	7.2	864	2.4	2.9	4.9	1040	67
110	M4GP 315 MLB	3GGP 313 420-••K	993	95.5	95.5	95.1	0.84	197	6.9	1057	2.3	2.7	6.3	1200	68
132	M4GP 315 LKA	3GGP 313 810-••K	993	95.7	95.7	95.4	0.83	239	6.9	1269	2.4	2.7	7.3	1410	68
160	M4GP 315 LKC	3GGP 313 830-••K	994	95.9	95.9	95.5	0.83	290	7.4	1537	2.7	2.9	9.2	1600	68
160	M4GP 355 SMB	3GGP 353 220-••K	995	95.9	95.9	95.5	0.83	290	7.0	1535	2.1	2.7	9.7	1680	73
200	M4GP 355 SMC	3GGP 353 230-••K	995	96.0	96.0	95.7	0.83	362	7.3	1919	2.3	2.8	11.3	1820	73
250	M4GP 355 MLB	3GGP 353 420-••K	995	96.0	96.0	95.8	0.83	452	7.1	2399	2.3	2.7	13.5	2180	73
315	M4GP 355 LKA	3GGP 353 810-••K	994	96.0	96.0	95.8	0.83	570	6.9	3026	2.3	2.6	15.5	2500	76
355	M4GP 355 LKB	3GGP 353 820-••K	995	96.0	96.0	95.6	0.80	667	7.7	3407	2.7	2.9	16.5	2600	76

The two bullets in the product code indicate choice of mounting arrangements, voltage and frequency code (see ordering information page).

I_s / I_N = Starting current
T_l / T_N = Locked rotor torque
T_b / T_N = Pull-out torque

Efficiency values are given according to IEC 60034-2-1; 2007. Please note that the values are not comparable without knowing the testing method. ABB has calculated the efficiency values according to indirect method, stray load losses (additional losses) determined from measuring.

Dust ignition proof aluminum motors

IE2

Technical data for Category 3 D - T = 125°C - IP 55



IP 55 - IC 411 - Insulation class F, temperature rise class B
IE2 efficiency class according to IEC 60034-30; 2008

Output kW	Motor type	Product code	Speed r/min	Efficiency IEC 60034-2-1; 2007			Power factor cos φ	Current					Moment of inertia J = 1/4 GD ² kgm ²	Weight kg	Sound pressure level L _{PA} dB
				Full load 100%	3/4 load 75%	1/2 load 50%		I _N A	I _s / I _N	T _N Nm	T _I / T _N	T _b / T _N			
3000 r/min = 2-poles 400 V 50 Hz			GENELEC-design												
0.18	M3AAD 63 A	3GAA 061 311-••C	2820	75.0	72.0	66.1	0.62	0.55	4.2	0.6	3.5	3.1	0.00013	3.9	54
0.25	M3AAD 63 B	3GAA 061 312-••C	2810	78.6	77.0	69.6	0.69	0.66	4.5	0.84	3.6	3.3	0.00016	4.4	54
0.37	M3AAD 71 A	3GAA 071 311-••E	2800	71.6	72.3	70.2	0.76	0.98	5.1	1.26	3.0	2.9	0.00035	4.9	58
0.55	M3AAD 71 B	3GAA 071 312-••E	2790	78.4	79.8	78.7	0.78	1.29	5.3	1.88	2.9	2.8	0.00045	5.9	58
0.75	M3AAD 80 B	3GAA 081 312-••E	2845	80.1	79.7	76.6	0.73	1.85	7.5	2.5	3.7	3.9	0.0009	10.5	60
1.1	M3AAD 80 C	3GAA 081 313-••E	2880	82.1	82.0	79.2	0.81	2.3	7.6	3.6	2.8	3.6	0.0012	11	60
1.5	M3AAD 90 L	3GAA 091 312-••E	2900	84.1	85.0	83.5	0.86	2.9	7.6	4.9	2.5	3.3	0.0024	16	60
2.2	M3AAD 90 LB	3GAA 091 313-••E	2875	84.6	85.7	85.5	0.85	4.4	6.9	7.3	2.8	3.2	0.0027	18	63
3	M3AAD 100 LB	3GAA 101 312-••E	2930	87.9	87.9	86.6	0.86	5.7	8.7	9.7	3.3	4.0	0.005	25	62
4	M3AAD 112 MB	3GAA 111 312-••E	2885	86.1	87.0	88.0	0.88	7.6	7.6	13.2	2.5	2.8	0.0062	30	68
5.5	M3AAD 132 SB	3GAA 131 312-••E	2915	88.0	88.5	87.6	0.82	11.0	7.9	18.0	2.6	3.6	0.016	42	73
7.5	M3AAD 132 SC	3GAA 131 313-••E	2915	88.5	88.7	88.1	0.87	14.0	7.6	24.5	2.2	3.2	0.022	56	73
11	M3AA 160 MLA	3GAA 161 031-••G	2938	90.7	91.5	91.1	0.91	19.2	7.5	35.7	2.4	3.1	0.044	91	69
15	M3AA 160 MLB	3GAA 161 036-••G	2934	91.5	92.5	92.2	0.91	26.0	7.5	48.8	2.5	3.3	0.053	105	69
18.5	M3AA 160 MLC	3GAA 161 037-••G	2932	92.0	93.1	93.1	0.92	31.5	7.5	60.2	2.9	3.4	0.063	123	69
22	M3AA 180 MLA	3GAA 181 031-••G	2952	92.2	92.7	92.2	0.87	39.5	7.7	71.1	2.8	3.3	0.076	132	69
30	M3AA 200 MLA	3GAA 201 035-••G	2956	93.1	93.5	92.9	0.90	51.6	7.7	96.9	2.7	3.1	0.178	210	72
37	M3AA 200 MLB	3GAA 201 036-••G	2959	93.4	93.7	93.0	0.90	63.5	8.2	119	3.0	3.3	0.196	225	72
45	M3AA 225 SMA	3GAA 221 031-••G	2961	93.6	93.9	93.1	0.88	78.8	6.7	145	2.5	2.5	0.244	263	74
55	M3AA 250 SMA	3GAA 251 031-••G	2967	94.1	94.4	93.8	0.88	95.8	6.8	177	2.2	2.7	0.507	304	75
75	M3AA 280 SMA	3GAA 281 031-••G	2968	94.5	94.8	94.3	0.89	128	7.1	241	2.5	2.8	0.583	389	75
90	¹⁾ M3AA 280 SMB	3GAA 281 032-••G	2971	95.0	95.2	94.8	0.89	153	7.8	289	2.6	3.2	0.644	425	75
3000 r/min = 2-poles 400 V 50 Hz			High-output design												
0.75	²⁾ M3AAD 71 C	3GAA 071 003-••E	2785	76.6	77.1	76.4	0.80	1.76	5.3	2.5	3.2	3.2	0.00056	6.5	58
1.5	¹⁾²⁾ M3AAD 80 C	3GAA 081 003-••E	2830	80.7	82.0	80.0	0.83	3.2	5.8	5.0	2.6	3.0	0.0011	11	60
2.7	¹⁾²⁾ M3AAD 90 LB	3GAA 091 003-••E	2860	81.0	81.2	79.0	0.86	5.5	7.0	9.0	2.6	3.0	0.0027	18	68
4	¹⁾²⁾ M3AAD 100 LB	3GAA 101 002-••E	2900	84.3	83.9	83.7	0.86	7.9	7.5	13.1	2.7	3.6	0.005	25	68
5.5	¹⁾²⁾ M3AAD 112 MB	3GAA 111 102-••E	2850	86.4	87.0	87.4	0.90	10.2	7.2	18.4	3.4	3.4	0.0062	30	68
9.2	¹⁾²⁾ M3AAD 132 SBB	3GAA 131 004-••E	2875	87.0	88.0	86.5	0.92	16.5	7.2	30.5	2.5	3.0	0.018	52	68
11	M3AAD 132 SMB	3GAA 131 315-••E	2900	90.3	90.8	90.4	0.87	20.2	8.5	36.2	2.7	3.7	0.01865	77	68
11	¹⁾²⁾ M3AAD 132 SC	3GAA 131 003-••E	2890	88.7	89.5	89.3	0.89	20.1	8.1	36.3	2.8	3.4	0.018	52	68
15	M3AAD 132 SMC	3GAA 131 316-••E	2905	90.4	90.7	89.8	0.84	28.5	9.1	49.3	3.3	4.0	0.02	81	69
18.5	M3AAD 132 SME	3GAA 131 317-••E	2895	91.1	92.2	92.4	0.89	32.9	9.7	61.0	3.2	4.3	0.02559	93	68
22	¹⁾²⁾ M3AAD 132 SME	3GAA 131 008-••E	2890	90.2	91.0	90.9	0.85	41.4	9.7	72.6	3.9	3.8	0.02559	91	69
30	M3AA 180 MLB	3GAA 181 032-••G	2950	92.8	93.5	93.3	0.88	53.0	7.9	97.1	2.8	3.3	0.092	149	69
45	M3AA 200 MLC	3GAA 201 033-••G	2957	93.3	93.8	93.2	0.88	79.1	8.1	145	3.1	3.3	0.196	225	72
55	M3AA 225 SMB	3GAA 221 032-••G	2961	93.9	94.3	93.6	0.88	96.0	6.5	177	2.4	2.5	0.274	286	74
75	M3AA 250 SMB	3GAA 251 032-••G	2970	94.6	94.9	94.4	0.89	128	7.6	241	2.8	3.1	0.583	351	75

¹⁾ Temperature rise class F
²⁾ Efficiency class IE1

The two bullets in the product code indicate choice of mounting arrangements, voltage and frequency code (see ordering information page).

I_s / I_N = Starting current
 T_I / T_N = Locked rotor torque
 T_b / T_N = Pull-out torque

Efficiency values are given according to IEC 60034-2-1; 2007. Please note that the values are not comparable without knowing the testing method. ABB has calculated the efficiency values according to indirect method, stray load losses (additional losses) determined from measuring.

Dust ignition proof aluminum motors

IE2

Technical data for Category 3 D - T = 125°C - IP 55



IP 55 - IC 411 - Insulation class F, temperature rise class B
IE2 efficiency class according to IEC 60034-30; 2008

Output kW	Motor type	Product code	Speed r/min	Efficiency IEC 60034-2-1; 2007			Power factor cos φ	Current					Moment of inertia J = 1/4 GD ² kgm ²	Weight kg	Sound pressure level L _{PA} dB
				Full load 100%	3/4 load 75%	1/2 load 50%		I _N A	I _s / I _N	T _N Nm	T _l / T _N	T _b / T _N			
1500 r/min = 4-poles 400 V 50 Hz			CENELEC-design												
0.12	M3AAD 63 A	3GAA 062 311-••C	1400	65.5	60.4	51.7	0.57	0.46	3.1	0.81	2.7	2.8	0.00019	4	40
0.18	M3AAD 63 B	3GAA 062 312-••C	1380	67.3	63.9	56.7	0.62	0.62	3.1	1.24	2.5	2.6	0.00026	4.5	40
0.25	M3AAD 71 A	3GAA 072 311-••E	1365	65.1	66.0	62.7	0.76	0.72	4.0	1.74	2.0	2.1	0.00066	5.2	45
0.37	M3AAD 71 B	3GAA 072 312-••E	1355	69.7	71.9	71.1	0.79	0.96	3.8	2.6	2.0	2.2	0.0008	5.9	45
0.55	M3AAD 80 A	3GAA 082 311-••E	1375	74.1	75.9	75.0	0.78	1.37	4.5	3.8	1.9	2.2	0.0013	8.5	50
0.75	M3AAD 80 D	3GAA 082 314-••E	1415	79.9	80.4	78.6	0.75	1.8	5.8	5.0	2.6	2.8	0.0016	12	50
1.1	M3AAD 90 LB	3GAA 092 314-••E	1435	83.7	84.1	83.0	0.78	2.4	6.6	7.3	2.9	3.2	0.0043	16	50
1.5	M3AAD 90 LD	3GAA 092 315-••E	1435	84.2	84.1	81.9	0.76	3.3	7.0	9.9	3.1	3.5	0.0048	17	50
2.2	M3AAD 100 LC	3GAA 102 313-••E	1450	87.1	86.8	84.8	0.78	4.6	7.3	14.4	2.8	3.4	0.009	25	54
3	M3AAD 100 LD	3GAA 102 314-••E	1445	85.7	86.1	85.1	0.79	6.3	7.0	19.8	2.4	3.0	0.011	28	63
4	M3AAD 112 MB	3GAA 112 312-••E	1445	86.7	86.5	85.2	0.75	8.8	7.3	26.4	3.1	3.4	0.0126	34	64
5.5	M3AAD 132 M	3GAA 132 312-••E	1465	89.0	89.8	89.1	0.79	11.2	6.3	35.8	1.9	2.6	0.038	48	66
7.5	M3AAD 132 MA	3GAA 132 314-••E	1460	89.1	89.9	89.5	0.79	15.3	6.4	49.0	1.8	2.6	0.048	59	63
11	M3AA 160 MLA	3GAA 162 031-••G	1466	90.4	91.6	91.3	0.84	20.9	6.8	71.6	2.2	2.8	0.081	99	62
15	M3AA 160 MLB	3GAA 162 032-••G	1470	91.4	92.4	92.2	0.83	28.5	7.1	97.4	2.6	3.0	0.099	118	62
18.5	M3AA 180 MLA	3GAA 182 031-••G	1477	91.9	92.9	92.7	0.84	34.5	7.2	119	2.6	2.9	0.166	146	62
22	M3AA 180 MLB	3GAA 182 032-••G	1475	92.4	93.3	93.2	0.84	40.9	7.3	142	2.6	3.0	0.195	163	62
30	M3AA 200 MLA	3GAA 202 031-••G	1480	93.2	94.0	93.7	0.84	55.3	7.4	193	2.8	3.0	0.309	218	63
37	M3AA 225 SMA	3GAA 222 031-••G	1479	93.4	93.9	93.4	0.84	68.0	7.1	238	2.6	2.9	0.356	240	66
45	M3AA 225 SMB	3GAA 222 032-••G	1480	93.9	94.3	93.9	0.85	81.3	7.5	290	2.8	3.2	0.44	273	66
55	M3AA 250 SMA	3GAA 252 031-••G	1480	94.4	95.0	94.7	0.85	98.9	7.0	354	2.6	2.9	0.765	314	67
72	M3AA 280 SMA	3GAA 282 031-••G	1479	94.4	95.0	94.7	0.85	129	7.4	464	2.9	3.1	0.866	389	67
1500 r/min = 4-poles 400 V 50 Hz			High-output design												
0.55	M3AAD 71 C	3GAA 072 003-••E	1375	69.0	69.3	68.5	0.76	1.51	4.2	3.8	2.4	2.4	0.0011	6.5	45
0.95 ¹⁾²⁾	M3AAD 80 C	3GAA 082 003-••E	1395	76.0	76.9	76.3	0.80	2.2	5.2	6.5	2.5	2.6	0.0023	10.5	50
1.1 ¹⁾²⁾	M3AAD 80 C	3GAA 082 004-••E	1395	76.7	77.5	77.9	0.79	2.6	5.0	7.5	2.5	2.5	0.0023	10.5	50
1.85 ¹⁾²⁾	M3AAD 90 L	3GAA 092 003-••E	1390	79.3	78.5	78.7	0.80	4.2	4.5	12.7	2.2	2.4	0.0043	16	50
2.2 ¹⁾²⁾	M3AAD 90 LB	3GAA 092 004-••E	1390	80.0	80.9	79.5	0.83	4.7	4.5	15.1	2.2	2.4	0.0048	17	50
4 ¹⁾²⁾	M3AAD 100 LC	3GAA 102 003-••E	1420	83.2	83.3	81.7	0.82	8.4	5.5	26.8	2.5	2.8	0.009	25	60
5.5 ¹⁾²⁾	M3AAD 112 MB	3GAA 112 102-••E	1420	85.1	85.5	84.5	0.80	11.6	6.0	36.9	2.7	3.1	0.0126	34	64
9.2 ¹⁾	M3AAD 132 MBA	3GAA 132 004-••E	1455	89.8	90.5	89.5	0.84	17.6	7.5	60.3	2.1	2.8	0.048	59	59
11	M3AAD 132 SMB	3GAA 132 315-••E	1460	90.4	91.0	90.1	0.79	22.2	7.7	71.9	2.1	3.1	0.0433	83	65
15	M3AAD 132 SMD	3GAA 132 316-••E	1455	90.6	91.3	91.1	0.77	31.0	7.1	98.4	2.4	2.9	0.0517	92	67
18.5	M3AA 160 MLC	3GAA 162 033-••G	1469	91.4	92.5	92.3	0.84	34.7	7.6	120	3.0	3.2	0.11	127	62
18.5 ¹⁾²⁾	M3AAD 132 SMD	3GAA 132 007-••E	1445	89.4	90.0	89.5	0.78	38.2	6.7	122	2.3	2.6	0.05166	92	69
22	M3AA 160 MLD	3GAA 162 034-••G	1463	91.6	93.0	93.2	0.85	40.7	6.9	143	2.5	2.9	0.125	140	62
37	M3AA 200 MLB	3GAA 202 032-••G	1479	93.4	94.4	94.4	0.85	67.2	7.1	238	2.6	2.9	0.343	234	63
55	M3AA 225 SMC	3GAA 222 033-••G	1478	94.0	94.7	94.5	0.85	99.3	7.4	355	2.9	3.1	0.474	287	66
68	M3AA 250 SMB	3GAA 252 032-••G	1481	94.7	95.0	94.8	0.84	123	7.9	438	3.1	3.5	0.866	350	67

¹⁾ Temperature rise class F

²⁾ Efficiency class IE1

The two bullets in the product code indicate choice of mounting arrangements, voltage and frequency code (see ordering information page).

I_s / I_N = Starting current
T_l / T_N = Locked rotor torque
T_b / T_N = Pull-out torque

Efficiency values are given according to IEC 60034-2-1; 2007. Please note that the values are not comparable without knowing the testing method. ABB has calculated the efficiency values according to indirect method, stray load losses (additional losses) determined from measuring.

Dust ignition proof aluminum motors

IE2

Technical data for Category 3 D - T = 125°C - IP 55



IP 55 - IC 411 - Insulation class F, temperature rise class B
IE2 efficiency class according to IEC 60034-30; 2008

Output kW	Motor type	Product code	Speed r/min	Efficiency IEC 60034-2-1; 2007			Power factor cos φ	Current					Moment of inertia J = 1/4 GD ² kgm ²	Weight kg	Sound pressure level L _{PA} dB
				Full load 100%	3/4 load 75%	1/2 load 50%		I _N A	I _s / I _N	T _N Nm	T _l / T _N	T _b / T _N			
1000 r/min = 6-poles 400 V 50 Hz			GENELEC-design												
0.09	M3AAD 63 A	3GAA 063 311-••C	910	47.1	42.5	32.1	0.56	0.49	2.1	0.94	2.1	2.1	0.0002	4	38
0.12	M3AAD 63 B	3GAA 063 312-••C	910	57.5	54.0	46.2	0.58	0.51	2.1	1.25	2.1	2.1	0.00027	4.5	38
0.18	M3AAD 71 A	3GAA 073 311-••E	895	60.4	60.0	55.0	0.73	0.58	3.1	1.92	1.9	2.0	0.00092	5.5	42
0.25	M3AAD 71 B	3GAA 073 312-••E	895	64.0	63.6	59.5	0.71	0.79	3.3	2.6	2.2	2.2	0.0012	6.5	42
0.37	M3AAD 80 A	3GAA 083 311-••E	910	69.9	71.4	68.8	0.73	1.04	3.6	3.8	1.6	2.0	0.002	9	47
0.55	M3AAD 80 B	3GAA 083 312-••E	905	72.1	73.4	71.2	0.69	1.59	3.3	5.8	1.8	1.9	0.0026	10	47
0.75	M3AAD 90 LB	3GAA 093 313-••E	930	77.6	76.2	75.6	0.71	1.96	4.0	7.7	2.0	2.3	0.0048	18	44
1.1 ²⁾	M3AAD 90 LD	3GAA 093 314-••E	930	78.1	78.6	76.4	0.66	3.0	4.0	11.2	1.9	2.3	0.0056	20	44
1.5	M3AAD 100 LC	3GAA 103 312-••E	945	80.3	81.4	80.7	0.73	3.6	3.9	15.1	1.7	2.0	0.009	26	49
2.2 ²⁾	M3AAD 112 MB	3GAA 113 312-••E	940	81.8	83.1	82.5	0.73	5.3	4.4	22.3	1.8	2.2	0.01	28	56
3	M3AAD 132 S	3GAA 133 311-••E	960	83.3	83.6	81.7	0.65	7.9	4.3	29.8	1.6	2.3	0.031	39	57
4	M3AAD 132 MA	3GAA 133 312-••E	960	84.9	85.3	83.9	0.68	10.0	4.6	39.7	1.5	2.2	0.038	46	61
5.5	M3AAD 132 MC	3GAA 133 314-••E	965	86.1	86.1	84.3	0.67	13.7	6.2	54.4	2.5	2.8	0.049	59	61
7.5	M3AA 160 MLA	3GAA 163 031-••G	975	88.6	89.9	89.7	0.79	15.4	7.4	73.4	1.7	3.2	0.087	98	59
11	M3AA 160 MLB	3GAA 163 032-••G	972	89.3	90.7	90.6	0.79	22.5	7.5	108	1.9	2.9	0.114	125	59
15	M3AA 180 MLA	3GAA 183 031-••G	981	90.5	91.4	91.0	0.77	31.0	6.5	146	1.8	2.8	0.192	162	59
18.5	M3AA 200 MLA	3GAA 203 031-••G	988	91.6	92.3	91.7	0.80	36.4	6.7	178	2.3	2.9	0.382	196	63
22	M3AA 200 MLB	3GAA 203 032-••G	987	92.0	93.0	92.8	0.82	42.0	6.6	212	2.2	2.8	0.448	218	63
30	M3AA 225 SMA	3GAA 223 031-••G	986	92.7	93.3	92.9	0.83	56.2	7.0	290	2.6	2.9	0.663	266	63
37	M3AA 250 SMA	3GAA 253 031-••G	989	93.1	93.8	93.4	0.82	69.9	6.8	357	2.4	2.7	1.13	294	63
45 ¹⁾	M3AA 280 SMA	3GAA 283 031-••G	988	92.9	93.7	93.6	0.83	84.2	6.8	434	2.4	2.6	1.369	378	63
1000 r/min = 6-poles 400 V 50 Hz			High-output design												
0.37	M3AAD 71 C	3GAA 073 003-••E	870	61.5	61.2	59.0	0.72	1.2	3.1	4.0	2.5	2.4	0.0015	7	44
0.75 ¹⁾²⁾	M3AAD 80 C	3GAA 083 003-••E	905	70.1	70.3	69.1	0.76	2.0	3.9	7.9	2.5	2.4	0.0031	11	47
1.3 ¹⁾²⁾	M3AAD 90 LB	3GAA 093 003-••E	910	74.4	72.6	68.7	0.71	3.5	4.0	13.6	1.9	2.2	0.0048	18	44
2.2 ¹⁾²⁾	M3AAD 100 LC	3GAA 103 002-••E	940	78.0	74.0	71.2	0.71	5.7	4.5	22.3	1.9	2.3	0.009	26	49
3 ¹⁾²⁾	M3AAD 112 MB	3GAA 113 102-••E	920	79.7	80.5	80.3	0.75	7.2	3.8	31.1	1.9	2.2	0.0126	32	76
15 ²⁾	M3AA 160 MLC	3GAA 163 033-••G	967	88.7	90.5	90.5	0.76	32.1	6.3	148	2.0	2.9	0.131	138	59
30 ¹⁾²⁾	M3AA 200 MLC	3GAA 203 033-••G	985	91.6	92.8	92.5	0.82	57.6	6.9	290	2.3	2.8	0.531	245	63
37	M3AA 225 SMB	3GAA 223 034-••G	985	93.1	94.0	94.0	0.83	69.1	6.6	358	2.3	2.6	0.821	300	63
45	M3AA 250 SMB	3GAA 253 032-••G	989	93.4	94.1	93.9	0.83	83.7	7.0	434	2.5	2.7	1.369	341	63

¹⁾ Temperature rise class F

²⁾ Efficiency class IE1

The two bullets in the product code indicate choice of mounting arrangements, voltage and frequency code (see ordering information page).

I_s / I_N = Starting current

T_l / T_N = Locked rotor torque

T_b / T_N = Pull-out torque

Efficiency values are given according to IEC 60034-2-1; 2007. Please note that the values are not comparable without knowing the testing method. ABB has calculated the efficiency values according to indirect method, stray load losses (additional losses) determined from measuring.

Dust ignition proof aluminum motors

Technical data for Category 3 D - T = 125°C - IP 55



IP 55 - IC 411 - Insulation class F, temperature rise class B

Output kW	Motor type	Product code	Speed r/min	Efficiency IEC 60034-2-1; 2007			Power factor cos φ	Current _____ Torque _____					Moment of inertia J = 1/4 GD ² kgm ²	Weight kg	Sound pressure level L _{PA} dB
				Full load 100%	3/4 load 75%	1/2 load 50%		I _N A	I _s / I _N	T _N Nm	T _I / T _N	T _b / T _N			
750 r/min = 8-poles 400 V 50 Hz			CENELEC-design												
0.09	M3AAD 71 A	3GAA 074 001-••E	660	49.4	46.0	38.5	0.59	0.44	2.0	1.3	2.4	2.3	0.00092	5.5	40
0.12	M3AAD 71 B	3GAA 074 002-••E	670	51.4	47.5	39.9	0.56	0.6	2.1	1.71	2.8	2.4	0.0012	6.5	43
0.18	M3AAD 80 A	3GAA 084 001-••E	685	63.5	62.0	56.3	0.62	0.65	2.8	2.5	1.6	2.0	0.0018	8.5	45
0.25	M3AAD 80 B	3GAA 084 002-••E	685	67.1	67.2	63.4	0.63	0.85	2.8	3.4	1.4	1.9	0.0024	9.5	50
0.37	M3AAD 90 S	3GAA 094 001-••E	695	59.4	56.3	49.1	0.54	1.66	2.7	5.0	1.6	2.1	0.0032	13	52
0.55	M3AAD 90 L	3GAA 094 002-••E	660	59.1	59.5	55.2	0.58	2.3	2.1	7.9	1.5	1.6	0.0043	16	52
0.75	M3AAD 100 LA	3GAA 104 001-••E	720	70.7	67.1	59.9	0.47	3.2	3.9	9.9	2.8	3.6	0.0069	20	46
1.1	M3AAD 100 LB	3GAA 104 002-••E	695	76.0	76.5	74.6	0.66	3.1	3.4	15.1	1.7	2.2	0.0082	23	53
1.5	M3AAD 112 M	3GAA 114 101-••E	690	74.4	75.9	74.1	0.70	4.1	3.2	20.7	1.4	1.9	0.01	28	55
2.2	M3AAD 132 S	3GAA 134 001-••E	715	82.9	83.0	80.8	0.62	6.1	3.4	29.3	1.3	1.9	0.0038	46	56
3	M3AAD 132 M	3GAA 134 002-••E	715	79.9	80.8	79.1	0.64	8.4	3.2	40.0	1.2	1.8	0.0045	53	58
4	M3AA 160 MLA	3GAA 164 031-••G	728	84.1	85.1	83.7	0.67	10.2	5.4	52.4	1.5	2.6	0.068	84	59
5.5	M3AA 160 MLB	3GAA 164 032-••G	726	84.7	86.0	84.9	0.67	13.9	5.6	72.3	1.4	2.6	0.085	98	59
7.5	M3AA 160 MLC	3GAA 164 033-••G	727	86.1	87.3	86.6	0.65	19.3	4.7	98.5	1.5	2.8	0.132	137	59
11	M3AA 180 MLA	3GAA 184 031-••G	731	86.8	88.4	87.8	0.67	27.3	4.4	143	1.8	2.6	0.214	175	59
15	M3AA 200 MLA	3GAA 204 031-••G	737	90.2	91.3	90.9	0.74	32.4	5.3	194	2.0	2.4	0.45	217	60
18.5	M3AA 225 SMA	3GAA 224 031-••G	739	91.0	92.0	91.5	0.73	40.1	5.2	239	2.0	2.3	0.669	266	63
22	M3AA 225 SMB	3GAA 224 032-••G	738	91.6	92.4	92.0	0.74	46.8	5.5	284	2.0	2.3	0.722	279	63
30	M3AA 250 SMA	3GAA 254 031-••G	742	92.4	92.9	92.3	0.71	66.0	5.8	386	2.6	2.4	1.404	340	63
37	M3AA 280 SMA	3GAA 284 031-••G	740	92.3	93.0	92.7	0.74	78.1	5.6	477	2.4	2.3	1.505	403	63
750 r/min = 8-poles 400 V 50 Hz			High-output design												
0.18 ¹⁾	M3AAD 71 C	3GAA 074 003-••E	660	47.2	44.8	45.0	0.66	0.83	2.2	2.6	2.3	2.2	0.0015	7	40
0.37 ¹⁾	M3AAD 80 C	3GAA 084 003-••E	700	57.5	56.0	55.0	0.62	1.49	3.3	5.0	2.5	2.5	0.0031	11	45
0.75 ¹⁾	M3AAD 90 LB	3GAA 094 003-••E	680	63.1	59.8	53.0	0.60	2.8	3.0	10.5	1.8	2.0	0.0048	18	43
1.5 ¹⁾	M3AAD 100 LC	3GAA 104 003-••E	670	70.0	65.2	63.8	0.70	4.4	3.3	21.3	1.8	2.2	0.009	26	46
2 ¹⁾	M3AAD 112 MB	3GAA 114 102-••E	685	73.2	72.5	70.0	0.69	5.7	3.4	27.8	2.1	2.3	0.0126	32	52

¹⁾ Temperature rise class F

The two bullets in the product code indicate choice of mounting arrangements, voltage and frequency code (see ordering information page).

I_s / I_N = Starting current
 T_I / T_N = Locked rotor torque
 T_b / T_N = Pull-out torque

Efficiency values are given according to IEC 60034-2-1; 2007. Please note that the values are not comparable without knowing the testing method. ABB has calculated the efficiency values according to indirect method, stray load losses (additional losses) determined from measuring.

Dust ignition proof Ex tD (DIP) cast iron motors variant codes

Code ¹⁾	Variant	Frame size													
		80	90	100	112	132	160	180	200	225	250	280	315	355	400
Administration															
531	Sea freight packing	M	M	M	M	M	M	M	M	M	M	M	M	M	P
Balancing															
417	Vibration acc. to Grade B (IEC 60034-14).	P	P	P	P	P	P	P	P	P	P	P	P	P	R
423	Balanced without key	P	P	P	P	P	P	P	P	P	P	P	P	P	P
424	Full key balancing.	P	P	P	P	P	P	P	P	P	P	P	P	P	P
Bearings and Lubrication															
036	Transport lock for bearings.	NA	NA	NA	NA	NA	M	M	M	M	M	M	M	M	P
037	Roller bearing at D-end.	NA	NA	NA	NA	NA	M	M	M	M	M	M	M	M	P
040	Heat resistant grease.	S	S	S	S	S	P	P	P	P	P	P	P	P	P
041	Bearings regreasable via grease nipples.	NA	NA	NA	NA	NA	S	S	S	S	S	S	S	S	S
058	Angular contact bearing at D-end, shaft force away from bearing.	NA	NA	NA	NA	NA	P	P	P	P	P	P	P	P	P
059	Angular contact bearing at N-end, shaft force towards bearing.	NA	NA	NA	NA	NA	P	P	P	P	P	P	P	P	P
060	Angular contact bearing at D-end, shaft force towards bearing.	NA	NA	NA	NA	NA	NA	NA	NA	NA	NA	P	P	P	P
061	Angular contact bearing at N-end, shaft force away from bearing.	NA	NA	NA	NA	NA	NA	NA	NA	NA	NA	P	P	P	P
107	Pt100 2-wire in bearings.	NA	NA	NA	NA	NA	P	P	P	P	P	P	P	P	P
128	Double PT100, 2-wire in bearings	NA	NA	NA	NA	NA	P	P	P	P	P	P	P	P	P
129	Double PT100, 3-wire in bearings	NA	NA	NA	NA	NA	P	P	P	P	P	P	P	P	P
130	Pt100 3-wire in bearings.	NA	NA	NA	NA	NA	P	P	P	P	P	P	P	P	P
194	2Z bearings greased for life at both ends.	S	S	S	S	S	M	M	M	M	M	NA	NA	NA	NA
433	Outlet grease collector	NA	NA	NA	NA	NA	NA	NA	NA	NA	NA	P	P	P	P
506	Nipples for vibration measurement : SKF Marlin Quick Connect stud CMSS-2600-3	NA	NA	NA	NA	NA	P	P	P	P	P	P	P	P	P
654	Provision for vibration sensors (M8x1)	NA	NA	NA	NA	NA	P	P	P	P	P	P	P	P	P
795	Lubrication information plate	NA	NA	NA	NA	NA	M	M	M	M	M	S	S	S	S
796	Grease nipples JIS B 1575 PT 1/8 Type A	NA	NA	NA	NA	NA	P	P	P	P	P	P	P	P	P
797	Stainless steel SPM Nipples	NA	NA	NA	NA	NA	P	P	P	P	P	P	P	P	P
798	Stainless steel grease nipples	NA	NA	NA	NA	NA	P	P	P	P	P	P	P	P	P
799	Grease nipples flat type DIN 3404, thread M10x1	NA	NA	NA	NA	NA	M	M	M	M	M	M	M	M	P
800	Grease nipples JIS B 1575 PT 1/8" pin type	NA	NA	NA	NA	NA	P	P	P	P	P	P	P	P	P
Branch standard designs															
178	Stainless steel / acid proof bolts.	S	S	S	S	S	M	M	M	M	M	M	M	M	P
204	Jacking bolts for foot mounted motors.	NA	NA	NA	NA	NA	P	P	P	P	P	P	P	S	S
209	Non-standard voltage or frequency, (special winding).	P	P	P	P	P	P	P	P	P	P	P	P	P	P
396	Motor designed for ambient temperature -20°C to -40°C, with space heaters (code 450/451 must be added).	P	P	P	P	P	P	P	P	P	P	P	P	P	P
397	Motor designed for ambient temperature -40°C to -55°C, with space heaters (code 450/451 must be added).	P	P	P	P	P	P	P	P	P	P	P	P	P	P
398	Motor designed for ambient temperature -20°C to -40°C.	P	P	P	P	P	P	P	P	P	P	P	P	P	P
399	Motor designed for ambient temperature -40°C to -55°C.	P	P	P	P	P	P	P	P	P	P	P	P	P	P

¹⁾ Certain variant codes cannot be used simultaneously.

S = Included as standard
P = New manufacture only
M = On modification of a stocked motor; or on new manufacture, the number of number per order may be limited.
R = On request
NA = Not applicable.

Code ¹⁾	Variant	Frame size													
		80	90	100	112	132	160	180	200	225	250	280	315	355	400
425	Corrosion protected stator and rotor core.	S	S	S	S	S	S	S	S	S	S	P	P	P	P
786	Special design shaft upwards (V3, V36, V6) for outdoor mounting.	P	P	P	P	P	P	P	P	P	P	R	R	NA	NA
Cooling system															
044	Unidirectional fan for reduced noise level. Rotation clockwise seen from D-end. Available only for 2-pole motors.	NA	NA	NA	NA	NA	NA	NA	NA	NA	NA	P	P	P	S
045	Unidirectional fan for reduced noise level. Rotation counter clockwise seen from D-end. Available only for 2-pole motors.	NA	NA	NA	NA	NA	NA	NA	NA	NA	NA	P	P	P	S
068	Light alloy metal fan	M	M	M	M	M	M	M	M	M	M	M	M	M	P
183	Separate motor cooling (fan axial, N-end).	NA	NA	NA	NA	NA	P	P	P	P	P	P	P	P	P
206	Steel fan	NA	NA	NA	NA	NA	P	P	P	P	P	P	P	P	P
422	Separate motor cooling (fan top, N-end).	NA	NA	NA	NA	NA	NA	NA	NA	NA	NA	P	P	P	P
791	Stainless steel fan cover	NA	NA	NA	NA	NA	NA	NA	NA	P	P	P	P	P	P
Coupling															
035	Assembly of customer supplied coupling-half.	NA	NA	NA	NA	NA	NA	NA	NA	NA	NA	P	P	P	P
Documentation															
141	Binding dimension drawing.	M	M	M	M	M	M	M	M	M	M	M	M	M	P
Drain holes															
065	Plugged existing drain holes.	NA	NA	NA	NA	NA	M	M	M	M	M	M	M	M	P
448	Draining holes with metal plugs.	NA	NA	NA	NA	NA	P	P	P	P	P	P	P	P	P
Hazardous Environments															
452	DIP/Ex tD acc. to ATEX directive 94/9/EC, T= 125°C, cat. 3D, IP55	M	M	M	M	M	M	M	M	M	M	M	M	M	P
453	DIP/Ex tD acc. to ATEX directive 94/9/EC, T= 125°C, cat. 2D, IP65	M	M	M	M	M	M	M	M	M	M	M	M	P	P
454	DIP/Ex tD acc. to ATEX directive 94/9/EC, T= 125°C, cat. 3D, IP65	M	M	M	M	M	M	M	M	M	M	M	P	P	P
804	DIP/Ex tD, IEC 61241, T125°C, IP55 (zone 22).	M	M	M	M	M	M	M	M	M	M	M	M	M	P
805	DIP/Ex tD, IEC 61241, T125°C, IP65 (zone 21).	P	P	P	P	P	M	M	M	M	M	P	P	P	P
806	DIP/Ex tD, IEC 61241, T125°C, IP65 (zone 22).	P	P	P	P	P	M	M	M	M	M	P	P	P	P
807	CSA design, Class I, Div 2 Group A, B, C, D T3	NA	NA	NA	NA	NA	NA	NA	P	P	P	P	P	P	P
814	Ex tD (DIP) motors, temperature class T 150C.	M	M	M	M	M	M	M	M	M	M	M	M	P	P
Heating elements															
450	Heating element, 100-120V.	M	M	M	M	M	M	M	M	M	M	M	M	M	P
451	Heating element, 200-240V.	M	M	M	M	M	M	M	M	M	M	M	M	M	P
Insulation system															
014	Winding insulation class H.	P	P	P	P	P	P	P	P	P	P	P	P	P	P
405	Special winding insulation for frequency converter supply.	P	P	P	P	P	P	P	P	P	P	P	P	P	P
Mounting arrangements															
008	IM 2101 foot/flange mounted, IEC flange, from IM 1001 (B34 from B3).	M	M	M	M	M	NA	NA	NA	NA	NA	NA	NA	NA	NA
009	IM 2001 foot/flange mounted, IEC flange, from IM 1001 (B35 from B3).	M	M	M	M	M	M	M	M	M	M	M	M	M	P
047	IM 3601 flange mounted, IEC flange, from IM 3001 (B14 from B5).	M	M	M	M	M	NA	NA	NA	NA	NA	NA	NA	NA	NA

¹⁾ Certain variant codes cannot be used simultaneously.

S = Included as standard
P = New manufacture only
M = On modification of a stocked motor; or on new manufacture, the number of number per order may be limited.
R = On request
NA = Not applicable.

Code ¹⁾	Variant	Frame size													
		80	90	100	112	132	160	180	200	225	250	280	315	355	400
066	Modified for non-standard mounting position (please specify IM xxxx), (must be ordered for all mounting arrangements excluding IM B3 (1001), IM B5 (3001), IM B35 (2001), B34 (2101) & B14 (3601).	M	M	M	M	M	M	M	M	M	M	M	M	P	P
228	Flange FF 130.	P	P	P	P	NA	NA	NA	NA	NA	NA	NA	NA	NA	NA
229	Flange FT 130.	M	P	NA	NA	NA	NA	NA	NA	NA	NA	NA	NA	NA	NA
305	Additional lifting lugs.	NA	NA	NA	NA	NA	NA	NA	NA	NA	NA	P	P	P	P
Painting															
111	Painting system C3M acc. to ISO 12944-5: 2007	S	S	S	S	S	S	S	S	S	S	S	S	S	S
114	Special paint colour, standard grade.	M	M	M	M	M	M	M	M	M	M	M	M	M	P
115	Painting system C4M acc. To ISO 12944-5: 2007	P	P	P	P	P	P	P	P	P	P	P	P	P	P
168	Primer paint only.	P	P	P	P	P	P	P	P	P	P	P	P	P	P
754	Painting system C5M acc. to ISO 12944-5: 2007	P	P	P	P	P	P	P	P	P	P	P	P	P	P
755	Aluminium metallizing and painting according to NORSOK M501 revision 5, Method 2A (only available color RAL 7038)	P	P	P	P	P	P	P	P	P	P	P	P	P	P
Protection															
005	Metal protective roof, vertical motor, shaft down.	M	M	M	M	M	M	M	M	M	M	M	M	M	P
072	Radial seal at D-end.	M	M	M	M	M	M	M	M	M	M	M	M	NA	NA
073	Sealed against oil at D-end.	P	P	P	P	P	P	P	P	P	P	P	P	P	P
076	Draining holes with plugs in open position.	P	P	P	P	P	S	S	S	S	S	S	S	S	S
158	Degree of protection IP65.	M	M	M	M	M	M	M	M	M	M	M	M	M	P
401	Protective roof, horizontal motor.	P	P	P	P	P	P	P	P	P	P	P	P	P	P
403	Degree of protection IP56.	M	M	M	M	M	M	M	M	M	M	M	M	M	P
434	Degree of protection IP56, open deck.	NA	NA	NA	NA	NA	P	P	P	P	P	P	P	P	P
783	Labyrinth sealing at D-end.	P	P	P	P	P	P	P	P	P	P	P	P	S	S
Rating & instruction plates															
002	Restamping voltage, frequency and output, continuous duty.	M	M	M	M	M	M	M	M	M	M	M	M	M	P
004	Additional text on std rating plate (max 12 digits on free text line).	P	P	P	P	P	P	P	P	P	P	P	P	P	P
095	Restamping output (maintained voltage, frequency), intermittent duty.	P	P	P	P	P	P	P	P	P	P	P	P	P	P
098	Stainless rating plate.	S	S	S	S	S	S	S	S	S	S	S	S	S	S
126	Tag plate	P	P	P	P	P	P	P	P	P	P	P	P	P	P
135	Mounting of additional identification plate, stainless.	M	M	M	M	M	M	M	M	M	M	M	M	M	P
139	Additional identification plate delivered loose.	M	M	M	M	M	M	M	M	M	M	M	M	M	P
161	Additional rating plate delivered loose.	M	M	M	M	M	M	M	M	M	M	M	M	M	P
163	Frequency converter rating plate. Rating data according to quotation.	M	M	M	M	M	M	M	M	M	M	M	M	M	P
Shaft & rotor															
069	Two shaft extensions as per basic catalogue.	P	P	P	P	P	P	P	P	P	P	P	P	P	P
070	One or two special shaft extensions, standard shaft material.	P	P	P	P	P	P	P	P	P	P	P	P	P	P
164	Shaft extension with closed key-way.	S	S	S	S	S	S	S	S	S	S	P	P	P	P
165	Shaft extension with open key-way.	P	P	P	P	P	P	P	P	P	P	S	S	S	S
410	Stainless steel shaft (standard or non-standard design).	NA	NA	NA	NA	NA	R	R	R	R	R	P	P	P	P

¹⁾ Certain variant codes cannot be used simultaneously.

S = Included as standard
P = New manufacture only
M = On modification of a stocked motor; or on new manufacture, the number of number per order may be limited.
R = On request
NA = Not applicable.

Code ¹⁾	Variant	Frame size													
		80	90	100	112	132	160	180	200	225	250	280	315	355	400
Standards and Regulations															
151	Design according to SHELL DEP 33.66.05.31-Gen. June 2007	M	M	M	M	M	M	M	M	M	M	P	P	P	P
421	VIK design (Verband der Industriellen Energie- und Kraftwirtschaft e.V.).	P	P	P	P	P	P	P	M	M	M	P	P	P	P
482	Design according to Neste OY & Jacobs, specification N-114 E, rev 3, 21.03.2002	P	P	P	P	P	P	P	P	P	P	P	P	P	P
504	Design according to Neste OY & Jacobs, specification N-114 E, rev 3, 21.03.2002 with SPM adapter	P	P	P	P	P	P	P	P	P	P	P	P	P	P
505	VIK design with ABB standard shaft dimensions (Verband der Industriellen Energie- und Kraftwirtschaft e.V.).	P	P	P	P	P	P	P	P	P	P	P	P	P	P
540	China energy label	P	P	P	P	P	M	M	M	M	M	M	M	M	NA
676	Fulfilling Germanischer Lloyd (GL) requirements, without certificate	M	M	M	M	M	M	M	M	M	M	M	P	P	P
775	Design according to SHELL DEP 33.66.05.31-Gen. January 1999 design.	M	M	M	M	M	M	M	M	M	M	P	P	P	P
778	GOST Export/Import Certificate (Russia). (must be ordered variant code 812)	P	P	P	P	P	P	P	P	P	P	P	P	NA	NA
779	SASO Export/Import Certificate (Saudi Arabia)	NA	NA	NA	NA	NA	M	M	M	M	M	M	M	P	P
782	Fulfilling CQST Certification requirements (China)	M	M	M	M	M	M	M	M	M	M	M	M	P	P
788	Documentation for Korean KOSHA certification	P	P	P	P	P	P	P	P	P	P	M	P	P	P
802	GOST Kazakhstan certified	P	P	P	P	P	P	P	P	P	P	P	P	P	P
Stator winding temperature sensors															
120	KTY 84-130 (1 per phase) in stator winding.	NA	NA	NA	NA	NA	P	P	P	P	P	P	P	P	P
328	PTC - thermistors (3 in series), 120°C, in stator winding	M	M	M	M	M	M	M	M	M	M	M	M	M	P
435	PTC - thermistors (3 in series), 130°C, in stator winding.	M	M	M	M	M	M	M	M	M	M	M	M	M	P
436	PTC - thermistors (3 in series), 150°C, in stator winding.	NA	NA	NA	NA	NA	NA	NA	NA	NA	NA	S	S	S	S
439	PTC - thermistors (2x3 in series), 150°C, in stator winding.	P	P	P	P	P	M	M	M	M	M	M	M	M	P
441	PTC - thermistors (3 in series, 130°C & 3 in series, 150°C), in stator winding.	P	P	P	P	P	P	P	P	P	P	P	P	P	P
445	Pt-100 2-wire in stator winding, 1 per phase	P	P	P	P	P	P	P	P	P	P	P	P	P	P
446	Pt-100 2-wire in stator winding, 2 per phase	NA	NA	NA	NA	NA	P	P	P	P	P	P	P	P	P
502	Pt-100 3-wire in stator winding, 1 per phase.	NA	NA	NA	NA	NA	P	P	P	P	P	P	P	P	P
503	Pt-100 3-wire in stator winding, 2 per phase.	NA	NA	NA	NA	NA	P	P	P	P	P	P	P	P	P
Terminal box															
19	Larger than standard terminal box.	NA	NA	NA	NA	NA	NA	NA	NA	NA	NA	P	P	P	P
21	Terminal box LHS (seen from D-end).	NA	NA	NA	NA	NA	P	P	P	P	P	P	P	P	P
22	Cable entry LHS (seen from D-end).	M	M	M	M	M	M	M	M	M	M	M	M	M	P

¹⁾ Certain variant codes cannot be used simultaneously.

S = Included as standard

P = New manufacture only

M = On modification of a stocked motor; or on new manufacture, the number of number per order may be limited.

R = On request

NA = Not applicable.

Code ¹⁾	Variant	Frame size													
		80	90	100	112	132	160	180	200	225	250	280	315	355	400
136	Extended cable connection, standard terminal box.	NA	NA	NA	NA	NA	NA	NA	NA	NA	NA	NA	NA	NA	NA
157	Terminal box degree of protection IP65.	M	M	M	M	M	M	M	M	M	M	M	M	M	P
180	Terminal box RHS (seen from D-end).	NA	NA	NA	NA	NA	P	P	P	P	P	P	P	P	P
231	Standard cable glands with clamping device.	NA	NA	NA	NA	NA	NA	NA	NA	NA	NA	NA	NA	NA	P
277	Cable sealing end unit, size small for C-opening	NA	NA	NA	NA	NA	NA	NA	NA	NA	NA	P	NA	NA	NA
278	Cable sealing end unit, size medium for D-opening	NA	NA	NA	NA	NA	NA	NA	NA	NA	NA	NA	P	P	P
279	Cable sealing end unit, size large for D-opening	NA	NA	NA	NA	NA	NA	NA	NA	NA	NA	NA	P	P	P
292	Adapter C-C	NA	NA	NA	NA	NA	NA	NA	NA	NA	NA	P	NA	NA	NA
293	Adapter D-D	NA	NA	NA	NA	NA	NA	NA	NA	NA	NA	NA	P	P	NA
294	Adapter E-D	NA	NA	NA	NA	NA	NA	NA	NA	NA	NA	NA	P	P	P
295	Adapter E-2D	NA	NA	NA	NA	NA	NA	NA	NA	NA	NA	NA	P	P	P
300	Increased single core cross section	P	P	P	P	P	P	P	P	P	P	P	P	P	P
380	Separate terminal box for temperature detectors, std. material	NA	NA	NA	NA	NA	P	P	P	P	P	P	P	P	P
400	4 x 90 degr turnable terminal box.	S	S	S	S	S	S	S	S	S	S	S	S	NA	NA
402	Terminal box adapted for Al cables.	NA	NA	NA	NA	NA	NA	NA	NA	NA	NA	S	S	S	S
413	Extended cable connection, no terminal box.	NA	NA	NA	NA	NA	P	P	P	P	P	P	P	P	P
418	Separate terminal box for auxiliaries, standard material.	NA	NA	NA	NA	NA	P	P	P	P	P	P	P	P	P
447	Top mounted separate terminal box for monitoring equipment.	NA	NA	NA	NA	NA	NA	NA	NA	NA	NA	M	M	M	NA
466	Terminal box at N-end.	NA	NA	NA	NA	NA	NA	NA	P	P	P	P	P	P	P
468	Cable entry from D-end.	M	M	M	M	M	M	M	M	M	M	M	M	P	P
469	Cable entry from N-end.	M	M	M	M	M	M	M	M	M	M	M	M	P	P
567	Separate terminal box material: Cast Iron	NA	NA	NA	NA	NA	P	P	P	P	P	P	P	P	P
568	Separate terminal box for heating elements, std. material	NA	NA	NA	NA	NA	P	P	P	P	P	P	P	P	P
569	Separate terminal box for brakes	NA	NA	NA	NA	NA	P	P	P	P	P	NA	NA	NA	NA
728	Standard cable gland, Ex d IIB, armoured cable, double sealing.	P	P	P	P	P	P	P	P	P	P	P	P	P	P
730	Prepared for NPT cable glands	P	P	P	P	P	P	P	P	P	P	P	P	P	P
732	Standard cable gland, Ex d IIB, armoured cable.	M	M	M	M	M	M	M	M	M	M	M	P	P	P
733	Standard cable gland, Ex d IIB, non-armoured cable.	NA	NA	NA	NA	NA	P	P	P	P	P	P	P	P	P
734	Standard cable gland, Ex d IIC, armoured cable.	M	M	M	M	M	M	M	M	M	M	M	P	P	P
736	Standard cable gland, Ex e acc. to EN-standards.	S	S	S	S	S	S	S	S	S	S	S	S	S	S
737	Standard cable gland, Ex e with clamping device acc. to EN-standards.	P	P	P	P	P	P	P	P	P	P	P	P	P	P
741	Motor equipped with Ex e terminal box (EN 50019).	P	P	P	P	P	P	P	P	P	P	P	P	P	P
743	Painted non-drilled flange in steel for cable glands	P	P	P	P	P	M	M	M	M	M	M	M	M	P

¹⁾ Certain variant codes cannot be used simultaneously.

S = Included as standard
P = New manufacture only
M = On modification of a stocked motor; or on new manufacture, the number of number per order may be limited.
R = On request
NA = Not applicable.

Code ¹⁾	Variant	Frame size													
		80	90	100	112	132	160	180	200	225	250	280	315	355	400
744	Stainless steel non-drilled flange for cable glands.	P	P	P	P	P	M	M	M	M	M	M	M	M	P
745	Painted steel flange equipped with nickle plated brass cable glands	P	P	P	P	P	M	M	M	M	M	M	M	M	P
746	Stainless steel cable flange equipped with standard nickle plated brass cable glands	P	P	P	P	P	P	P	P	P	P	P	P	P	P

Testing

145	Type test report from a catalogue motor, 400V 50Hz.	M	M	M	M	M	M	M	M	M	M	M	M	M	P
146	Type test with report for one motor from specific delivery batch.	P	P	P	P	P	P	P	P	P	P	P	P	P	P
148	Routine test report.	M	M	M	M	M	M	M	M	M	M	M	M	M	P
150	Customer witnessed testing. Specify test procedure with other codes.	P	P	P	P	P	P	P	P	P	P	P	P	P	P
222	Torque/speed curve, type test and multi-point load test with report for one motor from specific delivery batch.	P	P	P	P	P	P	P	P	P	P	P	P	P	P
760	Vibration level test	P	P	P	P	P	M	M	M	M	M	M	M	M	P
761	Vibration spectrum test for one motor from specific delivery batch.	P	P	P	P	P	P	P	P	P	P	P	P	P	P
762	Noise level test for one motor from specific delivery batch.	P	P	P	P	P	P	P	P	P	P	P	P	P	P
763	Noise spectrum test for one motor from specific delivery batch.	P	P	P	P	P	P	P	P	P	P	P	P	P	P
764	Test for one motor from specific delivery batch with ABB frequency converter available at ABB test field. ABB standard test procedure.	P	P	P	P	P	P	P	P	P	P	P	P	P	P

Variable speed drives

181	Rating plate with ABB standard loadability values for VSD operation. Other auxiliaries for VSD operation to be selected as necessary.	M	M	M	M	M	M	M	M	M	M	P	P	P	NA
470	Prepared for hollow shaft pulse tacho (L&L equivalent).	NA	NA	NA	NA	NA	P	P	P	P	P	P	P	P	P
479	Mounting of other type of pulse tacho with shaft extension, tacho not included.	NA	NA	NA	NA	NA	R	R	R	R	R	P	P	P	P
680	2048 pulse tacho, Ex d, tD, L&L 841910001	NA	NA	NA	NA	NA	P	P	P	P	P	P	P	P	P
701	Insulated bearing at N-end.	NA	NA	NA	NA	NA	NA	NA	NA	NA	NA	M	M	M	P
704	EMC cable gland.	P	P	P	P	P	P	P	P	P	P	P	P	P	P
747	1024 pulse tacho, Ex d, tD, L&L 841910002	NA	NA	NA	NA	NA	P	P	P	P	P	P	P	P	P

Y/Δ starting

117	Terminals for Y/Δ start at both speeds (two speed windings).	NA	NA	NA	NA	NA	R	R	R	R	R	P	P	R	R
118	Terminals for Y/Δ start at high speed (two speed windings).	NA	NA	NA	NA	NA	R	R	R	R	R	P	P	R	R
119	Terminals for Y/Δ start at low speed (two speed windings).	NA	NA	NA	NA	NA	R	R	R	R	R	P	P	R	R

¹⁾ Certain variant codes cannot be used simultaneously.

S = Included as standard

P = New manufacture only

M = On modification of a stocked motor; or on new manufacture, the number of number per order may be limited.

R = On request

NA = Not applicable.

Dust ignition proof Ex tD (DIP) aluminum motors variant codes

Code ¹⁾	Variant	Frame size												
		63	71	80	90	100	112	132	160	180	200	225	250	280
Balancing														
417	Vibration acc. to Grade B (IEC 60034-14).	NA	NA	NA	P	P	P	P	R	P	R	R	R	R
423	Balanced without key.	NA	NA	NA	P	P	P	P	R	R	R	R	R	R
424	Full key balancing.	NA	NA	NA	P	P	P	P	P	P	P	P	P	P
Bearings and Lubrication														
036	Transport lock for bearings.	NA	NA	NA	M	M	M	M	M	M	M	M	M	M
037	Roller bearing at D-end.	NA	NA	NA	P	P	P	P	M	M	M	M	M	M
038	Ball bearing at D-end.	NA	NA	NA	NA	NA	NA	NA	S	S	S	S	S	S
039	Cold resistant grease.	M	M	M	M	M	M	M	R	R	R	R	R	M
040	Heat resistant grease.	M	M	M	M	M	M	M	S	S	S	S	S	S
041	Bearings regreasable via grease nipples.	NA	NA	NA	P	P	P	P	M	M	S	S	S	S
042	Locked drive-end.	S	S	S	S	S	S	S	S	S	S	S	S	S
043	SPM compatible nipples for vibration measurement	NA	NA	NA	R	R	R	R	M	M	M	M	M	M
057	2RS bearings at both ends.	M	M	M	M	M	M	M	M	M	M	M	M	M
058	Angular contact bearing at D-end, shaft force away from bearing.	NA	NA	NA	M	M	M	M	M	M	M	M	M	M
059	Angular contact bearing at N-end, shaft force towards bearing.	NA	NA	NA	M	M	M	M	M	M	M	M	M	M
061	Angular contact bearing at N-end, shaft force away from bearing.	NA	NA	NA	NA	NA	NA	NA	NA	NA	P	NA	NA	NA
188	63-series bearings.	NA	NA	NA	M	S	M	M	S	S	S	S	S	S
194	2Z bearings greased for life at both ends.	S	S	S	NA	NA	NA	NA	S	S	R	R	R	R
195	Bearings greased for life.	S	S	S	NA	NA	NA	NA	S	S	R	R	R	R
796	Grease nipples JIS B 1575 PT 1/8 Type A	NA	NA	NA	NA	NA	NA	NA	M	M	M	M	M	M
797	Stainless steel SPM Nipples	NA	NA	NA	R	R	R	R	M	M	M	M	M	M
798	Stainless steel grease nipples	NA	NA	NA	NA	NA	NA	NA	M	M	M	M	M	M
Branch standard designs														
071	Cooling Tower duty	NA	NA	NA	NA	NA	R	R	P	P	P	P	P	P
142	Manilla connection.	NA	NA	NA	P	P	P	P	P	P	P	P	P	P
170	Smoke Venting specification, 200°C, 2 hours	NA	NA	NA	NA	NA	NA	NA	P	P	P	P	P	NA
171	Smoke Venting specification, 300°C, 1/2 hour	NA	NA	NA	NA	NA	NA	NA	P	P	P	P	P	NA
178	Stainless steel / acid proof bolts.	M	M	M	M	M	M	M	M	M	M	M	M	M
199	Extreme heavy duty design.	NA	NA	NA	NA	NA	NA	NA	M	M	M	M	M	M
209	Non-standard voltage or frequency, (special winding).	P	P	P	P	P	P	P	P	P	P	P	P	P
217	Cast iron D-end shield (on aluminum motor).	NA	NA	NA	M	M	M	M	M	M	M	M	M	S
425	Corrosion protected stator and rotor core.	P	P	P	P	P	P	P	P	P	P	P	P	P
Cooling system														
053	Metal fan cover.	S	M	M	M	M	M	M	S	S	S	S	S	S
068	Light alloy metal fan	R	M	M	M	M	M	M	M	M	M	M	M	M
075	Cooling method IC418 (without fan).	R	R	R	P	P	P	P	M	M	M	M	M	M
183	Separate motor cooling (fan axial, N-end).	NA	M	M	M	M	M	P	M	M	M	M	M	M
189	Separate motor cooling, IP44, 400V, 50Hz (fan axial, N-end).	NA	NA	NA	NA	NA	NA	NA	M	M	M	M	M	M
Documentation														
141	Binding dimension drawing.	R	R	R	R	R	R	R	M	M	M	M	M	M
Drain holes														
065	Plugged existing drain holes.	M	M	M	M	M	M	M	M	M	M	M	M	M

¹⁾ Certain variant codes cannot be used simultaneously.

S = Included as standard
P = New manufacture only
M = On modification of a stocked motor; or on new manufacture, the number of number per order may be limited.
R = On request
NA = Not applicable.

Code ¹⁾	Variant	Frame size												
		63	71	80	90	100	112	132	160	180	200	225	250	280
Earthing Bolt														
067	External earthing bolt.	M	M	M	M	M	M	M	M	M	M	M	M	M
Hazardous Environments														
273	Ex e II acc. to ATEX directive 94/9/EC, temp. class T3.	P	P	P	P	P	P	P	NA	NA	NA	NA	NA	NA
452	DIP/Ex tD acc. to ATEX directive 94/9/EC , T= 125°C, cat. 3D, IP55	M	M	M	M	M	M	M	M	M	M	M	M	M
453	DIP/Ex tD acc. to ATEX directive 94/9/EC , T= 125°C, cat. 2D, IP65	P	P	P	P	P	M	M	M	M	M	M	M	M
454	DIP/Ex tD acc. to ATEX directive 94/9/EC , T= 125°C, cat. 3D, IP65	NA	NA	NA	NA	NA	NA	NA	M	M	M	M	M	M
456	Ex nA design, fulfilling IEC 60079-15, with certificate.	NA	NA	NA	NA	NA	NA	NA	M	M	M	M	M	NA
457	Ex nA design, fulfilling IEC 60079-15, without certificate.	NA	NA	NA	NA	NA	NA	NA	NA	NA	NA	NA	NA	NA
480	Ex nA II acc. to ATEX directive 94/9/EC, temp. class T3.	M	M	M	M	M	M	M	M	M	M	M	M	M
804	DIP/Ex tD, IEC 61241, T125°C, IP55 (zone 22).	NA	NA	NA	NA	NA	NA	NA	M	M	M	M	M	NA
805	DIP/Ex tD, IEC 61241, T125°C, IP65 (zone 21).	NA	NA	NA	NA	NA	NA	NA	M	M	M	M	M	NA
Heating elements														
450	Heating element, 100-120V.	M	M	M	M	M	M	M	M	M	M	M	M	M
451	Heating element, 200-240V.	M	M	M	M	M	M	M	M	M	M	M	M	M
Insulation system														
014	Winding insulation class H.	R	R	R	P	P	P	P	P	P	P	P	P	P
405	Special winding insulation for frequency converter supply.	R	R	R	P	P	P	P	P	P	P	P	P	P
406	Winding for supply >690<=1000 Volts.	NA	NA	NA	NA	NA	NA	NA	R	R	P	P	P	P
Mounting arrangements														
007	IM 3001 flange mounted, IEC flange, from IM 1001 (B5 from B3).	NA	NA	NA	NA	NA	NA	NA	NA	NA	M	M	M	M
008	IM 2101 foot/flange mounted, IEC flange, from IM 1001 (B34 from B3).	M	M	M	M	M	M	M	M	NA	NA	NA	NA	NA
009	IM 2001 foot/flange mounted, IEC flange, from IM 1001 (B35 from B3).	M	M	M	M	M	M	M	M	M	M	M	M	M
047	IM 3601 flange mounted, IEC flange, from IM 3001 (B14 from B5).	M	M	M	M	M	M	M	NA	NA	NA	NA	NA	NA
048	IM 3001 flange mounted, IEC flange, from IM 3601 (B5 from B14).	M	M	M	M	M	M	M	NA	NA	NA	NA	NA	NA
066	Modified for non-standard mounting position (please specify IM xxxx), (must be ordered for all mounting arrangements excluding IM B3 (1001), IM B5 (3001), IM B35 (2001), B34 (2101) & B14 (3601).	M	M	M	M	M	M	M	M	M	M	M	M	M
200	Flange ring holder.	NA	M	M	M	M	M	M	R	R	R	R	R	R
218	Flange ring FT 85.	NA	M	M	M	NA	NA	NA	NA	NA	NA	NA	NA	NA
219	Flange ring FT 100.	NA	M	M	M	NA	NA	NA	NA	NA	NA	NA	NA	NA
220	Flange ring FF 100.	NA	M	M	M	NA	NA	NA	NA	NA	NA	NA	NA	NA
223	Flange ring FF 115.	NA	M	M	M	NA	NA	NA	NA	NA	NA	NA	NA	NA
224	Flange ring FT 115.	NA	M	M	M	M	M	NA	NA	NA	NA	NA	NA	NA
226	Flange ring FF 130.	NA	M	M	M	M	M	NA	NA	NA	NA	NA	NA	NA
227	Flange ring FT 130.	NA	M	M	M	M	M	NA	NA	NA	NA	NA	NA	NA
229	Flange FT 130.	NA	NA	NA	NA	M	M	NA	NA	NA	NA	NA	NA	NA

¹⁾ Certain variant codes cannot be used simultaneously.

S = Included as standard

P = New manufacture only

M = On modification of a stocked motor; or on new manufacture, the number of number per order may be limited.

R = On request

NA = Not applicable.

Code ¹⁾	Variant	Frame size													
		63	71	80	90	100	112	132	160	180	200	225	250	280	
233	Flange ring FF 165.	NA	M	M	M	M	M	NA	NA	NA	NA	NA	NA	NA	
234	Flange ring FT 165.	NA	M	M	M	M	M	NA	NA	NA	NA	NA	NA	NA	
235	Flange FF 165.	NA	NA	NA	M	NA	NA	NA	NA	NA	NA	NA	NA	NA	
243	Flange ring FF 215.	NA	NA	NA	NA	M	M	M	NA	NA	NA	NA	NA	NA	
244	Flange ring FT 215.	NA	NA	NA	NA	M	M	M	NA	NA	NA	NA	NA	NA	
245	Flange FF 215.	NA	NA	NA	NA	M	M	NA	NA	NA	NA	NA	NA	NA	
255	Flange FF 265.	NA	NA	NA	NA	NA	NA	M	NA	NA	NA	NA	NA	NA	
260	Flange FT 115.	NA	NA	NA	M	NA	NA	NA	NA	NA	NA	NA	NA	NA	
306	IM 1001 foot mounted, from IM 3601 (B3 from B14).	M	M	M	M	M	M	M	NA	NA	NA	NA	NA	NA	
307	IM 2101 foot/flange mounted, IEC flange, from IM 3601 (B34 from B14).	M	M	M	M	M	M	M	NA	NA	NA	NA	NA	NA	
308	IM 2001 foot/flange mounted, IEC flange, from IM 3601 (B35 from B14).	M	M	M	M	M	M	M	NA	NA	NA	NA	NA	NA	
309	IM 1001 foot mounted, from IM 3001 (B3 from B5).	M	M	M	M	M	M	M	NA	NA	NA	NA	NA	NA	
310	IM 2101 foot/flange mounted, IEC flange, from IM 3001 (B34 from B5).	M	M	M	M	M	M	M	NA	NA	NA	NA	NA	NA	
311	IM 2001 foot/flange mounted, IEC flange, from IM 3001 (B35 from B5).	M	M	M	M	M	M	M	NA	NA	NA	NA	NA	NA	
312	IM 1001 foot mounted, from IM 2101 (B3 from B34).	M	M	M	M	M	M	M	NA	NA	NA	NA	NA	NA	
315	IM 2001 foot/flange mounted, IEC flange, from IM 2101 (B35 from B34).	M	M	M	M	M	M	M	NA	NA	NA	NA	NA	NA	
316	IM 1001 foot mounted, from IM 2001 (B3 from B35).	M	M	M	M	M	M	M	NA	NA	NA	NA	NA	NA	
319	IM 2101 foot/flange mounted, IEC flange, from IM 2001 (B34 from B35).	M	M	M	M	M	M	M	NA	NA	NA	NA	NA	NA	

Painting

114	Special paint colour, standard grade.	M	P	P	M	M	M	M	M	M	M	M	M	M
168	Primer paint only.	NA	NA	NA	P	P	P	P	NA	NA	NA	NA	NA	NA

Protection

005	Metal protective roof, vertical motor, shaft down.	M	M	M	M	M	M	M	M	M	M	M	M	M
072	Radial seal at D-end.	M	M	M	M	M	M	M	M	M	M	M	M	M
073	Sealed against oil at D-end.	NA	NA	NA	NA	NA	NA	NA	NA	NA	NA	NA	M	NA
158	Degree of protection IP65.	M	M	M	M	M	M	M	M	M	M	M	M	M
211	Weather protected, IP xx W	NA	NA	NA	P	P	P	M	M	M	M	M	M	M
403	Degree of protection IP56.	M	M	M	M	M	M	M	M	M	M	M	M	M
404	Degree of protection IP56, without fan and fan cover.	NA	NA	NA	P	P	P	P	NA	NA	NA	NA	NA	NA
784	Gamma-seal at D-end.	NA	NA	NA	M	M	M	M	M	M	M	M	M	M

Rating & instruction plates

002	Restamping voltage, frequency and output, continuous duty.	M	M	M	M	M	M	M	M	M	M	M	M	M
003	Individual serial number.	M	M	M	M	M	M	M	M	M	M	M	M	M
004	Additional text on std rating plate (max 12 digits on free text line).	NA	NA	NA	M	M	M	M	M	M	M	M	M	M
095	Restamping output (maintained voltage, frequency), intermittent duty.	M	M	M	M	M	M	M	M	M	M	M	M	M
098	Stainless rating plate.	M	M	M	M	M	M	M	M	M	M	M	M	M
135	Mounting of additional identification plate, stainless.	M	M	M	M	M	M	M	R	R	R	R	R	R

¹⁾ Certain variant codes cannot be used simultaneously.

S = Included as standard

P = New manufacture only

M = On modification of a stocked motor; or on new manufacture, the number of number per order may be limited.

R = On request

NA = Not applicable.

Code ¹⁾	Variant	Frame size												
		63	71	80	90	100	112	132	160	180	200	225	250	280
138	Mounting of additional identification plate, aluminium.	M	M	M	M	M	M	M	M	M	M	M	M	M
139	Additional identification plate delivered loose.	M	M	M	M	M	M	M	M	M	M	M	M	M
160	Additional rating plate affixed.	P	P	P	M	M	M	M	M	M	M	M	M	M
161	Additional rating plate delivered loose.	M	M	M	M	M	M	M	M	M	M	M	M	M
162	Rating plate fixed to stator.	S	S	S	S	S	S	NA	S	S	S	S	S	S
163	Frequency converter rating plate. Rating data according to quotation.	R	R	R	R	R	R	R	M	M	M	M	M	M
198	Aluminum rating plate.	S	S	S	S	S	S	M	S	S	S	S	S	S
Shaft & rotor														
069	Two shaft extensions as per basic catalogue.	NA	NA	NA	P	P	P	P	P	P	P	P	P	P
070	One or two special shaft extensions, standard shaft material.	NA	NA	NA	P	P	P	P	R	R	R	R	R	R
131	Motor delivered with half key (Key not exceeding shaft diameter)	NA	NA	NA	M	M	M	M	M	M	M	M	M	M
164	Shaft extension with closed key-way.	NA	NA	NA	NA	NA	NA	NA	S	S	S	S	S	S
165	Shaft extension with open key-way.	NA	NA	NA	P	P	P	P	P	P	P	P	P	P
410	Stainless steel shaft (standard or non-standard design).	NA	NA	NA	P	P	P	P	R	R	R	R	R	R
Standards and Regulations														
010	Fulfilling CSA Safety Certificate.	NA	NA	NA	P	P	P	NA	M	M	M	M	M	M
011	Fulfilling CSA Energy Efficiency Verification (code 010 included).	NA	NA	NA	NA	NA	NA	NA	M	M	M	M	M	M
778	GOST Export/Import Certificate (Russia).	NA	NA	NA	M	M	M	M	M	M	M	M	M	M
779	SASO Export/Import Certificate (Saudi Arabia)	NA	NA	NA	NA	NA	NA	NA	M	M	M	M	M	M
Stator winding temperature sensors														
121	Bimetal detectors, break type (NCC), (3 in series), 130°C, in stator winding.	M	M	M	M	M	M	M	M	M	M	M	M	M
122	Bimetal detectors, break type (NCC), (3 in series), 150°C, in stator winding.	M	M	M	M	M	M	M	M	M	M	M	M	M
123	Bimetal detectors, break type (NCC), (3 in series), 170°C, in stator winding.	M	M	M	M	M	M	M	M	M	M	M	M	M
124	Bimetal detectors, break type (NCC), (3 in series), 140°C, in stator winding.	NA	NA	NA	NA	NA	NA	NA	M	M	M	M	M	M
125	Bimetal detectors, break type (NCC), (2x3 in series), 150°C, in stator winding.	NA	NA	NA	M	M	M	M	M	M	M	M	M	M
127	Bimetal detectors, break type (NCC), (3 in series, 130°C & 3 in series, 150°C), in stator winding.	NA	NA	NA	M	M	M	M	M	M	M	M	M	M
321	Bimetal detectors, closing type (NO), (3 in parallel), 130°C, in stator winding.	M	M	M	M	M	M	M	R	R	R	R	R	R
322	Bimetal detectors, closing type (NO), (3 in parallel), 150°C, in stator winding.	M	M	M	M	M	M	M	R	R	R	R	R	R
323	Bimetal detectors, closing type (NO), (3 in parallel), 170°C, in stator winding.	NA	NA	NA	P	P	P	P	R	R	R	R	R	R
325	Bimetal detectors, closing type (NO), (2x3 in parallel), 150°C, in stator winding.	NA	NA	NA	P	P	M	M	R	R	R	R	R	R
327	Bimetal detectors, closing type (NO), (3 in parallel, 130°C & 3 in parallel, 150°C), in stator winding.	NA	NA	NA	P	P	M	M	R	R	R	R	R	R
435	PTC - thermistors (3 in series), 130°C, in stator winding.	M	M	M	M	M	M	M	M	M	M	M	M	M

¹⁾ Certain variant codes cannot be used simultaneously.

S = Included as standard
P = New manufacture only
M = On modification of a stocked motor; or on new manufacture, the number of number per order may be limited.
R = On request
NA = Not applicable.

Code ¹⁾	Variant	Frame size												
		63	71	80	90	100	112	132	160	180	200	225	250	280
436	PTC - thermistors (3 in series), 150°C, in stator winding.	M	M	M	M	M	M	M	NA	NA	S	S	S	S
437	PTC - thermistors (3 in series), 170°C, in stator winding.	M	M	M	P	P	M	M	M	M	M	M	M	M
439	PTC - thermistors (2x3 in series), 150°C, in stator winding.	NA	NA	NA	M	M	M	M	M	M	M	M	M	M
440	PTC - thermistors (3 in series, 110°C & 3 in series, 130°C), in stator winding.	NA	NA	NA	P	P	P	P	R	R	R	R	R	R
441	PTC - thermistors (3 in series, 130°C & 3 in series, 150°C), in stator winding.	NA	NA	NA	M	M	M	M	M	M	M	M	M	M
442	PTC - thermistors (3 in series, 150°C & 3 in series, 170°C), in stator winding.	NA	NA	NA	P	P	M	M	M	M	M	M	M	M
445	Pt-100 2-wire in stator winding, 1 per phase	NA	NA	NA	R	R	M	M	M	M	M	M	M	M
446	Pt-100 2-wire in stator winding, 2 per phase	NA	NA	NA	R	R	R	R	M	M	M	M	M	M
Terminal box														
015	Motor supplied in D connection.	M	M	M	M	M	M	M	M	M	M	M	M	M
016	9 terminals in terminal box	NA	NA	NA	P	P	P	P	NA	NA	NA	NA	NA	NA
017	Motor supplied in Y connection.	M	M	M	P	P	NA	NA	M	M	M	M	M	M
019	Larger than standard terminal box.	NA	NA	NA	NA	NA	NA	NA	M	M	M	M	M	NA
021	Terminal box LHS (seen from D-end).	NA	NA	NA	NA	NA	NA	NA	NA	NA	P	P	P	P
022	Cable entry LHS (seen from D-end).	NA	NA	NA	NA	NA	NA	NA	S	S	R	R	R	R
136	Extended cable connection, standard terminal box.	NA	NA	NA	P	P	P	P	R	R	R	R	R	R
137	Extended cable connection, low terminal box, "Flying leads".	P	P	P	P	P	P	P	R	R	R	R	R	R
180	Terminal box RHS (seen from D-end).	NA	NA	NA	NA	NA	NA	NA	M	M	M	M	M	P
230	Standard metal cable glands.	M	M	M	M	M	M	M	M	M	M	M	M	M
375	Standard plastic cable gland	M	M	M	M	M	M	M	NA	NA	NA	NA	NA	NA
376	Two standard plastic cable glands	M	M	M	M	M	M	M	NA	NA	NA	NA	NA	NA
400	4 x 90 degr turnable terminal box.	NA	NA	NA	NA	NA	NA	NA	R	R	NA	NA	NA	NA
402	Terminal box adapted for AI cables.	NA	NA	NA	NA	NA	NA	NA	NA	NA	P	P	P	P
418	Separate terminal box for auxiliaries, standard material.	NA	NA	NA	NA	R	R	R	M	M	M	M	M	M
465	Terminal box on top.	NA	NA	NA	NA	NA	NA	NA	S	S	S	S	S	S
467	Lower than standard terminal box and rubber extended cable. Cable length 2m.	NA	NA	NA	NA	NA	NA	NA	P	P	P	P	P	P
729	Aluminum non-drilled flange for cable glands	NA	NA	NA	NA	NA	NA	NA	NA	NA	M	M	M	M
731	Two standard metal cable glands.	M	M	M	M	M	M	M	M	M	M	M	M	M
738	Prepared for metric cable glands.	NA	NA	NA	NA	NA	NA	NA	S	S	S	S	S	S
739	Prepared for metric cable glands according to DIN 42925, draft aug. 1999.	NA	NA	NA	NA	NA	NA	NA	S	S	M	M	M	P
740	Prepared for PG cable glands.	NA	NA	NA	NA	NA	NA	NA	M	M	M	M	M	M
Testing														
140	Test confirmation.	M	M	M	M	M	M	M	M	M	M	M	M	M
145	Type test report from a catalogue motor, 400V 50Hz.	M	M	M	M	M	M	M	M	M	M	M	M	M
146	Type test with report for one motor from specific delivery batch.	M	M	M	M	M	M	M	M	M	M	M	M	M
147	Type test with report for motor from specific delivery batch, customer witnessed.	M	M	M	M	M	M	M	M	M	M	M	M	M
148	Routine test report.	M	M	M	M	M	M	M	M	M	M	M	M	M
153	Reduced test for classification society.	M	M	M	M	M	M	M	M	M	M	M	M	M

¹⁾ Certain variant codes cannot be used simultaneously.

S = Included as standard
P = New manufacture only
M = On modification of a stocked motor; or on new manufacture, the number of number per order may be limited.
R = On request
NA = Not applicable.

Code ¹⁾	Variant	Frame size												
		63	71	80	90	100	112	132	160	180	200	225	250	280
221	Type test and multi-point load test with report for one motor from specific delivery batch.	M	M	M	M	M	M	M	M	M	M	M	M	M
222	Torque/speed curve, type test and multi-point load test with report for one motor from specific delivery batch.	NA	NA	NA	P	P	P	P	M	M	M	M	M	M
760	Vibration level test	M	M	M	P	P	P	P	M	M	M	M	M	M
762	Noise level test for one motor from specific delivery batch.	M	M	M	P	P	P	P	M	M	M	M	M	M
763	Noise spectrum test for one motor from specific delivery batch.	NA	NA	NA	P	P	NA	NA	R	R	R	R	R	R
Variable speed drives														
470	Prepared for hollow shaft pulse tacho (L&L equivalent).	R	R	R	R	R	R	R	M	M	M	M	M	M
472	1024 pulse tacho (L&L 861007455-1024).	R	R	R	R	R	R	P	M	M	M	M	M	M
473	2048 pulse tacho (L&L 861007455-2048).	R	R	R	R	R	R	R	M	M	M	M	M	M
474	Separate motor cooling (fan axial, N-end) and prepared for hollow shaft tacho (L&L equivalent).	R	R	R	R	R	R	R	M	M	M	M	M	M
476	Separate motor cooling (fan axial, N-end) and 1024 pulse tacho (L&L 861007455-1024).	R	R	R	R	R	R	P	M	M	M	M	M	M
477	Separate motor cooling (fan axial, N-end) and 2048 pulse tacho (L&L 861007455-2048).	R	R	R	R	R	R	R	M	M	M	M	M	M
570	Prepared for hollow shaft pulse tacho (L&L 503).	R	R	R	NA	NA	R	R	M	M	M	M	M	M
572	1024 pulse tacho (L&L 503).	R	R	R	NA	NA	NA	NA	M	M	M	M	M	M
573	2048 pulse tacho (L&L 503).	R	R	R	NA	NA	NA	NA	M	M	M	M	M	M
574	Separate motor cooling (fan axial, N-end) and prepared for hollow shaft tacho (L&L 503).	R	R	R	NA	NA	NA	NA	M	M	M	M	M	M
576	Separate motor cooling (fan axial, N-end) and 1024 pulse tacho (L&L 503).	R	R	R	NA	NA	NA	NA	M	M	M	M	M	M
577	Separate motor cooling (fan axial, N-end) and 2048 pulse tacho (L&L 503).	R	R	R	NA	NA	NA	NA	M	M	M	M	M	M
578	Separate motor cooling, IP44, 400V, 50Hz (fan axial, N-end) and prepared for hollow shaft tacho (L&L 503).	NA	NA	NA	NA	NA	NA	NA	M	M	M	M	M	M
580	Separate motor cooling, IP44, 400V, 50Hz (fan axial, N-end) and 1024 pulse tacho (L&L 503).	NA	NA	NA	NA	NA	NA	NA	M	M	M	M	M	M
581	Separate motor cooling, IP44, 400V, 50Hz (fan axial, N-end) and 2048 pulse tacho (L&L 503).	NA	NA	NA	NA	NA	R	R	M	M	M	M	M	M
661	1024 Pulse tacho mounted, Hohner series 59, 11-30V	NA	R	R	P	P	P	P	NA	NA	NA	NA	NA	NA
662	2048 Pulse tacho mounted, Hohner series 59, 11-30V	NA	R	R	P	P	P	P	NA	NA	NA	NA	NA	NA
704	EMC cable gland.	NA	NA	NA	M	M	M	M	M	M	M	M	M	M
Y/Δ starting														
117	Terminals for Y/Δ start at both speeds (two speed windings).	NA	NA	NA	P	P	P	P	NA	NA	NA	NA	NA	NA
118	Terminals for Y/Δ start at high speed (two speed windings).	P	P	P	P	P	P	P	NA	NA	NA	NA	NA	NA

¹⁾ Certain variant codes cannot be used simultaneously.

S = Included as standard

P = New manufacture only

M = On modification of a stocked motor; or on new manufacture, the number of number per order may be limited.

R = On request

NA = Not applicable.

DIP motors, cast iron frame, 3 D Dimension drawings

Foot-mounted motor IM 1001, IM B3

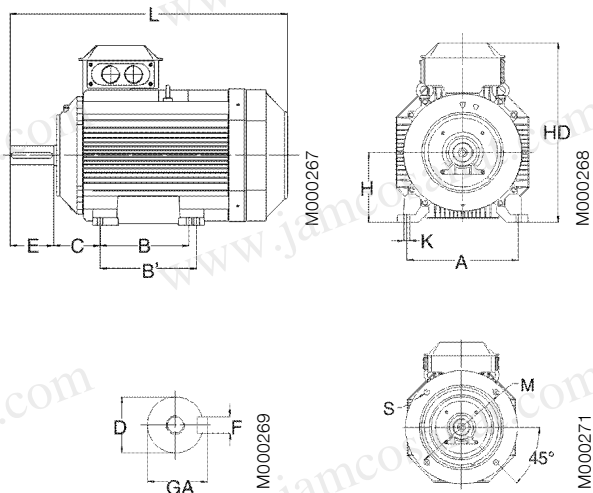

Sizes 71-200

Flange-mounted motor IM 3001, IM B5

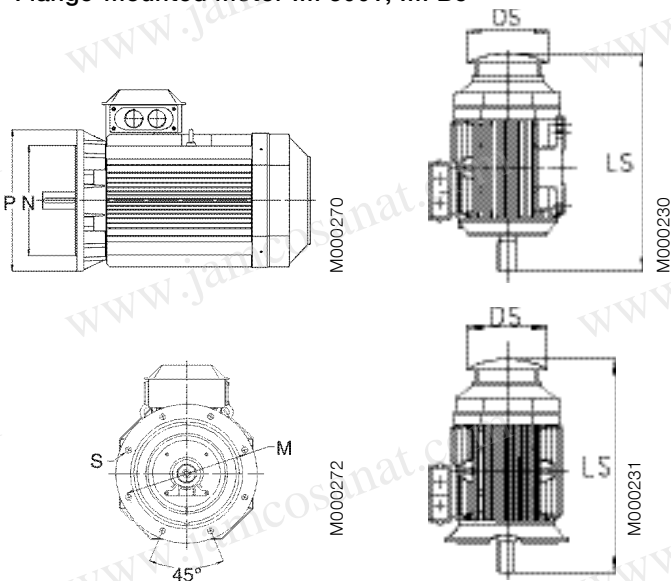

Sizes 225-355

Protective roof,
variant code 005

Motor size	IM 1001, IM B3 AND IM 3001, IM B5										IM 1001, IM B3					IM 3001, IM B5					Protective roof					
	D		GA		F		E		L max		O ⁹⁾	A	B	B'	C	HD	K	H	M	N	P	S	DS	LS		
	poles	poles	poles	poles	poles	poles	poles	poles	poles	poles														poles	poles	
	2	4-8	2	4-8	2	4-8	2	4-8	2	4-8	2	4-8	2	4-8	2	4-8	2	4-8	2	4-8	2	4-8	2	4-8	2	4-8
80	19	19	21,5	21,5	6	6	40	40	285	285	20	125	100	135	50	230	10	80	165	130	200	12				
90 S	24	24	27	27	8	8	50	50	310	310	20	140	100	140	56	250	10	90	165	130	200	12				
90 L	24	24	27	27	8	8	50	50	335	335	20	140	125	165	56	250	10	90	165	130	200	12				
100	28	28	31	31	8	8	60	60	380	380	25	160	140	180	63	285	12	100	215	180	250	14.5				
112	28	28	31	31	8	8	60	60	395	395	25	190	140	190	70	310	12	112	215	180	250	14.5				
132 S	38	38	41	41	10	10	80	80	465	465	30	216	140	205	89	350	12	132	265	230	300	14.5				
132 M	38	38	41	41	10	10	80	80	505	505	30	216	170	240	89	350	12	132	265	230	300	14.5				
160	42	42	45	45	12	12	110	110	808	808	45	254	210	254	108	499	14.5	160	300	250	350	18.5	328	756	756	
180	48	48	51.5	51.5	14	14	110	110	826	826	50	279	241	279	121	539	14.5	180	300	250	350	18.5	359	756	756	
200	55	55	59	59	16	16	110	110	774	774	70	318	267	305	133	536	18.5	200	350	300	400	18.5	414	844	844	
225	55	60	59	64	16	18	110	140	841	871	80	356	286	311	149	583	18.5	225	400	350	450	18.5	462	921	951	
250	60	65	64	69	18	18	140	140	875	875	90	406	311	349	168	646	24	250	500	450	550	18.5	506	965	965	
280	65	75	69	79.5	18	20	140	140	1088	1088	100	457	368	419	190	759	24	280	500	450	550	18	555	1190	1190	
315 SM_	65	80	69	85	18	22	140	170	1174	1204	115	508	406	457	216	852	30	315	600	550	660	23	624	1290	1320	
315 ML_	65	90	69	95	18	25	140	170	1285	1315	115	508	457	508	216	852	30	315	600	550	660	23	624	1401	1431	
355 SM_	70	100	62.5	90	20	28	140	210	1409	1479	130	610	500	560	254	958	35	355	740	680	800	23	720	1476	1546	
355 ML_	70	100	62.5	90	20	28	140	210	1514	1584	130	610	560	630	254	958	35	355	740	680	800	23	720	1528	1703	
355 LK_	70	100	62.5	90	20	28	140	210	1764	1834	130	610	710	900	254	958	35	355	740	680	800	23	720	1633	1703	
400 L_	80	110	85	126	22	28	170	210	1851	1891	150	710	900	1000	224	1045	35	400	940	880	1000	28	810	1860	1900	
400 LK_	80	100	85	106	22	28	170	210	1851	1891	150	686	710	800	280	1045	35	400	740	680	800	24	810	1860	1900	

⁹⁾ 0 = Minimum free free distance for cooling

IM 3601, IM B14

Motor size	Flange size	Flange dimensions				
		P	M	N	S	T
71	C105	105	85	70	M6	2.5
71	C140	140	115	95	M8	3
80	C120	120	100	80	M6	3
80	C160	160	130	110	M8	3.5
90	C140	140	115	95	M8	3
90	C160	160	130	110	M8	3.5
100,112	C160	160	130	110	M8	3.5
100,112	C200	200	165	130	M10	3.5

Tolerances:

- A, B ± 0,8
- D, DA ISO k6 < Ø 50mm
- ISO m6 > Ø 50mm
- F, FA ISO h9
- H -0.5
- N ISO j6
- C, CA ± 0.8

Above table gives the main dimensions in mm. For detailed drawings please see our web-pages www.abb.com/motors&generators or contact ABB.

DIP motors, aluminum frame, 2 D, 3 D

Dimension drawings

Foot-mounted motor IM 1001, IM B3

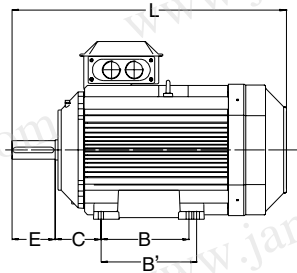

M000267

Shaft extension

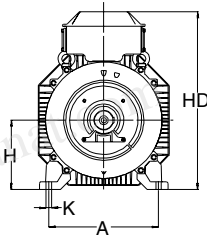

M000268

Flange-mounted motor IM 3001, IM B5

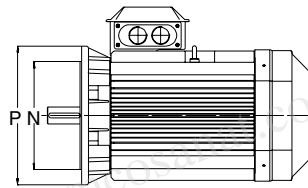

M000270

Flanges

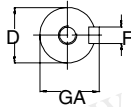

M000269

Sizes 90-200

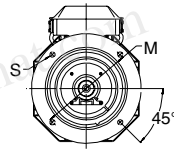

M000271

Sizes 225-280

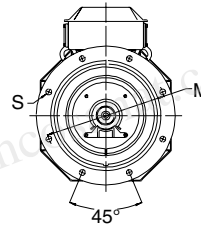

M000272

Motor size	IM 1001. IM B3 AND IM 3001. IM B5											IM 1001. IM B3				IM 3001. IM B5						
	D poles		GA poles		F poles		E poles		L max poles		O ⁵⁾	A	B	B'	C	HD	K	H	M	N	P	S
	2	4-8	2	4-8	2	4-8	2	4-8	2	4-8												
M3AAD 63	11	11	12.5	12.5	4	4	23	23	214	214	20	100	80	-	40	151	7	63	100	80	120	7
M3AAD 71	14	14	16	16	5	5	30	30	240	240	20	112	90	-	45	180	7	71	130	110	160	10
80	19	19	21.5	21.5	6	6	40	40	265.5	265.5	25	125	100	-	50	193.5	10	80	165	130	200	12
90 S	24	24	27	27	8	8	50	50	284.5	284.5	30	140	100	-	56	217	10	90	165	130	200	12
90 L	24	24	27	27	8	8	50	50	309.5	309.5	30	140	125	-	56	217	10	90	165	130	200	12
90 LD	24	24	27	27	8	8	50	50	331.5	331.5	30	140	125	-	56	217	10	90	165	130	200	12
M3AAD 100	28	28	31	31	8	8	60	60	351	351	35	160	140	-	63	237	12	100	215	180	250	15
112	28	28	31	31	8	8	60	60	393	393	35	190	140	-	70	249	12	112	215	180	250	15
132¹⁾	38	38	41	41	10	10	80	80	447	447	50	216	140	178	89	295.5	12	132	265	230	300	14.5
132²⁾	38	38	41	41	10	10	80	80	550	550	50	216	140	178	89	321	12	132	265	230	300	14.5
M3AA 160³⁾	42	42	45	45	12	12	110	110	584	584	50	254	210	254	108	370	15	160	300	250	350	19
160⁴⁾	42	42	45	45	12	12	110	110	681	681	50	254	210	254	108	370	15	160	300	250	350	19
180	48	48	51.5	51.5	14	14	110	110	726	726	55	279	241	279	121	405	15	180	300	250	350	19
200	55	55	59	59	16	16	110	110	821	821	55	318	267	305	133	532	18	200	350	300	400	19
225	55	60	59	64	16	18	110	140	850	880	60	356	286	311	149	579	18	225	400	350	450	19
250	60	65	64	69	18	18	140	140	884	884	65	406	311	349	168	627	22	250	500	450	550	19
280	65	75	69	79.5	18	20	140	140	884	884	65	457	368	419	190	627	24	280	500	450	550	19

¹⁾ All types except 2).

²⁾ SM_.

³⁾ MLA-2 and MLB-2; MLA-4 poles; MLA-6 poles; MLA-8 and MLB-8 poles.

⁴⁾ Remaining variants, i.e. MLC-2, MLD-2 and MLE-2 poles; MLB-4, MLC-4 and MLD-4 poles; MLC-8 poles.

⁵⁾ 0 = Minimum free distance for cooling

IM 3601, IM B14

Motor size	LA	M	N	P	S	T
63	10	65	50	80	M5	2.5
71	11	85	70	105	M6	3
80	11	100	80	120	M6	3
90	13	115	95	140	M8	3
100	14	130	110	160	M8	3.5
112	14	130	110	160	M8	3.5
132	18	165	165	200	M10	3.5

Tolerances:

A, B	± 0,8
D, DA	ISO k6 < Ø 50mm ISO m6 > Ø 50mm
F, FA	ISO h9
H	-0.5
N	ISO j6
C, CA	± 0.8

Above table gives the main dimensions in mm. For detailed drawings please see our web-pages www.abb.com/motors&generators or contact ABB.

Dust ignition proof motor construction

Typical exploded view of cast iron motors, frame size 315

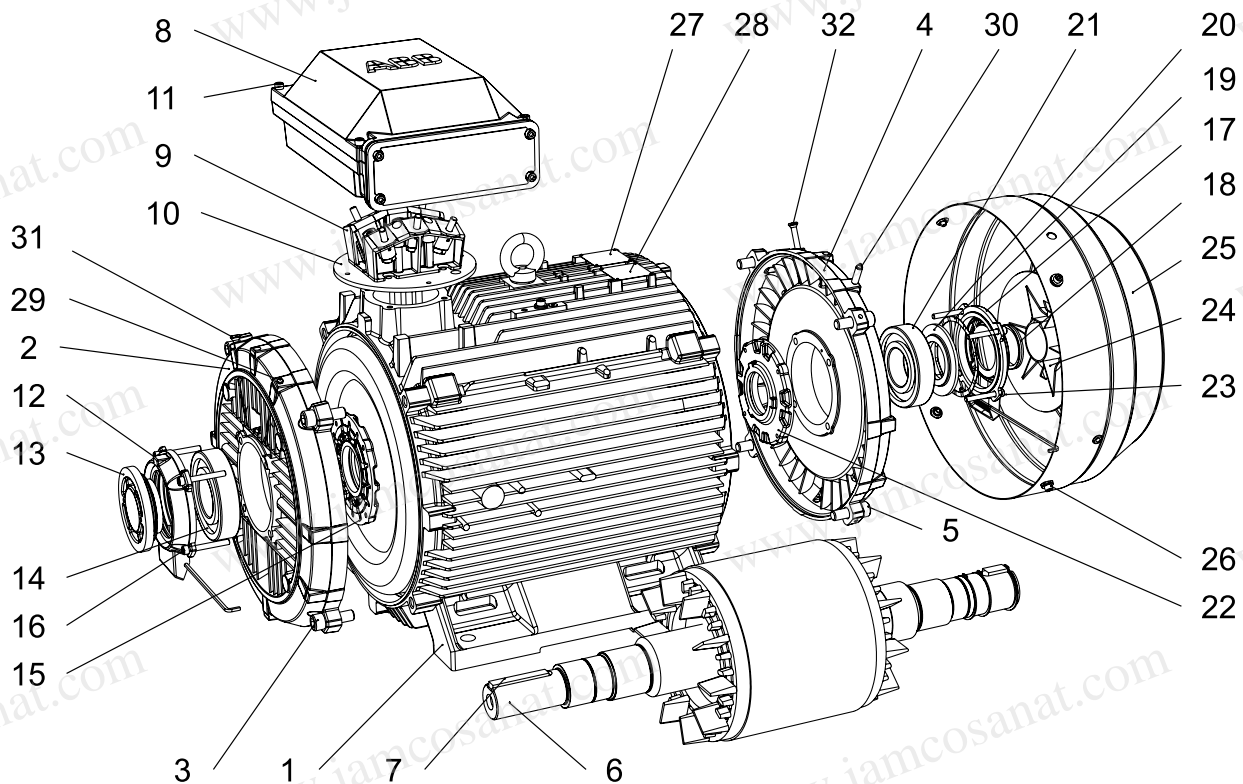

- | | | | |
|----|--|----|---------------------------------|
| 1 | Stator frame | 17 | Outer bearing cover, N-end |
| 2 | Endshield, D-end | 18 | Seal, N-end |
| 3 | Screws for endshield, D-end | 19 | Wave spring |
| 4 | Endshield, N-end | 20 | Valve disc, N-end |
| 5 | Screws for endshield, N-end | 21 | Bearing, N-end |
| 6 | Rotor with shaft | 22 | Inner bearing cover, N-end |
| 7 | Key, D-end | 23 | Screws for bearing cover, N-end |
| 8 | Terminal box | 24 | Fan |
| 9 | Terminal board | 25 | Fan cover |
| 10 | Intermediate flange | 26 | Screws for fan cover |
| 11 | Screws for terminal box cover | 27 | Rating plate |
| 12 | Outer bearing cover, D-end | 28 | Regreasing plate |
| 13 | Valve disc with labyrinth seal, D-end;
standard in 2-pole motors (V-ring in 4-8 pole) | 29 | Grease nipple, D-end |
| 14 | Bearing, D-end | 30 | Grease nipple, N-end |
| 15 | Inner bearing cover, D-end | 31 | SPM nipple, D-end |
| 16 | Screws for bearing cover, D-end | 32 | SPM nipple, N-end |

M000220

Certificate examples

IECEx Certificate of Conformity

INTERNATIONAL ELECTROTECHNICAL COMMISSION
IEC Certification Scheme for Explosive Atmospheres
for rules and details of the IECEx Scheme visit www.iecex.com

Certificate No.: IECEx LC1 07 0201 Issue No.: History:

Status: **Current**

Date of Issue: 2007-01-12 Page 1 of 3

Applicant: **ABB Oy, Motors**
Strombergin Puistotie 5A
P.O. Box 633
FI-65101 VAASA
Finland

Electrical Apparatus: **M3GP90-450 & M3LP400-450 series, 13 cage induction motor types**
Optional accessory:

Type of Protection: **Non sparking Ex nA and dust protection Ex ID.**

Marking: **Ex nA II T3, Ex ID A21 A22 T12S**

Approved for issue on behalf of the IECEx
Certification Body: **Marc GILLAUX**
Ex Certification Manager

Signature: *(Signature)*
(or printed version)

Date: **12 JAN. 2007**

1 This certificate and schedule may only be reproduced in full.
2 This certificate is not transferable and remains the property of the issuing body.
3 The Status and authenticity of this certificate may be verified by visiting the Official IECEx Website.

Certificate issued by:
Laboratoire Central des Industries Electriques (LCIE)
33 Avenue du General Leclerc
FR-92260 Fontenay-aux-Roses
France

M000730

LCIE

Team ATEX Ex

1 ATTESTATION D'EXAMEN DE TYPE VOLONTAIRE

2 Appareil destiné à être utilisé en atmosphères explosibles (Directive 94/9/CE)

3 Numéro de l'attestation d'examen de type LCIE 09 ATEX 1010

4 Appareil
Moteur asynchrone
Type : M3GP180 ..., M3GP180 ... (Génération H)

5 Demandeur : **ABB Oy Motors**
Adresse : **Strombergin Puistotie 5A
FIN - 65101 VAASA - Finland**

7 Cet appareil ou système de protection et ses variantes éventuelles acceptées sont décrits dans l'annexe de la présente attestation et dans les documents descriptifs cités en référence.

8 Le LCIE certifie que cet appareil ou système de protection est conforme aux exigences essentielles de sécurité et de santé pour la conception d'appareils ou système de protection, électriques de catégorie 3 ou non électriques de catégorie 2 et 3, destinés à être utilisés en atmosphères explosibles, données dans l'annexe II de la directive 94/9/CE du Parlement européen et du Conseil du 23 mars 1994.

9 Les résultats des vérifications et essais figurent dans le rapport confidentiel N° 90248-581521.

10 Le respect des exigences essentielles de sécurité et de santé est assuré par la conformité à :
- EN 60079-0 (2006) - EN 61241-0 (2006)
- EN 60079-15 (2005) - EN 61241-1 (2004)

11 Le signe X lorsqu'il est placé à la suite du numéro de l'attestation, indique que cet appareil ou système de protection est soumis aux conditions spéciales pour une utilisation sûre, mentionnées dans l'annexe de la présente attestation.

12 Cette attestation d'examen de type concerne uniquement la conception, les vérifications et essais de l'appareil ou du système de protection spécifiés, conformément à la directive 94/9/CE. Des exigences supplémentaires de la directive sont applicables pour la fabrication et la fourniture de l'appareil ou du système de protection. Ces dernières ne sont pas couvertes par la présente attestation.

13 Le marquage de l'appareil ou du système de protection doit comporter les informations détaillées au point 15.

Fontenay-aux-Roses, le 16 mars 2009

Le responsable de certification ATEX
ATEX certification manager
Marc Gilliaux

Seul le texte en français peut engager la responsabilité du LCIE. Ce document ne peut être reproduit que dans son intégralité, sans aucune modification.
The LCIE's liability applies only on the French text. This document may only be reproduced in its entirety and without any change.

M000740

ABB

EC Declaration of Conformity

The Manufacturer: **ABB Oy Motors**
P.O. Box 633
Strombergin puistotie 5A
FIN - 65101 Vaasa, Finland

hereby declares that

the products: **3-phase induction motors, series M2GP, M3JP, M3JC, M3KP, M3KC, M3GP, M3HP and M3LP, as listed on page 2 in this document, fulfil provisions of the relevant Council Directives:**

Directive 94/9/EC (ATEX of 23rd March 1994)
by applying the following harmonized standards:
EN 60079-0 (2006), EN 60079-1 (2007), EN 60079-7 (2007), EN 60079-15 (2005), EN 61241-0 (2006), EN 61241-1 (2004).

ABB Oy Motors declare on it's sole responsibility,
- that the state of the art of these standards do not modify the result of the assessment carried out by LCIE which issued the EC type examination certificates according to former editions of the standard series.
- that listed motors conform to the requirements of annex II of the directive 94/9/EC clause 1.2.7 by applying the standards serie EN 60034.

Directive 2005/32/EC (EuP of 6th July 2005)
by fulfilling the requirements of the standard EN 60034-30 (March 2009) in respect of the efficiency class.

Note: When installing motors for converter supply applications additional requirements must be respected regarding the motor as well as the installation, as described in the appropriate dedicated addendum.

Signed by: *(Signature)*
Title: **Jouni Ikaheimo**
Product Development Manager

Date: **April 29th, 2010** 3GZF500930-988

ABB Oy

Motors: **ABB Oy**
Postal address: **Strombergin Puistotie 5 A**
P.O. Box 633
FI-65101 Vaasa
FINLAND

Visiting Address: **Strombergin Puistotie 5 A**
P.O. Box 633
FI-65101 Vaasa
FINLAND

Telephone: **+358 10 22 11**
Telefax: **+358 10 22 47372**

Internet: **www.abb.fi**
e-mail: **first.name.last.name@fi.abb.com**

Business Identity Code: **0763403-0**
Domicile: **Helsinki**

M000725-1

ABB

2(2)
2010-04-29

Certificates: **3-phase induction motors, series M2GP, M3JP, M3KP, M3GP, M3HP, M3LP**

Group & category, temperature class, protection	Motor type, IEC frame size	Certification number	Year of CE-marking
Flameproof II 2 G Ex e II B / I C T1-T6 II 2 G Ex e II B / I C T1-T6 In addition: II 2 D Ex ID A21 / IP 65 or II 3 D Ex ID A22 / IP 55, IP65 (3D not for M3JPK160-180 Gen.H)	M3JPM3KP 80	LCIE 04 ATEX 6150	2004
	M3JPM3KP 90	LCIE 04 ATEX 6151	2004
	M3JPM3KP 100-112	LCIE 04 ATEX 6152	2004
	M3JPM3KP 132	LCIE 04 ATEX 6061	2004
	M3JPM3KP 160	LCIE 04 ATEX 6023	2000
	M3JPM3KP 180	LCIE 04 ATEX 6028	2000
	M3JPM3KP 160 Gen.H	LCIE 09 ATEX 3004X	2009
	M3JPM3KP 180 Gen.H	LCIE 09 ATEX 3005X	2009
	M3JPM3KP 200	LCIE 04 ATEX 6027	2000
	M3JPM3KP 225	LCIE 04 ATEX 6029	2000
	M3JPM3KP 250	LCIE 04 ATEX 6030	2000
	M3JPM3KP 280	LCIE 01 ATEX 6078	2001
M3JPM3KP 315	LCIE 01 ATEX 6079	2001	
M3JPM3KP 355	LCIE 03 ATEX 6060	2003	
M3JPM3KP 400	LCIE 04 ATEX 6067	2004	
Increased safety	M3HP 80-90	LCIE 09 ATEX 6047	2006
	M3HP 100-112	LCIE 09 ATEX 6048	2006
	M3HP 132	LCIE 09 ATEX 6049	2006
	M3HP 160	LCIE 01 ATEX 6015	2001
	M3HP 180	LCIE 01 ATEX 6021	2001
	M3HP 160 Gen.H	LCIE 09 ATEX 3022	2009
	M3HP 180 Gen.H	LCIE 09 ATEX 3023	2009
	M3HP 200	LCIE 01 ATEX 6022	2001
	M3HP 225	LCIE 01 ATEX 6023	2001
	M3HP 250	LCIE 01 ATEX 6024	2001
	M3HP 280	LCIE 02 ATEX 6071	2002
	M3HP 315	LCIE 02 ATEX 6072	2002
M3HP 355	LCIE 03 ATEX 6022	2003	
M3HP 400	LCIE 04 ATEX 6013	2004	
Non-sparking II 3D Ex nA II T2-T3	M2GP 71-250	LCIE 05 ATEX 6160	2005
	M2GP 80-400	LCIE 05 ATEX 6089	2006
	M3GP 160 - 180 Gen.H	LCIE 09 ATEX 1010 *	2009
	M3GPM3LP 450	LCIE 06 ATEX 6088	2006
Dust ignition	M3GP 160 - 180 Gen.H	LCIE 09 ATEX 3018	2009
	II 2 D Ex ID A21 IP 65		
Dust ignition	M3GP 160 - 180 Gen.H	LCIE 09 ATEX 1010 *	2009
	II 3 D Ex ID A22	M3GPM3LP 450	LCIE 06 ATEX 6088
Dust ignition	M2GP 71-250	LCIE 05 ATEX 6160	2005
	M3GP 80-400	LCIE 06 ATEX 6089	2006
	II 2 D Ex ID A21 IP 65 or II 3 D Ex ID A22 IP 55, IP65		

1) Notified Body (ExNB): LCIE (0081) - Av. Du Général Leclerc, 33, 92266 Fontenay-aux-Roses, France
2) *) Voluntary Type Examination Certificate for equipment category 3

3GZF500930-988

M000725-2

Dust ignition proof cast iron motors in brief, basic design – 2D

Motor size		80	90	100	112	132	160	180	
Stator	Material	Cast iron, at least EN-GJL-200							
	Paint colour shade	Blue, Munsell 8B 4.5/3.25 / NCS 4822 B05G							
	Corrosion class	C3 medium according to ISO/EN 12944-5							
Bearing end shields	Material	Cast iron, at least EN-GJL-200							
	Paint color shade	Blue, Munsell 8B 4.5/3.25 / NCS 4822 B05G							
	Corrosion class	C3 medium according to ISO/EN 12944-5							
Bearings	D-end	2-pole	6205-2Z/C3	6205-2Z/C3	6206-2Z/C3	6206-2Z/C3	6208-2Z/C3	6309/C3	6310/C3
		4-8 -pole							
	N-end	2-pole	6204-2Z/C3	6205-2Z/C3	6206-2Z/C3	6206-2Z/C3	6208-2Z/C3	6309/C3	6309/C3
		4-8 -pole							
Axially-locked bearings	Inner bearing cover	As standard, locked at D-end							
Bearing seal		Gamma ring							
Lubrication		Permanent grease lubrication.					Regreasable bearings		
SPM-nipples		-					As standard		
Rating plate	Material	Stainless steel							
Terminal box	Frame material	Cast iron, at least EN-GJL-200							
	Cover material	Cast iron, at least EN-GJL-200							
	Screws	Steel 8.8, zinc electroplated and chromated.							
Connections	Cable entries	2xM25x1.5			2xM32x1.5		2xM40x1.5		
	Terminals	6 terminals for connection with cable lugs (not included)							
Fan	Material	Aluminum					Polypropylene. Reinforced with glass fibre.		
Fan cover	Material	Steel					Hot dip galvanized steel		
	Paint colour shade	Blue, Munsell 8B 4.5/3.25 / NCS 4822 B05G							
	Corrosion class	C3 medium according to ISO/EN 12944-5							
Stator winding	Material	Copper							
	Insulation	Insulation class F							
	Winding protection	3 pcs thermistors							
Rotor winding	Material	Pressure die-cast aluminum							
Balancing method		Half key balancing							
Key ways		Open key-way							
Heating elements	On request	25 W							
Drain holes		Optional					As standard, open on delivery		
External earthing bolt		As standard							
Enclosure		IP 55							
Cooling method		IC 411							

Dust ignition proof cast iron motors in brief, basic design – 2D

Motor size		200	225	250	280	315	355	400	450	
Stator	Material	Cast iron, at least EN-GJL-200								
	Paint colour shade	Blue, Munsell 8B 4.5/3.25 / NCS 4822 B05G								
	Corrosion class	C3 medium according to ISO/EN 12944-5								
Bearing end shields	Material	Cast iron, at least EN-GJL-200								
	Paint color shade	Blue, Munsell 8B 4.5/3.25 / NCS 4822 B05G								
	Corrosion class	C3 medium according to ISO/EN 12944-5								
Bearings	D-end	2-pole	6312M/C3	6313M/C3	6315M/C3	6316/C3	6316/C3	6316M/C3	6317/C3	6317/C3
		4-8 -pole	6312/C3	6313/C3	6315/C3	6316/C3	6319/C3	6322/C3	6324/C3	6324/C3
	N-end	2-pole	6310M/C3	6312M/C3	6313M/C3	6316/C3	6319/C3	6316M/C3	6317/C3	6317/C3
		4-8 -pole	6310/C3	6312/C3	6313/C3	6316/C3	6316/C3	6316/C3	6319/C3	6319/C3
Axially-locked bearings	Inner bearing cover	As standard, locked at D-end								
Bearing seal	M3GP	Gamma ring				V-ring				
	M4GP	Gamma ring				Labyrinth seal			NA	
Lubrication		Regreasable bearings				Regreasable bearings				
SPM-nipples		As standard				Optional		As standard		
Rating plate	Material	Stainless steel								
Terminal box	Frame material	Cast iron, at least EN-GJL-200								
	Cover material	Cast iron, at least EN-GJL-200								
	Cover screws material	Steel 8.8, zinc electroplated and chromated.								
Connections	Cable entries	2xM50x1.5				2xM63x1.5		2xØ60/80	2xØ80	2xØ80
								2xØ60	2xØ60/80	2xØ60/80
	Terminals	6 terminals for connection with cable lugs (not included)								
Fan	Material	Aluminum								
Fan cover	Material	Hot dip galvanized steel								
	Paint color shade	Blue, Munsell 8B 4.5/3.25 / NCS 4822 B05G								
	Corrosion class	C3 medium according to ISO/EN 12944-5								
Stator winding	Material	Copper								
	Insulation	Insulation class F								
	Winding protection	3 pcs thermistors								
Rotor winding	Material	Pressure die-cast aluminum								
Balancing method		Half key balancing								
Key ways		Closed key way				Open key way				
Heating elements	Optional	25 W	60 W			120 W				
Drain holes		As standard, open on delivery								
External earthing bolt		As standard								
Enclosure		IP 55								
Cooling method		IC 411								

Dust ignition proof cast iron motors in brief, basic design - 3D

Motor size		80	90	100	112	132	
Stator	Material	Cast iron EN-GJL-200					
	Paint colour shade	Blue, Munsell 8B 4.5/3.25 / NCS 4822 B05G					
	Surface treatment	Two-pack epoxy paint, thickness > 80 µm.					
Bearing end shields	Material	Cast iron EN-GJL-150					
	Paint colour shade	Blue, Munsell 8B 4.5/3.25 / NCS 4822 B05G					
	Surface treatment	Two-pack epoxy paint, thickness > 80 µm.					
Bearings	D-end	2-pole	6204-2Z/C3	6205-2Z/C3	6206-2Z/C3	6206-2Z/C3	6208-2Z/C3
		4-12 -pole					
	N-end	2-pole	6204-2Z/C3	6205-2Z/C3	6206-2Z/C3	6206-2Z/C3	6208-2Z/C3
		4-12 -pole					
Axially locked bearings	Inner bearing cover	On request					
Bearing seal		2RS-integral seals					
Lubrication		Permanent grease lubrication.					
SPM-nipples		-					
Rating plate	Material	Stainless steel 0.80 Cr 18 Ni9					
Terminal box	Frame material	Cast iron EN-GJL-150					
	Cover material	Cast iron EN-GJL-150					
	Screws	Steel 8.8, zinc electroplated and chromated.					
Connections	Cable entries	2xM25x1.5		2xM32x1.5			
	Terminals	6 terminals for connection with cable lugs (not included)					
Fan	Material	Aluminum					
Fan cover	Material	Steel					
	Paint colour shade	Blue, Munsell 8B 4.5/3.25 / NCS 4822 B05G					
	Paint	Two-pack epoxy paint, thickness > 80 µm.					
Stator winding	Material	Copper					
	Insulation	Insulation class F					
	Winding protection	On request					
Rotor winding	Material	Pressure die-cast aluminum					
Balancing method		Half key balancing					
Key ways		Open key way					
Heating elements	Optional	25 W					
Drain holes		Optional					
External earthing bolt		As standard					
Enclosure		IP 55, higher protection on request					
Cooling method		IC 411					

Dust ignition proof cast iron motors in brief, basic design - 3D

Motor size		160	180	200	225	250	280	315	355	400	
Stator	Material	Cast iron EN-GJL-200 / GG 20 / GRS 200									
	Paint colour shade	Blue, Munsell 8B 4.5/3.25 / NCS 4822 B05G									
	Surface treatment	Two-pack epoxy paint, thickness > 80 µm.									
Bearing end shields	Material	Cast iron EN-GJL-200	Cast iron EN-GJL-200 / GG 20 / GRS 200			Cast iron EN-GJL-200/GG20/GRS 200, EN-GJL-250/GG25/GRS 250, EN-GJS-400/GG40/GRS 400					
	Paint colour shade	Blue, Munsell 8B 4.5/3.25 / NCS 4822 B05G									
	Surface treatment	Two-pack epoxy paint, thickness > 80 µm.									
Bearings	D-end	2-pole	6309/C3	6310/C3	6312M/C3	6313M/C3	6315M/C3	6316/C3	6316/C3	6316M/C3	6317/C3
		4-8 pole	6309/C3	6310/C3	6312/C3	6313/C3	6315/C3	6316/C3	6319/C3	6322/C3	6324/C3
	N-end	2-pole	6309/C3	6309/C3	6310M/C3	6312M/C3	6313M/C3	6316/C3	6319/C3	6316M/C3	6317/C3
		4-8 pole	6309/C3	6309/C3	6310/C3	6312/C3	6313/C3	6316/C3	6316/C3	6316/C3	6319/C3
Axially locked bearings	Inner bearing cover	As standard, locked at D-end									
Bearing seal	M3GP	Gamma ring					V-ring				
	M4GP	Gamma ring					Labyrinth seal			NA	
Lubrication		Regreasable bearings as std, lifetime lubrication as option					Regreasable bearings, regreasing nipples, M10x1				
SPM-nipples		As standard					Optional		As standard		
Rating plate	Material	Stainless steel									
Terminal box	Frame material	Cast iron EN-GJL-200	Cast iron EN-GJL-200/GG 20/GRS 200			Cast iron EN-GJL-150 /GG15 / GRS 150					
	Cover material	Cast iron EN-GJL-200	Cast iron EN-GJL-200/GG 20/GRS 200			Cast iron EN-GJL-150 /GG15 / GRS 150					
	Cover screws material	Steel 8.8, zinc electroplated and chromated									
Connections	Cable entries	2xM40x1.5		2xM50x1.5		2xM63x1.5		2xØ60/80	2xØ80		
	Terminals	6 terminals for connection with cable lugs (not included).									
Fan	Material	Aluminum									
Fan cover	Material	Zinc coated steel					Steel				
	Paint colour shade	Blue, Munsell 8B 4.5/3.25 / NCS 4822 B05G									
	Paint	Two-pack polyester paint, thickness > 80 µm					Two-pack epoxy polyester paint, thickness > 80 µm.				
Stator winding	Material	Copper									
	Insulation	Insulation class F									
	Winding protection	3 pcs thermistors									
Rotor winding	Material	Pressure die-cast aluminum					Pressure die-cast aluminum or copper				
Balancing method		Half key balancing									
Key ways		Closed key-way					Open key way				
Heating elements	Optional	25 W			60 W		120 W				
Drain holes		As standard, open on delivery									
External earthing bolt		As standard									
Enclosure		IP 55, higher protection on request									
Cooling method		IC 411									

Dust ignition proof aluminum motors in brief, basic design – 2D

Motor size		90	100	112	132
Stator	Material	Diecast aluminum alloy.			
	Paint colour shade	Munsell blue 8B 4.5/3.25 / NCS 4822-B05G.			
	Surface treatment	Polyester powder paint $\geq 30 \mu\text{m}$.			
Feet		Fixed feet.			
	Material	Aluminum alloy, integrated with stator.			
Bearing end shields	Material	Die-cast aluminum alloy.			
	Paint colour shade	Munsell blue 8B 4.5/3.25 / NCS 4822 B05G.			
	Surface treatment	Polyester powder paint $\geq 30 \mu\text{m}$.			
Bearings	D-end	6205-2RS1/C3	6306-2RS1/C3	6306-2RS1/C3	6208-2RS1/C3
	N-end	6204-2RS1/C3	6205-2RS1/C3	6205-2RS1/C3	6206-2RS1/C3 ¹⁾
					6208-2RS1/C3 ²⁾
		¹⁾ SA 2, SB 2, S 4, M 4, S 6, MA 6, MB 6, S 8, M 8 and two-speed starts with S. ²⁾ All types except ¹⁾			
Axially-locked bearings		D-end with inner bearing cover.			
Bearing seal	D-end	V-ring.			
	N-end	V-rings.			
Lubrication		Permanently lubricated bearings. Grease temperature range -40 to +160°C.			
Terminal box	Material	Die-cast aluminum alloy, base integrated with stator.			
	Surface treatment	Similar to stator.			
	Screws	Steel 8.8, zinc electroplated.			
Connections	Knock-out openings	2 x (M20 + M25)			2 x (M20 + M25)
	Terminal box	Screw terminal. 6 terminals.			Cable lugs. 6 terminals.
	Max Cu-area, mm ²	6			10
Fan	Material	Aluminum fan.			
Fan cover	Material	Steel.			
Stator winding	Material	Copper.			
	Impregnation	Polyester varnish. Tropicalised.			
	Insulation class	Insulation class F.			
	Winding protection	PTC-thermistors, 150°C			
Rotor winding	Material	Die-cast aluminum.			
Balancing method		Half key balancing.			
Key ways		Closed key way.			
Heating elements		25 W			
Drain holes		Not included, drain holes sealed on delivery.			
External earthing bolt		As standard.			
Enclosure		IP 65.			
Cooling method		IC 411.			

Dust ignition proof aluminum motors in brief, basic design – 2D

Motor size		160	180	200	225	250	280	
Stator	Material	Diecast aluminum alloy.		Extruded aluminum alloy.				
	Paint colour shade	Munsell blue 8B 4.5/3.25 / NCS 4822 B05G						
	Surface treatment	Polyester powder paint $\geq 50 \mu\text{m}$.						
Feet	Material	Aluminum alloy, integrated with stator.		Aluminum alloy, bolted to the stator. Frame size 250, 2-pole, cast iron.		Cast iron		
Bearing end shields	Material	Cast iron						
	Paint colour shade	Munsell blue 8B 4.5/3.25 / NCS 4822 B05G						
	Surface treatment	Polyester powder paint $\geq 50 \mu\text{m}$.						
Bearings	D-end	2-pole	6309-2Z/C3	6310-2Z/C3	6312-2Z/C3	6313-2Z/C3	6315-2Z/C3	6315-2Z/C3
		4-8 -pole						
	N-end	2-pole	6209-2Z/C3	6209-2Z/C3	6210-2Z/C3	6212-2Z/C3	6213-2Z/C3	6213-2Z/C3
		4-8 -pole						
Axially-locked bearings	Inner bearing cover	D-end						
Bearing seal	D-end	V-ring.		Outer and inner V-rings.				
	N-end	Labyrinth seal.		Outer and inner V-rings.				
Lubrication		Permanently lubricated shielded bearings.					Valve lubrication.	
Terminal box	Material	Die-cast aluminum alloy. Base integrated with stator.		Deep-drawn steel sheet, bolted to stator.				
	Surface treatment	Similar to stator.		Phosphated. Polyester paint.				
	Screws	Steel 8.8, zinc electroplated						
Connections	Knock-out openings	2 x (2 x M40) + M16					2 x FL21	
	Flange-openings				2 x FL 13.2 x M40		2 x M63	
	Flange-openings				2 x FL 21.2 x M63 (voltage code S)		1 X M16	
	Terminal box	Cable lugs. 6 terminals.						
	Screws	M6			M10			
	Max Cu-area, mm ²	35			70			
Fan	Material	Polypropylene. Reinforced with 20% glass fibre.						
Fan cover	Material	Steel sheet. Galvanized.						
Stator winding	Material	Copper.						
	Impregnation	Polyester varnish.						
	Insulation class	Insulation class F. Temperature rise class B, unless otherwise stated.						
Stator winding temperature sensors		Optional. PTC-thermistors, 150°C						
Rotor winding		Die-cast aluminum.						
Balancing method		Half key balancing.						
Key ways		Closed keyway.						
Heating elements		25 W	50 W					
Drain holes		Drain holes with closable plastic plugs. Closed on delivery.						
Enclosure		IP 55.						
Cooling method		IC 411.						

Dust ignition proof aluminum motors in brief, basic design – 3D

Motor size		63	71	80	90	100	112	132
Stator	Material	Diecast aluminum alloy.						
	Paint colour shade	Munsell blue 8B 4.5/3.25 / NCS 4822-B05G.						
	Surface treatment	Polyester powder paint $\geq 30 \mu\text{m}$.						
Feet		Fixed feet.						
	Material	Aluminum alloy, integrated with stator.						
Bearing end shields	Material	Die-cast aluminum alloy.						
	Paint colour shade	Munsell blue 8B 4.5/3.25 / NCS 4822 B05G						
	Surface treatment	Polyester powder paint $\geq 30 \mu\text{m}$.						
Bearings	D-end	6202-2Z/C3	6203-2Z/C3	6204-2Z/C3	6205-2Z/C3	6306-2Z/C3	6306-2Z/C3	6208-2Z/C3 ¹⁾ 6308-2Z/C3 ²⁾
	N-end	6201-2Z/C3	6202-2Z/C3	6203-2Z/C3	6204-2Z/C3	6205-2Z/C3	6205-2Z/C3	6206-2Z/C3
		¹⁾ All types except ²⁾ SM_						
Axially-locked bearings		D-end with internal retaining ring			D-end with inner bearing cover.			
Bearing seal	D-end	V-ring.						
	N-end	Labyrinth seal.						
Lubrication		Permanently lubricated bearings. Grease temperature range -40 to +160°C.						
Terminal box	Material	Die-cast aluminum alloy, base integrated with stator.						
	Surface treatment	Similar to stator.						
	Screws	Steel 8.8, zinc electroplated						
Connections	Knock-out openings	1 x (M16 x Pg11)	2 x (M20 + M20)		2 x (M20 + M25)		2 x (M20 + M25) ¹⁾ 2 x (M40 + M32 + M12) ²⁾	
	Terminal box	Cable lugs. 6 terminals.			Screw terminal. 6 terminals.			Cable lugs. 6 terminals.
	Max Cu-area, mm ²	2.5	4	6		10 ¹⁾ 32 ²⁾		
		¹⁾ All types except ²⁾ SM_						
Fan	Material	Aluminum fan.						
Fan cover	Material	Steel.						
Stator winding	Material	Copper.						
	Impregnation	Polyester varnish. Tropicalised.						
	Insulation class	Insulation class F.						
	Winding protection	Optional.						
Rotor winding	Material	Die-cast aluminum.						
Balancing method		Half key balancing.						
Key ways		Closed key way.						
Heating elements		8 W			25 W			
Drain holes		Drain holes with closable plastic plugs. Closed on delivery.						
External earthing bolt		As standard.						
Enclosure		IP 55.						
Cooling method		IC 411.						

Dust ignition proof aluminum motors in brief, basic design – 3D

Motor size		160	180	200	225	250	280	
Stator	Material	Diecast aluminum alloy.		Extruded aluminum alloy.				
	Paint colour shade	Munsell blue 8B 4.5/3.25 / NCS 4822 B05G						
	Surface treatment	Polyester powder paint $\geq 50 \mu\text{m}$.						
Feet	Material	Aluminum alloy, integrated with stator.		Aluminum alloy, bolted to the stator. Frame size 250, 2-pole, cast iron.			Cast iron	
	Material	Cast iron						
Bearing end shields	Material	Cast iron						
	Paint colour shade	Munsell blue 8B 4.5/3.25 / NCS 4822 B05G						
	Surface treatment	Polyester powder paint $\geq 50 \mu\text{m}$.						
Bearings	D-end	2-pole	6309-2Z/C3	6310-2Z/C3	6312-2Z/C3	6313-2Z/C3	6315-2Z/C3	6315-2Z/C3
		4-8 -pole						
	N-end	2-pole	6209-2Z/C3	6209-2Z/C3	6210-2Z/C3	6212-2Z/C3	6213-2Z/C3	6213-2Z/C3
		4-8 -pole						
Axially-locked bearings	Inner bearing cover	D-end						
Bearing seal	D-end	V-ring.		Outer and inner V-rings.				
	N-end	Labyrinth seal.		Outer and inner V-rings.				
Lubrication		Permanently lubricated shielded bearings.						Valve lubrication.
Terminal box	Material	Die-cast aluminum alloy. Base integrated with stator.		Deep-drawn steel sheet, bolted to stator.				
	Surface treatment	Similar to stator.		Phosphated. Polyester paint.				
	Screws	Steel 8.8, zinc electroplated.						
Connections	Knock-out openings	2 x (2 x M40) + M16					2 x FL21	
	Flange-openings				2 x FL 13.2 x M40		2 x M63	
	Flange-openings				2 x FL 21.2 x M63 (voltage code S)		1 X M16	
	Terminal box	Cable lugs. 6 terminals.						
	Screws	M6			M10			
	Max Cu-area, mm ²	35			70			
Fan	Material	Polypropylene. Reinforced with 20% glass fibre.						
Fan cover	Material	Steel sheet. Galvanized.						
Stator winding	Material	Copper.						
	Impregnation	Polyester varnish.						
	Insulation class	Insulation class F. Temperature rise class B, unless otherwise stated.						
Stator winding temperature sensors		Optional. PTC-thermistors, 150°C						
Rotor winding		Die-cast aluminum.						
Balancing method		Half key balancing.						
Key ways		Closed keyway.						
Heating elements		25 W	50 W					
Drain holes		Drain holes with closable plastic plugs. Closed on delivery.						
Enclosure		IP 55.						
Cooling method		IC 411.						

ABB High voltage motor's product offer for explosive atmospheres

Flameproof motors

Type of protection: Ex d IIB/IIC T4, Ex de, IIB/IIC T4

Features: LV-11kV, 50/60 Hz, 2-18 poles, VSD applications, IP55, IC411, IC511, Horizontal or Vertical

Motor type	IEC frame size	Output kW
Ribs cooled	355 - 500	150 - 1250 kW
Tubes cooled	500 - 710	800 - 4500 kW

Pressurised motors

Type of protection: Ex px, Ex pxe; Temperature classes T1-T4, Gas groups A, B and C

Features: 50/60 Hz, 2-24 poles, VSD applications, acc. to ATEX Directive and IEC standards

Motor type	IEC frame size	Output kW
Induction motors	355 - 1120	up to 23 MW (31000 HP)
Synchronous motors	710 - 2500	up to 55 MW (74000 HP)

Increased safety motors

Type of protection: Ex e, Temperature classes T1-T3, Gas groups A, B and C

Features: 50/60 Hz, 2-24 poles, VSD applications, acc. to ATEX Directive and IEC Standards

Motor type	IEC frame size	Output kW
Induction motors	355 - 1120	up to 10 MW (13410 HP)

Non-sparking motors

Type of protection: Ex nA, T1-T4, Gas groups A,B and C

Features: 50/60 Hz, 2-24 poles, VSD applications, acc. to ATEX Directive and IEC Standards, CSA/US certified

Motor type	IEC frame size	Output kW
Induction motors	315 - 1120	up to 23 MW (31000 HP)
Synchronous motors	710 - 2500	up to 55 MW (74000 HP)

Motors for North America (NEC and CEC)

Type of protection: Class I Division 2, Class I Zone 2, Class II Division 2, Class III; T1-T4

Features: 50/60 Hz, 2-24 poles, VSD applications, designed for North American markets, CSA/US-certified

Motor type	IEC frame size	Output kW
Induction motors	315 - 1120	up to 23 MW (31000 HP)
Synchronous motors	710 - 2500	up to 55 MW (74000 HP)

More information for these motors
can be found from web-pages:
www.abb.com/motors&generators

Total product offer of ABB motors and generators



ABB manufacturers a comprehensive range of reliable and high efficiency motors and generators. We offer AC and DC motors, as well as synchronous motors and generators along with a complete portfolio of services. Our in-depth knowledge of virtually every type of industrial process ensures we can always specify the best solution for your needs.

Low voltage motors

- Process performance motors
- Industrial performance motors
- General performance motors

High voltage induction motors

- High voltage cast iron motors
- Induction modular motors
- Slip-ring modular motors

Motors and generators for explosive atmospheres

- Flameproof
- Increased safety
- Non-sparking
- Pressurized
- Dust ignition proof

Marine motors and generators

Synchronous motors

Generators

- Synchronous generators for diesel and gas engines
- Synchronous generators for steam and gas turbines
- Wind turbine generators

DC motors

Traction motors and generators

- High power traction motors
- Medium power traction motors
- Traction generators

Motors for other applications

- Low voltage open drip proof motors
- Low voltage brake motors
- Low voltage single phase motors
- Low voltage high ambient motors
- Permanent magnet motors and generators
- High speed motors
- Low voltage smoke venting motors
- Low voltage water cooled motors
- Motors for roller table drives
- Servo motors

Life cycle services

Visit our web site

www.abb.com/motors&generators

Motors and Generators

- > Low voltage motors
- > High voltage induction motors
- > **Motors and generators for explosive atmospheres**
- > DC motors
- > Synchronous Generators
- > Wind turbine generators
- > Synchronous motors
- > Traction motors
- > Servomotors
- > Service

The screenshot shows the ABB website's 'Motors and Generators' page. The header includes the ABB logo and navigation links like 'Home', 'About ABB', 'Products & services', 'News center', 'Careers', and 'Investor relations'. The main content area is titled 'Motors and Generators' and features a large image of a motor. Below this, there are sections for 'Our offering' with icons for 'Low Voltage Motors', 'Motors and Generators for Hazardous Areas', 'Synchronous Generators', 'Synchronous Motors', 'High Voltage Induction Motors', 'DC Motors', 'Wind Turbine Generators', and 'Traction Motors'. A right-hand sidebar contains a search bar, 'Products & Services only' filter, 'Rate this page', 'Share this page', 'Your preferences' (Finland, English), 'ABB contact for Finland' (Sales: Antti Korhonen, Service: Arto Keskkala), 'Downloads', and 'Links'.

The screenshot shows the ABB website's 'Motors for hazardous areas' page. The header is identical to the previous screenshot. The main content area is titled 'Motors for hazardous areas' and features a large image of a motor. Below this, there are sections for 'Our offering' with icons for 'Flameproof Motors', 'Increased Safety Motors', 'Dust Ignition Proof Motors', 'Pressurised Motors', 'Non-Sparking Motors', 'General', 'Certificate for Ex workshops', 'International standards', 'Certificates', 'News', 'Hazardous environment', 'Gas protection', and 'Dust ignition protection'. A right-hand sidebar contains a search bar, 'Products & Services only' filter, 'Rate this page', 'Share this page', 'Your preferences' (Finland, English), 'ABB contact for Finland' (Sales: Antti Korhonen, Service: Arto Keskkala), 'Downloads', and 'Links'.

The screenshot shows the ABB website's 'Low voltage flameproof motors' page. The header is identical to the previous screenshots. The main content area is titled 'Low voltage flameproof motors' and features a large image of a motor. Below this, there are sections for 'Overview', 'Documentation and downloads', and 'Type of protection: Ex d / Ex de - read more'. The 'Type of protection' section lists technical specifications: Output power (0.55 to 630 kW), Frame size (IEC 50 to 400), Number of poles (2 to 8), Voltages (All commonly used voltages), Frequency (50 or 60 Hz), Protection (IP 55), Protection type (For zone 1 or 2), Certificates (According to ATEX Directive and IEC standards), and Features (VSD applicable as standard, Variants for different standards in the oil and gas sector, Marine use and open deck with most classification societies). The 'Documentation and downloads' section includes a search bar, 'Please select category', and a list of documents: 'Environmental Product Declaration for MJP 180', 'Motors and Generators for Hazardous Areas EN 06-2006', 'Catalogue Motors for Hazardous Areas EN 01-2008', 'Certificate Certificate acc. to OHSAS 18001:1999, ABB Oy, Motors', 'Environmental Certificate ISO 14001:2004, ABB Oy, Motors', 'Production Quality Assessment Certificate for Cast iron motors for hazardous areas', and 'Production Quality Assessment Notification for Cast iron motors for hazardous areas'. A right-hand sidebar contains a search bar, 'Products & Services only' filter, 'Rate this page', 'Share this page', 'Your preferences' (Finland, English), 'ABB contact for Finland' (Sales: Antti Korhonen, Service: Arto Keskkala), 'Downloads', and 'Links'.

Contact us

www.abb.com/motors&generators

We reserve the right to make technical changes or modify the contents of this document without prior notice. With regard to purchase orders, the agreed particulars shall prevail. ABB Ltd does not accept any responsibility whatsoever for potential errors or possible lack of information in this document.

We reserve all rights in this document and in the subject matter and illustrations contained herein. Any reproduction, disclosure to third parties or utilization of its contents - in whole or in parts - is forbidden without prior written consent of ABB Ltd.

© Copyright 2010 ABB.
All rights reserved.

9AKK104006 EN 12-2010

Power and productivity
for a better world™

